

TP-LINK®

User Guide

TL-WA701ND

150Mbps Wireless N Access Point



COPYRIGHT & TRADEMARKS

Specifications are subject to change without notice. **TP-LINK®** is a registered trademark of TP-LINK TECHNOLOGIES CO., LTD. Other brands and product names are trademarks or registered trademarks of their respective holders.

No part of the specifications may be reproduced in any form or by any means or used to make any derivative such as translation, transformation, or adaptation without permission from TP-LINK TECHNOLOGIES CO., LTD. Copyright ©2015 TP-LINK TECHNOLOGIES CO., LTD.

All rights reserved.

<http://www.tp-link.com>

FCC STATEMENT



This equipment has been tested and found to comply with the limits for a Class B digital device, pursuant to part 15 of the FCC Rules. These limits are designed to provide reasonable protection against harmful interference in a residential installation. This equipment generates, uses and can radiate radio frequency energy and, if not installed and used in accordance with the instructions, may cause harmful interference to radio communications. However, there is no guarantee that interference will not occur in a particular installation. If this equipment does cause harmful interference to radio or television reception, which can be determined by turning the equipment off and on, the user is encouraged to try to correct the interference by one or more of the following measures:

- Reorient or relocate the receiving antenna.
- Increase the separation between the equipment and receiver.
- Connect the equipment into an outlet on a circuit different from that to which the receiver is connected.
- Consult the dealer or an experienced radio/ TV technician for help.

This device complies with part 15 of the FCC Rules. Operation is subject to the following two conditions:

- 1) This device may not cause harmful interference.
- 2) This device must accept any interference received, including interference that may cause undesired operation.

Any changes or modifications not expressly approved by the party responsible for compliance could void the user's authority to operate the equipment.

Note: The manufacturer is not responsible for any radio or tv interference caused by unauthorized modifications to this equipment. Such modifications could void the user's authority to operate the equipment.

FCC RF Radiation Exposure Statement

This equipment complies with FCC RF radiation exposure limits set forth for an uncontrolled environment. This device and its antenna must not be co-located or operating in conjunction with any other antenna or transmitter.

"To comply with FCC RF exposure compliance requirements, this grant is applicable to only Mobile Configurations. The antennas used for this transmitter must be installed to provide a separation distance of at least 20 cm from all persons and must not be co-located or operating in conjunction with any other antenna or transmitter."

CE Mark Warning



This is a class B product. In a domestic environment, this product may cause radio interference, in which case the user may be required to take adequate measures.

National restrictions

This device is intended for home and office use in all EU countries (and other countries following the EU directive 1999/5/EC) without any limitation except for the countries mentioned below:

Country	Restriction	Reason/remark
Bulgaria	None	General authorization required for outdoor use and public service
France	Outdoor use limited to 10 mW e.i.r.p. within the band 2454-2483.5 MHz	Military Radiolocation use. Refarming of the 2.4 GHz band has been ongoing in recent years to allow current relaxed regulation. Full implementation planned 2012
Italy	None	If used outside of own premises, general authorization is required
Luxembourg	None	General authorization required for network and service supply(not for spectrum)
Norway	Implemented	This subsection does not apply for the geographical area within a radius of 20 km from the centre of Ny-Ålesund
Russian Federation	None	Only for indoor applications

Note: Please don't use the product outdoors in France.

Industry Canada Statement:

This device complies with RSS-210 of the Industry Canada Rules. Operation is subject to the following two conditions:

- (1) This device may not cause harmful interference, and
- (2) This device must accept any interference received, including interference that may cause undesired operation.

IMPORTANT NOTE:

Radiation Exposure Statement:

This equipment complies with Canada radiation exposure limits set forth for an uncontrolled environment. This equipment should be installed and operated with minimum distance 20cm between the radiator & your body.

Ce dispositif est conforme à la norme CNR-210 d'Industrie Canada applicable aux appareils radio exempts de licence. Son fonctionnement est sujet aux deux conditions suivantes:

- (1) Le dispositif ne doit pas produire de brouillage préjudiciable, et
- (2) Ce dispositif doit accepter tout brouillage reçu, y compris un brouillage susceptible de provoquer un fonctionnement indésirable.

NOTE IMPORTANTE:

Déclaration d'exposition aux radiations:

Cet équipement est conforme aux limites d'exposition aux rayonnements IC établies pour un environnement non contrôlé. Cet équipement doit être installé et utilisé avec un minimum de 20 cm de distance entre la source de rayonnement et votre corps.

Korea Warning Statements:

당해 무선설비는 운용중 전파혼신 가능성이 있음.

NCC Notice:

經型式認證合格之低功率射頻電機，非經許可，公司、商號或使用者均不得擅自變更頻率、加大功率或變更原設計之特性及功能。

低功率射頻電機之使用不得影響飛航安全及干擾合法通信；經發現有干擾現象時，應立即停用，並改善至無干擾時方得繼續使用。前項合法通信，指依電信法規定作業之無線電通信。低功率射頻電機須忍受合法通信或工業、科學及醫療用電波輻射性電機設備之干擾。



Продукт сертифіковано згідно с правилами системи УкрСЕПРО на відповідність вимогам нормативних документів та вимогам, що передбачені чинними законодавчими актами України.

DECLARATION OF CONFORMITY

For the following equipment:

Product Description: **150Mbps Wireless N Access Point**

Model No.: **TL-WA701ND**

Trademark: **TP-LINK**

We declare under our own responsibility that the above products satisfy all the technical regulations applicable to the product within the scope of Council Directives:

Directives 1999/5/EC, Directives 2004/108/EC, Directives 2006/95/EC, Directives 1999/519/EC, Directives 2011/65/EU

The above product is in conformity with the following standards or other normative documents

ETSI EN 300 328 V1.8.1

ETSI EN 301 489-1 V1.8.1:2008& ETSI EN 301 489-17 V2.2.1

EN 55022:2010

EN 55024:2010

EN 61000-3-2:2006+A1:2009+A2:2009

EN 61000-3-3:2008

EN60950-1:2006+A11: 2009+A1:2010+A12:2011

EN62311:2008

The product carries the CE Mark:

CE 1588

Person is responsible for marking this declaration:



Yang Hongliang

Product Manager of International Business

Date of issue:2015

TP-LINK TECHNOLOGIES CO., LTD.

Building 24 (floors 1, 3, 4, 5), and 28 (floors 1-4) Central Science and Technology Park, Shennan Rd, Nanshan, Shenzhen, China

CONTENTS

Package Contents	1
Chapter 1 Introduction.....	2
1.1 Product Overview	2
1.2 Conventions	2
1.3 Main Features	3
1.4 Appearance.....	3
1.4.1 The Front Panel.....	3
1.4.2 The Rear Panel.....	4
Chapter 2 Hardware Installation	5
2.1 Before You Begin	5
2.2 Basic Requirements	5
2.3 Connecting the Device	5
Chapter 3 Quick Installation Guide.....	7
3.1 Quick Setup.....	7
Chapter 4 Configure the Device.....	18
4.1 Login	18
4.2 Status	19
4.3 Quick Setup.....	20
4.4 Operation Mode.....	20
4.5 WPS.....	21
4.6 Network	27
4.7 Wireless	28
4.7.1 Wireless Settings	28
4.7.2 Wireless Security.....	37
4.7.3 Wireless MAC Filtering	46
4.7.4 Wireless Advanced.....	49
4.7.5 Antenna Alignment	50
4.7.6 Throughput Monitor	50
4.7.7 Wireless Statistics.....	51
4.8 DHCP	51
4.8.1 DHCP Settings.....	52
4.8.2 DHCP Clients List.....	53
4.8.3 Address Reservation	53
4.9 System Tools.....	54
4.9.1 Time Settings.....	55
4.9.2 Diagnostic	56

4.9.3	Ping Watch Dog.....	58
4.9.4	Firmware Upgrade.....	58
4.9.5	Factory Defaults.....	59
4.9.6	Backup & Restore.....	59
4.9.7	Reboot.....	60
4.9.8	Password.....	61
4.9.9	System Log.....	61
4.9.10	Statistics.....	62
Appendix A: Application Example.....		65
Appendix B: Factory Defaults.....		68
Appendix C: Troubleshooting.....		69
Appendix D: Specifications.....		73
Appendix E: Glossary.....		74

Package Contents

- The following items should be found in your package:
- One TL-WA701ND 150Mbps Wireless N Access Point
- One Power Injector
- Ethernet Cable
- One Power Adapter for TL-WA701ND 150Mbps Wireless N Access Point
- Quick Installation Guide
- One Resource CD for TL-WA701ND 150Mbps Wireless N Access Point, including:
 - This User Guide
 - Other helpful information

 **Note:**

Make sure that the package contains the above items. If any of the listed items are damaged or missing, please contact with your distributor.

Chapter 1 Introduction

1.1 Product Overview

The TL-WA701ND 150Mbps Wireless N Access Point is dedicated to Small Office/Home Office (SOHO) wireless network solutions. It allows for greater range and mobility within your wireless network while also allowing you to connect the wireless devices to a wired environment. Increased mobility and the absence of cabling will be beneficial for your network.

With using IEEE 802.11n wireless technology, your device can transmit wireless data at the rate of up to 150Mbps. With multiple protection measures, including SSID broadcast control and wireless LAN 64/128/152-bit WEP encryption, WiFi protected Access (WPA2- PSK, WPA- PSK), the TL-WA701ND 150Mbps Wireless N Access Point delivers complete data privacy. This device leverages some 802.11n features to provide improved performance and coverage compared to 802.11a/g devices, and fully interoperates with 802.11n products if they are Wi-Fi CERTIFIED, but it does not conform to all of the requirements in the IEEE specification and is not classified as "n" in the Wi-Fi CERTIFIED program.

It supports an easy, web-based setup for installation and management. Even though you may not be familiar with the Access Point, you can easily configure it with the help of this Guide. Before installing the AP, please look through this Guide to get the full information of the TL-WA701ND 150Mbps Wireless N Access Point.

1.2 Conventions

The AP or TL-WA701ND, or device mentioned in this User guide stands for TL-WA701ND 150Mbps Wireless N Access Point without any explanations.

Parameters provided in the pictures are just references for setting up the product, which may differ from the actual situation. You can set the parameters according to your demand.

1.3 Main Features

- Wireless speed up to 150Mbps
- Supports Access Point, Multi-SSID, Client, Repeater (Universal Repeater) and Bridge with AP modes
- Up to 4 SSIDs and VLAN support
- Up to 30 meters (100 feet) of flexible deployment with included Power over Ethernet Injector
- Easily setup a WPA encrypted secure connection at a push of the WPS button
- Supports Remote and Web management
- Backward compatible with 802.11b/g products

1.4 Appearance

1.4.1 The Front Panel



Figure 1-1

The front panel of the TL-WA701ND consists of several LED indicators, which is designed to indicate connections. View from left to right, Table 1-1 describes the LEDs on the front panel of the device.

LED Explanation





Name	Status	Indication
	Off	No Power
	On	Power on
	Off	The device has a system error
	On	The device is initialising
	Flashing	The device is working properly
	Off	There is no device linked to the corresponding port
	On	There is a device linked to the corresponding port but no activity
	Flashing	There is an active device linked to the corresponding port
	Off	The Wireless function is disabled
	Flashing	The Wireless function is enabled
	Slow Flash	A wireless device is connecting to the network by WPS function. This process will last in the first 2 minutes.
	On	A wireless device has been successfully added to the network by WPS function.
	Quick Flash	A wireless device failed to be added to the network by WPS function.

Table 1-1

1.4.2 The Rear Panel

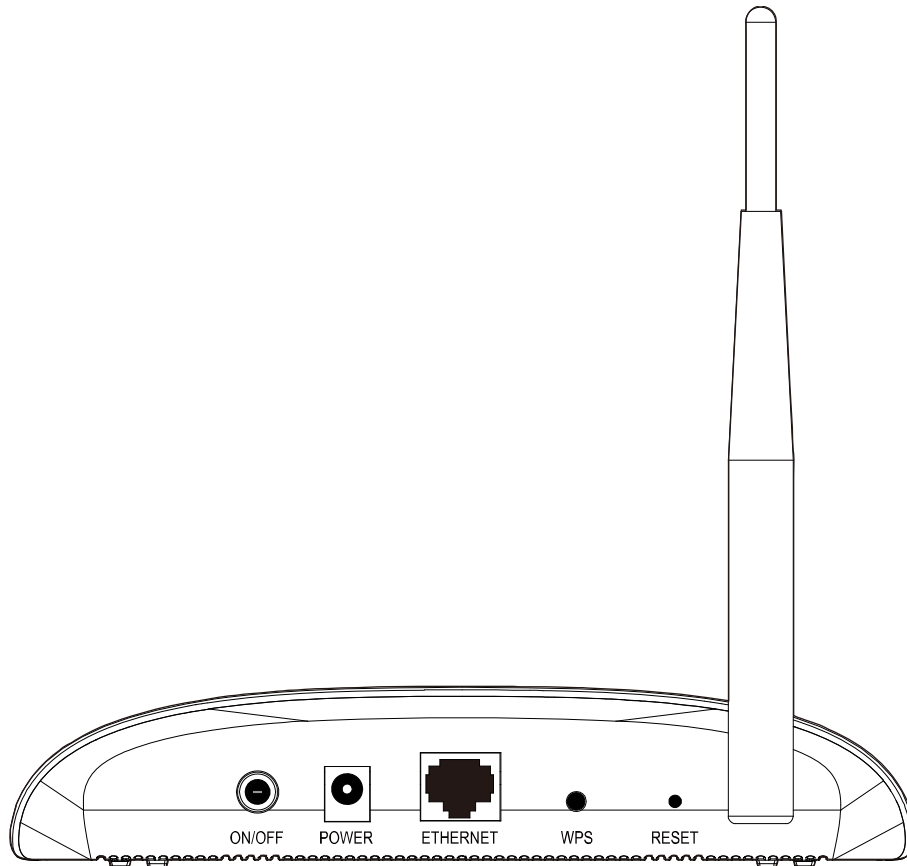

Figure 1-2

Viewed from left to right, the following parts are located on the rear panel of TL-WA701ND.

ON/OFF: The switch for the power.

POWER: The power port connects to the power adapter provided with the TL-WA701ND 150Mbps Wireless N Access Point.

Ethernet: One LAN 10/100Mbps RJ45 port connects to a network device, such as a switch or a router.

WPS: If you have client devices, such as wireless adapters, that support Wi-Fi Protected Setup, then you can press this button to quickly establish a connection between the device and client devices and automatically configure wireless security for your wireless network.

RESET: The Reset button is used to restore the AP's factory default settings. There are two ways to reset the Access Point's factory defaults:

- **Method one:** With the AP powered on, use a pin to press and hold the Reset button (about 5 seconds) until the System LED becomes quick-flash from slow-flash. And then release the button and wait the AP to reboot to its factory default settings.
- **Method two:** Restore the default settings from "**System Tools > Factory Defaults**" of the AP's Web-based management page.

Wireless antenna: The external antenna is used to transmit and receive wireless data.

 **Note:**

Ensure the AP is powered on before it restarts completely.

Chapter 2 Hardware Installation

2.1 Before You Begin

Please read this User Guide carefully before installing and using the equipment. The operating distance range of your wireless connection can vary significantly depending on the physical position of the wireless devices. Factors that can weaken signals by getting in the way of your network's radio waves are metal appliances or obstructions, and walls. Typical ranges vary base on the types of materials and background RF (radio frequency) noise in your home or office.

For best performance of your wireless network, you are suggested to:

- 1). Avoid redundant obstacles and interference between the wireless devices.
- 2). Keep your AP away from appliances with a strong electric field or magnetic field, such as a microwave oven or refrigerator.

Place the AP near the center of the area in which your computers operates.

2.2 Basic Requirements

- Use only the power adapter provided with your AP
- The electrical outlet shall be installed near the device and shall be easily accessible
- Place your AP in a well ventilated place far from direct sunlight, any heater or heating vent
- Leave at least 2 inches (5cm) space around the device for heat dissipation
- Turn off your AP and unplug the power adapter in a lighting storm to avoid damage
- Web browser, such as Microsoft Internet Explorer 5.0 or above, Netscape Navigator 6.0 or above
- Operating temperature: 0°C~40°C (32°F~104°F)
- Operating Humidity: 10%~90%RH, Non-condensing

2.3 Connecting the Device

Figure 2-1 is an example of the typical application of TL-WA701ND in the infrastructure network. An Infrastructure network contains an access point or a wireless router.

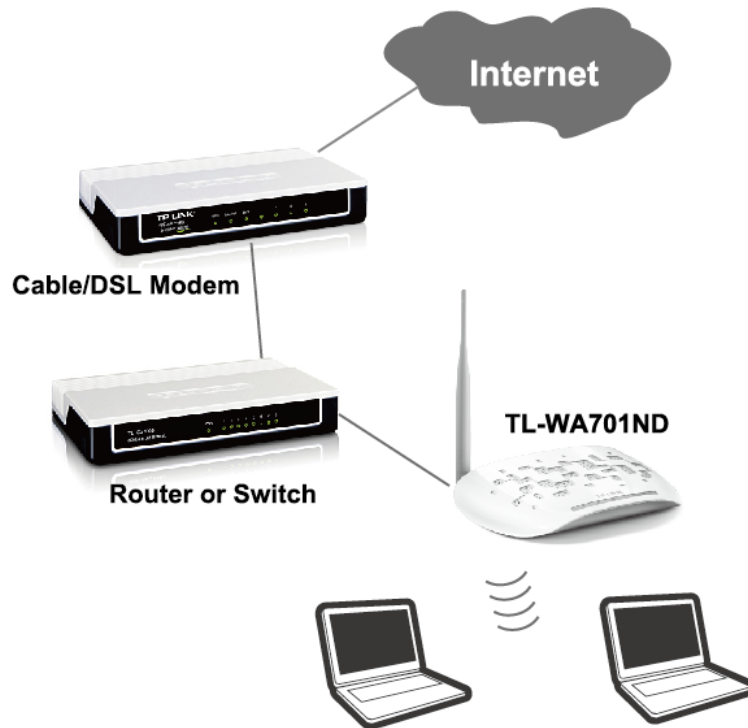

Figure 2-1 The Example of Infrastructure Network Incorporating the TL-WA701ND

To establish a typical connection of the AP, please take the following steps:

1. Connect the Cable or DSL modem to a Router.
2. Locate an optimum location for the AP. The best place is usually near the center of the area in which your PC(s) will wirelessly connect.
3. Adjust the direction of the antenna. Normally, upright is a good direction.
4. Connect the Ethernet Broadband Router to the TL-WA701ND Access Point. Power on the AP.
5. Then you can connect a desktop PC or laptop to your network. (Make sure your computer or laptop is equipped with a Wireless Adapter.)

 **Note:**

If you are not so clear about how to connect your devices to the network, please refer to [Appendix A Application Example](#).

Chapter 3 Quick Installation Guide

This chapter will guide you to configure your PC to communicate with the AP and to configure and manage the TL-WA701ND 150Mbps Wireless N Access Point easily with a Web-based utility.

3.1 Quick Setup

With a Web-based utility, it is easy to configure and manage the TL-WA701ND 150Mbps Wireless N Access Point. The Web-based utility can be used on any Windows, Macintosh or UNIX OS with a Web browser, such as Microsoft Internet Explorer, Mozilla Firefox or Apple Safari.

Note:

1. When first configure the TL-WA701ND, we suggest that the Local Area Connection of your computer is set as below.

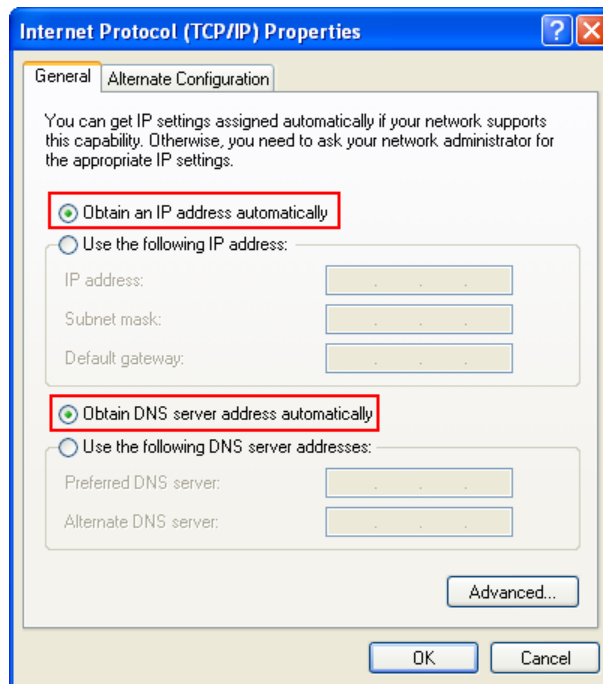

2. If you cannot access the web-based configuration page, you can choose the two methods listed below based on your need:
 - To reconfigure the TL-WA701ND, please refer to **T1** in **Troubleshooting** to reset the product.
 - To change only some certain settings of the TL-WA701ND, please refer to **T3** in **Troubleshooting** to assign a static IP address 192.168.0.100 for your computer.
1. To access the configuration utility, open a web-browser and type in the default address `http://192.168.0.254` in the address field of the browser.



Figure 3-1 Login to the AP

After a moment, a login window will appear, similar to the Figure 4-2. Enter **admin** for the User Name and Password (both in lower case letters). Then click **OK** or press Enter.

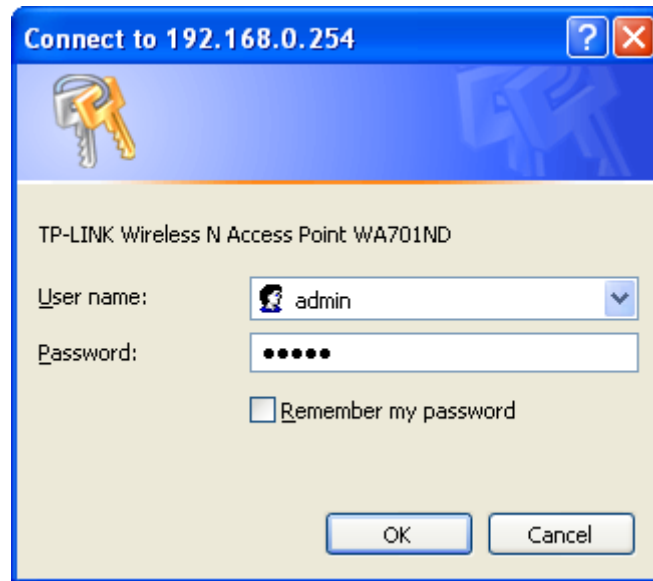

Figure 3-2 Login Windows

Note:

If the above screen does not prompt, it means that your web-browser has been set to a proxy. Go to **Tools menu>Internet Options>Connections>LAN Settings**, in the screen that appears, cancel the **Using Proxy** checkbox, and click **OK** to finish it.

2. After successfully logging in, the **Quick Setup** page will display. Click **Next** to continue.

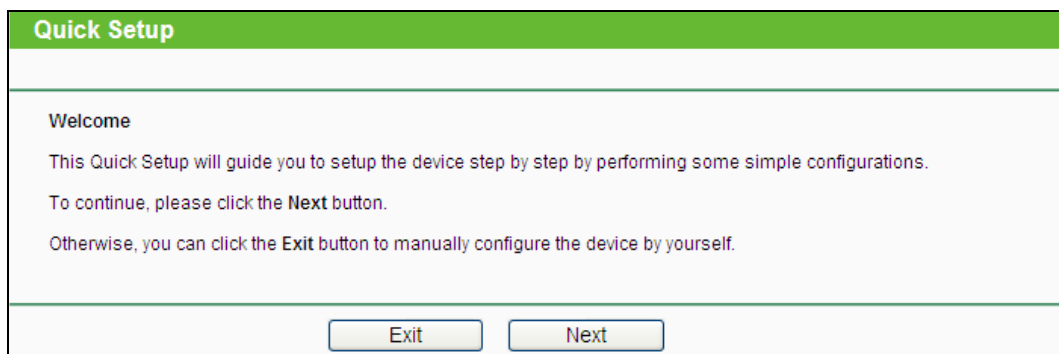

Figure 3-3 Quick Setup

Note:

If you click **Exit** and choose to manually configure the AP on your own need, please note that the DHCP is enabled during the configuration, it is essential to disable DHCP when all the settings are finished.

3. The **Operation Mode** page will appear then, shown in Figure 3-4. The TL-WA701ND supports up to five operation modes.

Operation Mode	Wireless Setting	Network Setting	Finish
Please select the proper operation mode according to your needs:			
<input checked="" type="radio"/> Access Point - Transform your existing wired network to a wireless network.			
<input type="radio"/> Multi-SSID - Create multiple wireless networks to provide different security and VLAN groups.			
<input type="radio"/> Repeater(Range Extender) - Extend your existing wireless coverage by relaying wireless signal.			
<input type="radio"/> Bridge with AP - Combine two local networks via wireless connection.			
<input type="radio"/> Client - Acting as a "Wireless Adapter" to connect your wired devices (e.g. Xbox/PS3) to a wireless network.			
<input type="button" value="Back"/>		<input type="button" value="Next"/>	

Figure 3-4 Operation Mode

- In **Access Point** mode, the product will act as a wireless central hub for your wireless LAN clients, giving a wireless extension for your current wired network.
 - In **Multi-SSID** mode, the product can be assigned up to four SSIDs to work with your VLAN.
 - In **Repeater(Range Extender)** mode, the product can extend the coverage of another wireless Access Point or Router. The universal repeater mode is for the wireless Access Point or Router which does not support WDS function.
 - In **Bridge with AP** mode, the product can wirelessly connect two or more remote LANs together.
 - In **Client** mode, the product will act as a wireless adapter to connect your wired devices (e.g. PC, Xbox, PS3, etc.) to a wireless network.
4. Select the operation mode based on your need.
- A. When you choose **Access Point** mode, the **Wireless Setting** page will be shown in Figure 3-5.

Operation Mode	Wireless Setting	Network Setting	Finish
Wireless Network Name(SSID): <input type="text" value="TP-LINK_57335F"/>			
Wireless Security Mode: <input type="button" value="Most Secure(WPA/WPA2-PSK)"/>			
Wireless Password: <input type="text"/>			
Enter an 8- to 63-character alphanumeric pass-phrase. For good security it should be of enough length and should not be a commonly known phrase.			
<input type="button" value="Back"/>		<input type="button" value="Next"/>	

Figure 3-5 Wireless Settings - Access Point mode

- 1) Create an easy-to-remember name for your wireless network, write it into **Wireless Network Name(SSID)**.
- 2) Select **Most Secure (WPA/WPA2-PSK)** encryption mode and enter a password below to prevent unauthorized access to your AP.

3) Click **Next**, you will then come to **Network Setting** page for further configuration.

B. When you choose **Multi-SSID** mode, the **Wireless Setting** page will be shown in Figure 3-6.

Operation Mode	Wireless Setting	Network Setting	Finish
<input type="checkbox"/> Enable VLAN			
SSID1:	<input type="text" value="TP-LINK_57335F"/>	VLAN ID:	<input type="text" value="1"/>
<input type="checkbox"/> SSID2:	<input type="text" value="TP-LINK_57335F_2"/>	VLAN ID:	<input type="text" value="1"/>
<input type="checkbox"/> SSID3:	<input type="text" value="TP-LINK_57335F_3"/>	VLAN ID:	<input type="text" value="1"/>
<input type="checkbox"/> SSID4:	<input type="text" value="TP-LINK_57335F_4"/>	VLAN ID:	<input type="text" value="1"/>
SSID:	<input type="text" value="TP-LINK_57335F"/>		
Wireless Security Mode:	<input type="text" value="Most Secure(WPA/WPA2-PSK)"/>		
Wireless Password:	<input type="text"/>		
Enter an 8- to 63-character alphanumeric pass-phrase. For good security it should be of enough length and should not be a commonly known phrase.			
<input type="button" value="Save"/>			
<input type="button" value="Back"/> <input type="button" value="Next"/>			

Figure 3-6 Wireless Settings – Multi-SSID mode

You are suggested to implement Multi-SSID function with a switch that supports Tag VLAN feature.

For advanced configuration of this step, please refer to explanations of this mode in [4.7.1 Wireless Settings](#).

C. When you choose **Repeater(Range Extender)** mode, the **Wireless Setting** page will be shown in Figure 3-7.

Operation Mode	Wireless Setting	Network Setting	Finish
Repeater Mode:	<input checked="" type="radio"/> Universal Repeater <input type="radio"/> WDS Repeater		
Wireless Name of Root AP:	<input type="text"/> (also called SSID)		
MAC Address of Root AP:	<input type="text"/>		
<input type="button" value="Survey"/>			
Click Survey button to scan the wireless networks, and choose the target one to setup.			
Wireless Security Mode:	<input type="text" value="Most Secure(WPA/WPA2-PSK)"/>		
All security settings, for example the wireless password should match the root AP/router.			
Wireless Password:	<input type="text"/>		
Enter an 8- to 63-character alphanumeric pass-phrase. For good security it should be of enough length and should not be a commonly known phrase.			
<input type="button" value="Back"/> <input type="button" value="Next"/>			

Figure 3-7 Wireless Settings – Repeater(Range Extender) mode

- 1) Select the **Repeater Mode**, for example Universal Repeater.
- 2) Click **Survey**, then the window displaying a list of available SSIDs will appear in Figure 3-8.

AP List						
AP Count: 39						
ID	BSSID	SSID	Signal	Channel	Security	Choose
1	80-80-80-80-80-81	ChinaNet-Ga5R	26dB	1	WPA-PSK	Connect
2	00-25-5E-1D-EE-77	ChinaNet-gvZZ	17dB	1	WPA2-PSK	Connect
3	B0-48-7A-41-A0-57	MERCURY_PocketAP_41A057	7dB	1	WPAWPA2-PSK	Connect
4	8C-21-0A-D9-51-1C	Network-8c210ad9511c	1dB	1	WPAWPA2-PSK	Connect
5	00-0A-EB-00-16-02	TP-LINK_001602	7dB	1	OFF	Connect
6	00-32-20-2B-03-03	TP-LINK_2B0303	19dB	1	OFF	Connect
7	F8-D1-11-42-34-DC	TP-LINK_4234DC	13dB	1	OFF	Connect
8	40-16-9F-61-BB-40	TP-LINK_61BB40	12dB	1	OFF	Connect
9	40-16-9F-BF-51-18	TP-LINK_8960V4-2	10dB	1	WPAWPA2-PSK	Connect
10	40-16-9F-BF-51-16	TP-LINK_8960V4_1	11dB	1	WPAWPA2-PSK	Connect
11	5C-63-BF-A4-92-8E	TP-LINK_A4928E	3dB	1	WPAWPA2-PSK	Connect
12	40-16-9F-BF-51-0E	TP-LINK_BF510E	25dB	1	OFF	Connect
13	30-48-7A-CE-48-BB	TP-LINK_CE48BB	4dB	1	OFF	Connect
14	14-E6-E4-FD-28-88	TP-LINK_FD2888	3dB	1	OFF	Connect
15	B6-D6-FF-54-B0-F2	hpsetup	4dB	1	OFF	Connect
16	00-04-ED-D1-CE-44	wlan-ap	12dB	1	OFF	Connect
17	F8-D1-11-24-EC-92	Rosewill_24EC92	45dB	4	OFF	Connect
18	94-0C-6D-2F-3C-BE	TP-LINK_Network1	51dB	5	WPA2-PSK	Connect
19	00-50-7F-6F-6D-C8	DrayTek	10dB	6	OFF	Connect
20	00-02-03-04-05-06	HGU	12dB	6	OFF	Connect
21	00-05-1D-03-04-07	IP-WDL-RT1T1R-B	8dB	6	OFF	Connect
22	00-0A-EB-13-7B-00	TP-LINK_137B00	18dB	6	OFF	Connect
23	00-0A-EB-13-09-18	TP-LINK_2.4GHz_130918	48dB	6	OFF	Connect
24	00-21-27-46-AD-1E	TP-LINK_46AD1C	18dB	6	OFF	Connect
25	40-16-9F-61-BB-7D	TP-LINK_61BB7D	30dB	6	OFF	Connect
26	00-19-CB-00-00-00	ZyXEL5952mw	18dB	7	OFF	Connect
27	54-E6-FC-B8-4F-74	qiaojie_25_2012	11dB	7	WPA2-PSK	Connect
28	AA-BB-CC-11-22-33	TP-LINK_112233	31dB	8	WPAWPA2-PSK	Connect
29	B0-48-7A-B9-46-30	Android_AAAA	10dB	9	WPAWPA2-PSK	Connect
30	10-9A-DD-85-2E-3B	apple_lee	16dB	10	WPA2-PSK	Connect
31	8C-21-0A-93-F1-A6		24dB	11	WPAWPA2-PSK	Connect
32	00-0A-EB-13-09-69	TP-LINK_130969	5dB	11	OFF	Connect
33	00-07-20-31-05-05	TP-LINK_310505	40dB	11	WPAWPA2-PSK	Connect
34	00-11-22-33-44-34	TP-LINK_334434	9dB	11	OFF	Connect
35	14-E6-E4-45-08-50	TP-LINK_450850	11dB	11	OFF	Connect
36	00-BB-CC-45-61-23	TP-LINK_456123	14dB	11	OFF	Connect
37	8C-21-0A-93-F2-04	TP-LINK_93F204	21dB	11	OFF	Connect
38	00-05-1D-03-04-05	TPLINK_030405	19dB	11	OFF	Connect
39	00-16-10-85-40-01	WPS7d35674001	22dB	11	WPAWPA2-PSK	Connect
<input type="button" value="Back"/> <input type="button" value="Refresh"/>						

Figure 3-8 AP List

- 3) Find the SSID of the Access Point / Router or WISP, and click **Connect** in the corresponding row. You will then return to the previous page.
 - 4) Select the security mode and enter the password that is the same as on your router or access point in Figure 3-7.
 - 5) Click **Next**, you will then come to **Network Setting** page for further configuration.
- D. When you choose **Bridge with AP** mode, the **Wireless Setting** page will be shown in Figure 3-9.

Operation Mode	Wireless Setting	Network Setting	Finish
<p>Wireless Name of Remote AP: <input type="text"/> (also called SSID)</p> <p>MAC Address of Remote AP: <input type="text"/></p> <p style="text-align: center;"><input type="button" value="Survey"/></p> <p style="text-align: center;"><small>Click Survey button to scan the wireless networks, and choose the target one to setup.</small></p> <p>Region: <input type="text" value="United States"/></p> <p>Warning: <small>Ensure you select a correct country to comply local law. Incorrect settings may cause interference.</small></p> <p>Channel: <input type="text" value="1"/></p> <p>Wireless Security Mode: <input type="text" value="Most Secure(WPA/WPA2-PSK)"/></p> <p style="text-align: center;"><small>All security settings, for example the wireless password should match the root AP/router.</small></p> <p>Wireless Password: <input type="text"/></p> <p style="text-align: center;"><small>Enter an 8- to 63-character alphanumeric pass-phrase. For good security it should be of enough length and should not be a commonly known phrase.</small></p> <p style="text-align: center;"> <input type="button" value="Back"/> <input type="button" value="Next"/> </p>			

Figure 3-9 Wireless Settings – Bridge with AP mode

- 1) Click **Survey**, then the window displaying a list of available SSIDs will appear in Figure 3-8.
- 2) Find the SSID of the Access Point / Router or WISP, and click **Connect** in the corresponding row. You will then return to the page shown in Figure 3-9.
- 3) Select the security mode and enter the password that is the same as on your router or access point.
- 4) Click **Next** in Figure 3-9, then the page below will appear. You can name the bridge AP in **Local Wireless Name**. With **Use the same security settings for the local wireless network as the root AP** selected, the security settings of the wireless network will be the same with the root AP.

Operation Mode	Wireless Setting	Network Setting	Finish
<p>Local Wireless Name: <input type="text" value="TP-LINK_57335F"/> (also called SSID)</p> <p><input checked="" type="checkbox"/> Use the same security settings for the local wireless network as the root AP</p> <p style="text-align: center;"> <input type="button" value="Back"/> <input type="button" value="Next"/> </p>			

Figure 3-10

 **Note:**

If you do not select **Use the same security settings for the local wireless network as the root AP**, the page will be shown as below, you can then separately configure the security settings for the local wireless network.

Operation Mode	Wireless Setting	Network Setting	Finish
Local Wireless Name: <input type="text" value="TP-LINK_57335F"/> (also called SSID)			
<input type="checkbox"/> Use the same security settings for the local wireless network as the root AP			
Wireless Security Mode: <input type="text" value="Most Secure(WPA/WPA2-PSK)"/>			
Wireless Password: <input type="text"/>			
Enter an 8- to 63-character alphanumeric pass-phrase. For good security it should be of enough length and should not be a commonly known phrase.			
<input type="button" value="Back"/>		<input type="button" value="Next"/>	

When the **Wireless Security Mode** in this page and in Figure 3-9 are both chosen **Secure(WEP)**, the security settings of the local wireless network will/shall keep the same with the root AP.

Wireless Security Mode:	<input type="text" value="Secure(WEP)"/>
Auth Type:	<input type="text" value="open"/>
Key Format:	<input type="text" value="ASCII"/>
WEP Index:	<input type="text" value="1"/>
Wireless Password:	<input type="text"/>

5) Click **Next** in Figure 3-10, and you will come to **Network Setting** page for further configuration.

E. When you choose **Client** mode, the **Wireless Setting** page will be shown in Figure 3-11.

Operation Mode	Wireless Setting	Network Setting	Finish
Wireless Name of Root AP: <input type="text"/> (also called SSID)			
MAC Address of Root AP: <input type="text"/>			
<input type="button" value="Survey"/>			
Click Survey button to scan the wireless networks, and choose the target one to setup.			
Wireless Security Mode: <input type="text" value="Most Secure(WPA/WPA2-PSK)"/>			
All security settings, for example the wireless password should match the root AP/router.			
Wireless Password: <input type="text"/>			
Enter an 8- to 63-character alphanumeric pass-phrase. For good security it should be of enough length and should not be a commonly known phrase.			
<input type="button" value="Back"/>		<input type="button" value="Next"/>	

Figure 3-11 Wireless Settings –Client mode

- 1) Click **Survey**, then the window displaying a list of available SSIDs will appear in Figure 3-8.
- 2) Find the SSID of the Access Point / Router or WISP, and click **Connect** in the corresponding row. You will then return to the page shown in Figure 3-11.
- 3) Select the security mode and enter the password that is the same as on the root AP.
- 4) Click **Next**, you will then come to **Network Setting** page for further configuration.
5. When you have configured Wireless Settings in step 4, The **Network Setting** page will appear then, shown in Figure 3-12. It is recommended that you keep the default settings on this page.

Operation Mode	Wireless Setting	Network Setting	Finish
<p>DHCP Server: <input checked="" type="radio"/> Disable <input type="radio"/> Enable</p> <p style="font-size: small;">In most of the cases your root AP/router has enabled DHCP server function, we highly recommended that you disable DHCP server function on this device to void any unpredictable problems.</p>			
<p>IP Address: <input type="text" value="192.168.0.254"/></p> <p>Subnet Mask: <input type="text" value="255.255.255.0"/> ▼</p> <p style="font-size: small;">We recommend you configure this AP with the same IP subnet and subnet mask, but different IP address from your root AP/Router.</p>			
<p>Change the login account: <input checked="" type="radio"/> NO <input type="radio"/> YES</p>			
<p><input type="button" value="Back"/> <input type="button" value="Next"/></p>			

Figure 3-12 Network Settings

Note:

1. These settings are only for basic wireless parameters, for advanced settings, please refer to [Section 4.7 Wireless](#).
 2. To change to another mode, please refer to **T3** in **Troubleshooting** to assign a static IP address 192.168.0.100 for your computer first before logging in the management page.
6. Click the **Next** button. You will then see the **Finish** page. Here takes the settings for Access Point mode for example.
- Because there is something changed of the configuration, you will see the **Finish** page as shown in Figure 3-13. Check your settings and click **Save** to save your settings for future reference.

Operation Mode	Wireless Setting	Network Setting	Finish
<p>Confirm the configuration you have set. If anything is wrong, please go BACK to reset. When confirmed, please click Finish/Reboot button to make all configurations take effect.</p>			
<h3>Wireless Setting</h3> <p>Operation Mode: Access Point</p> <p>Wireless Network Name(SSID): TP-LINK_57335F</p> <p>Wireless Security Mode: Most Secure(WPA/WPA2-PSK)</p> <p>Wireless Password: 1234567890</p>			
<h3>Network Setting</h3> <p>Login Account: admin/ admin</p> <p>LAN IP Address: 192.168.0.254</p> <p>DHCP Server: Disabled</p> <p><input type="button" value="Save"/> Save these settings as a text file for future reference</p>			
<p><input type="button" value="Back"/> <input type="button" value="Reboot"/></p>			

Figure 3-13 Quick Setup – Finish

Click the **Reboot** button to make your wireless configuration to take effect and finish the **Quick Setup**. Wait until the device restarts successfully.

Restart
<p>Configuration Completed Successfully.</p> <p>Restarting...</p> <p>26% </p>

Figure 3-14 Quick Setup – Finish

- If you don't make any changes of the configuration, you will see the **Finish** page as shown in Figure 3-15. Check your settings and click **Save** to save your settings for future reference. Click the **Finish** button to finish the **Quick Setup**.

Operation Mode	Wireless Setting	Network Setting	Finish
<p>Confirm the configuration you have set. If anything is wrong, please go BACK to reset. When confirmed, please click Finish/Reboot button to make all configurations take effect.</p>			
<p>Wireless Setting</p> <p>Operation Mode: Access Point</p> <p>Wireless Network Name(SSID): TP-LINK_57335F</p> <p>Wireless Security Mode: Most Secure(WPA/WPA2-PSK)</p> <p>Wireless Password: 1234567890</p>			
<p>Network Setting</p> <p>Login Account: admin/ admin</p> <p>LAN IP Address: 192.168.0.254</p> <p>DHCP Server: Disabled</p> <p><input type="button" value="Save"/> Save these settings as a text file for future reference</p>			
<p><input type="button" value="Back"/> <input type="button" value="Finish"/></p>			

Figure 3-15 Quick Setup – Finish

Chapter 4 Configure the Device

This Chapter describes how to configure your Access Point via the web-based management page. The TL-WA701ND 150Mbps Wireless N Access Point is easy to configure and manage with the Web-based (Internet Explorer, Netscape® Navigator, Firefox, Safari, Opera or Chrome) management page, which can be launched on any windows, Macintosh or UNIX OS with a web browser.

4.1 Login

Open your web browser. Type in IP address *http://192.168.0.254* in the address field of web browser and press Enter.



Figure 4-1 Login to the AP

Enter **admin** for the User Name and Password (both in lower case letters) in Figure 4-2 below. Then click **OK** or press Enter.

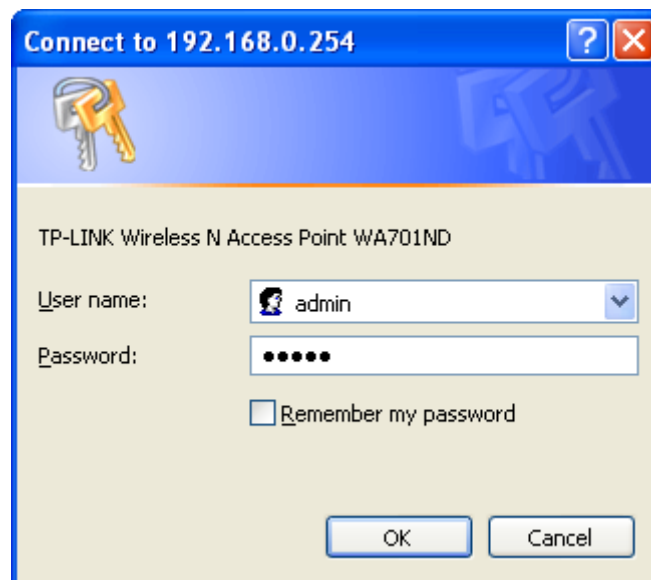

Figure 4-2 Login Windows

Note:

If the above screen does not prompt, it means that your web-browser has been set to a proxy. Go to **Tools menu>Internet Options>Connections>LAN Settings**, in the screen that appears, cancel the **Using Proxy** checkbox, and click **OK** to finish it.

After a successful login, you can configure and manage the device. There are six main menus on the leftmost column of the web-based management page: **Status**, **WPS**, **Network**, **Wireless**, **DHCP** and **System Tools**. Submenus will be available after clicking one of the main menus. On the right of the web-based management page lies the detailed explanations and instructions for the corresponding page.

4.2 Status

Selecting **Status** will enable you to view the AP's current status and configuration, all of which is read-only.

Status		
Firmware Version:	3.12.11 Build 120409 Rel.31574n	
Hardware Version:	WA701ND v2 00000000	
Wired		
MAC Address:	6C-FD-B9-57-33-5F	
IP Address:	192.168.0.254	
Subnet Mask:	255.255.255.0	
Wireless		
Operation Mode:	Access Point	
Name (SSID):	TP-LINK_57335F	
Channel:	Auto (Current channel 11)	
Mode:	11bgn mixed	
Channel Width:	Automatic	
MAC Address:	6C-FD-B9-57-33-5F	
Traffic Statistics		
	Received	Sent
Bytes:	0	12920
Packets:	0	35
System Up Time:	0 days 00:00:42	
	<input type="button" value="Refresh"/>	

Figure 4-3 Device Status

- **Firmware Version** - This field displays the current firmware version of the AP.
- **Hardware Version** - This field displays the current hardware version of the AP
- **Wired** - This field displays the current settings or information for the Network, including the **MAC address**, **IP address** and **Subnet Mask**.
- **Wireless** - This field displays basic information or status for wireless function, including **Operating Mode**, **SSID**, **Channel**, **Mode**, **Channel Width**, **Max Tx Rate** and **MAC Address**.
- **Traffic Statistics** - This field displays the AP's traffic statistics.
- **System Up Time** - This field displays the run time of the AP since it's powered on or reset.

 **Note:**

If you select Client mode in Figure 4-12, the wireless status in Figure 4-3 will change, similar to the figure below:

Wireless	
Operation Mode:	Client
Name (SSID):	TP-LINK_Network1
Signal:	44db
Channel:	4
Channel Width:	Automatic
MAC Address:	6C-FD-B9-57-33-5F

4.3 Quick Setup

Please refer to Section [3.1 Quick Setup](#) for more details.

4.4 Operation Mode

The **Operation Mode** option allows you to change the operation mode for your AP, shown in [Figure 4-4](#).

Operation Mode

Please select the proper operation mode according to your needs:

- Access Point** - Transform your existing wired network to a wireless network.
- Multi-SSID** - Create multiple wireless networks to provide different security and VLAN groups.
- Repeater(Range Extender)** - Extend your existing wireless coverage by relaying wireless signal.
- Bridge with AP** - Combine two local networks via wireless connection.
- Client** - Acting as a "Wireless Adapter" to connect your wired devices (e.g. Xbox/PS3) to a wireless network.

Figure 4-4 Operation Mode

- In **Access Point** mode, the product will act as a wireless central hub for your wireless LAN clients, giving a wireless extension for your current wired network.
- In **Multi-SSID** mode, the product can be assigned up to four SSIDs to work with your VLAN.
- In **Repeater (Range Extender)** mode, the product can extend the coverage of another wireless Access Point or Router. The universal repeater mode is for the wireless Access Point or Router which does not support WDS function.
- In **Bridge with AP** mode, the product can wirelessly connect two or more remote LANs together.
- In **Client** mode, the product will act as a wireless adapter to connect your wired devices (e.g. PC, Xbox, PS3, etc.) to a wireless network.

Select the operation mode based on your need, then click the **Save** button.

If the mode is changed, the Note Dialog will appear, shown as below. Click **OK**.

4.5 WPS

WPS (Wi-Fi Protected Setup) can help you to quickly and securely connect to a network. This section will guide you to add a new wireless device to an existing network quickly by function. The WPS function is only available when the Operation Mode is set to Access Point and Multi-SSID. Here we take the Access Point mode for example. Select menu **“WPS”**, you will see the next screen shown in Figure 4-5.

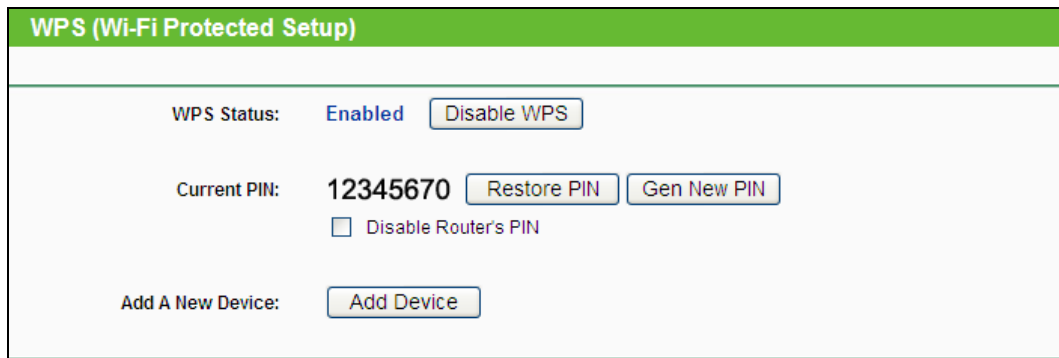

Figure 4-5 WPS

- **WPS Status** - To enable or disable the WPS function here.
- **Current PIN** - The current value of the device's PIN is displayed here. The default PIN of the device can be found in the label or User Guide.
- **Restore PIN** - Restore the PIN of the device to its default.
- **Gen New PIN** - Click this button, and then you can get a new random value for the device's PIN. You can ensure the network security by generating a new PIN.
- **Disable Router's PIN** - WPS external register of entering the device's PIN can be disabled or enabled manually. If the device receives multiple failed attempts to authenticate an external Register, this function will be disabled automatically.
- **Add Device** - You can add a new device to the existing network manually by clicking this button.

To add a new device:

If the wireless adapter supports Wi-Fi Protected Setup (WPS), you can establish a wireless connection between wireless adapter and device using either Push Button Configuration (PBC) method or PIN method.

Note:

To build a successful connection by WPS, you should also do the corresponding configuration of the new device for WPS function meanwhile.

For the configuration of the new device, here takes the Wireless Adapter of our company for example.

I. By PBC

If the wireless adapter supports Wi-Fi Protected Setup and the Push Button Configuration (PBC) method, you can add it to the network by PBC with the following two methods.

Method One:

Step 1: Press the WPS button on the rear panel of the device.

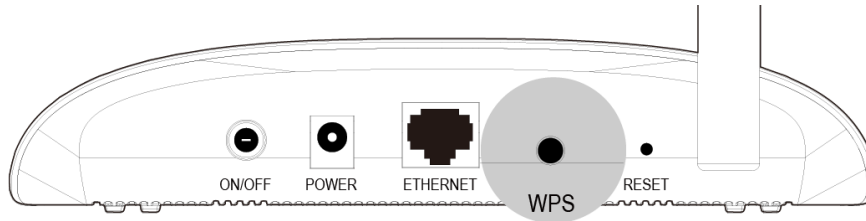

Step 2: Press and hold the WPS button of the adapter directly for 2 or 3 seconds.

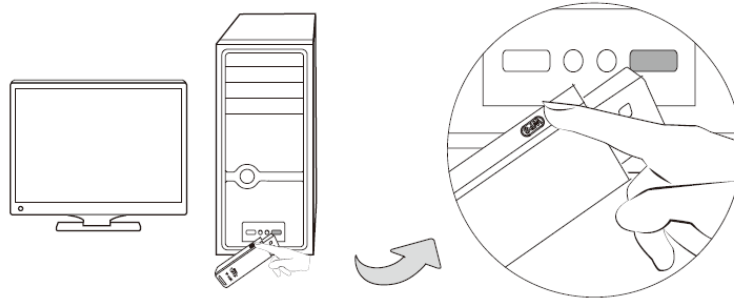

Step 3: Wait for a while until the next screen appears. Click **Finish** to complete the WPS configuration.

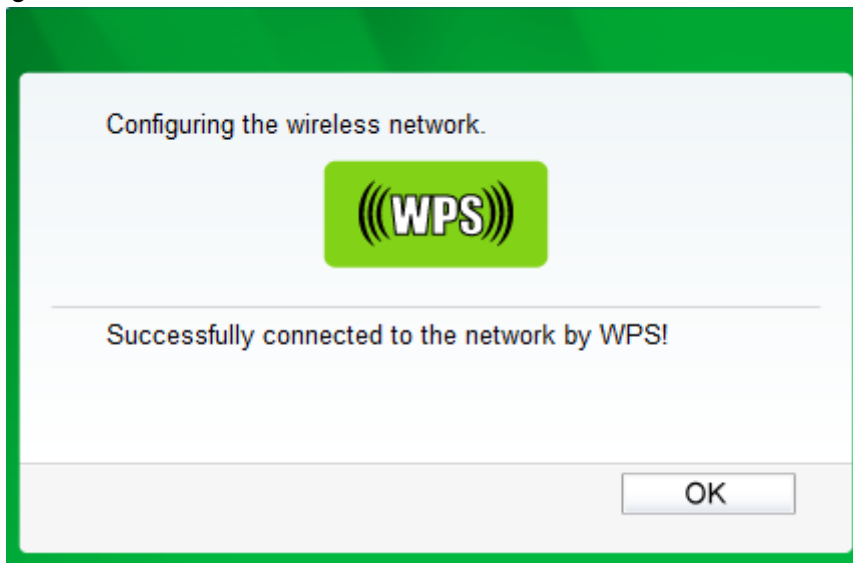

The WPS Configuration Screen of Wireless Adapter

Method Two:

Step 1: Press the WPS button on the rear panel of the device.

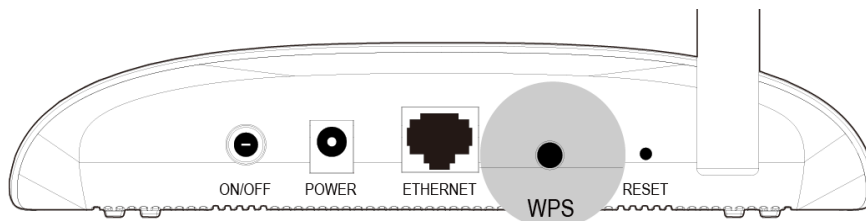

Step 2: For the configuration of the wireless adapter, please choose “**Push the button on my access point**” in the configuration utility of the WPS as below, and click **Next**.

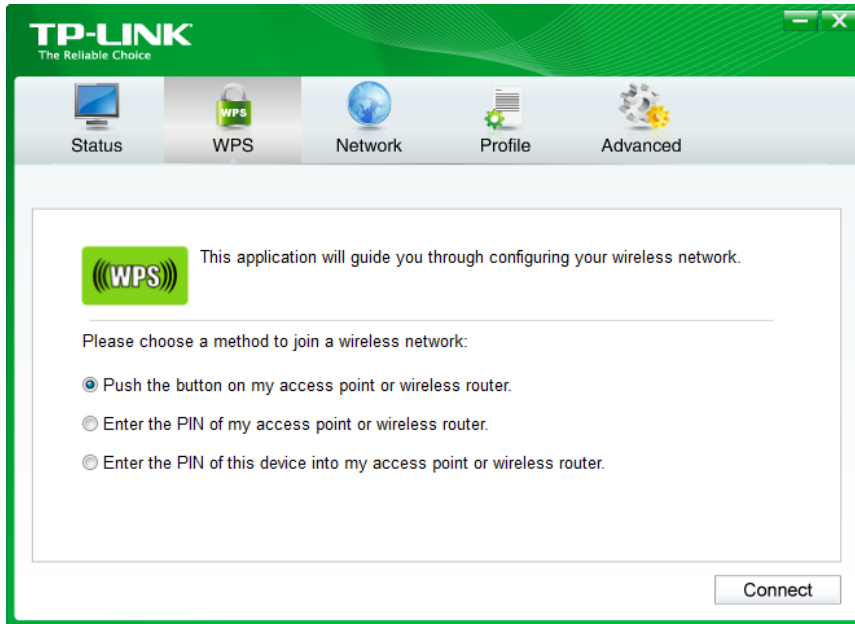

The WPS Configuration Screen of Wireless Adapter

Step 3: Wait for a while until the next screen appears. Click **Finish** to complete the WPS configuration.



The WPS Configuration Screen of Wireless Adapter

Method Three:

Step 1: Keep the default WPS Status as **Enabled** and click the **Add device** button in Figure 4-5, then the following screen will appear.

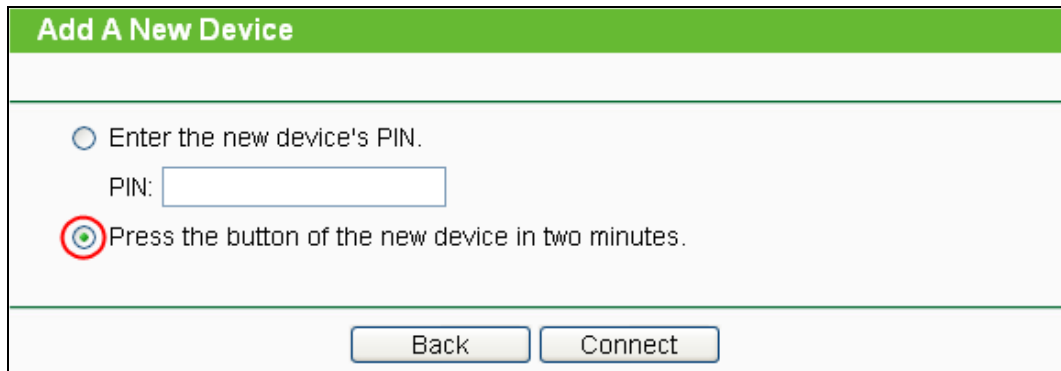

Add A New Device

Enter the new device's PIN.
PIN:

Press the button of the new device in two minutes.

Figure 4-6 Add A New Device

Step 2: Choose **“Press the button of the new device in two minutes”** and click **Connect**.

Step 3: For the configuration of the wireless adapter, please choose **“Push the button on my access point or wireless router”** in the configuration utility of the WPS as below, and click **Next**.

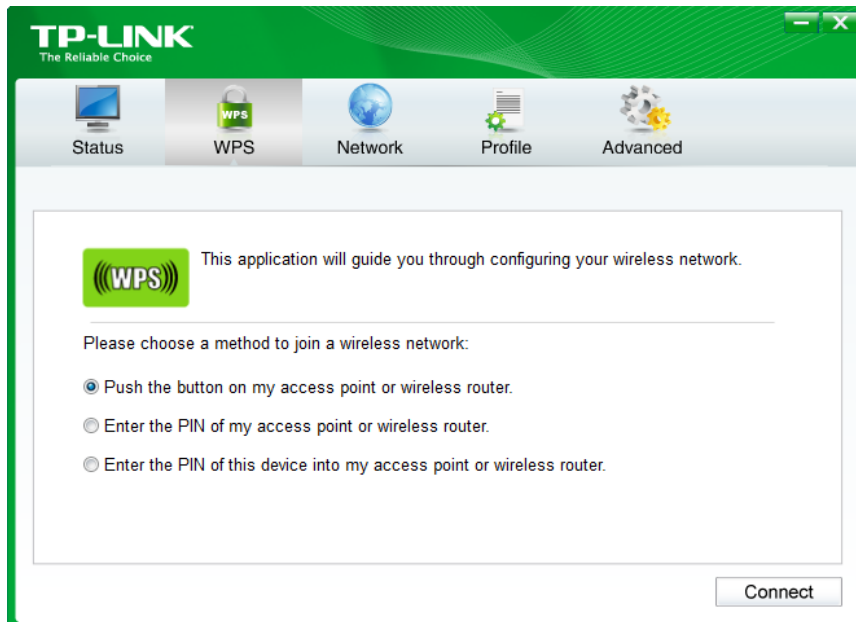

TP-LINK
The Reliable Choice

Status WPS Network Profile Advanced

WPS This application will guide you through configuring your wireless network.

Please choose a method to join a wireless network:

Push the button on my access point or wireless router.

Enter the PIN of my access point or wireless router.

Enter the PIN of this device into my access point or wireless router.

The WPS Configuration Screen of Wireless Adapter

Step 4: Wait for a while until the next screen appears. Click **Finish** to complete the WPS configuration.



The WPS Configuration Screen of Wireless Adapter

II. By PIN

If the new device supports Wi-Fi Protected Setup and the PIN method, you can add it to the network by PIN with the following two methods.

Method One: Enter the PIN into my AP

Step 1: Keep the default WPS Status as **Enabled** and click the **Add device** button in Figure 4-5, then the following screen will appear.

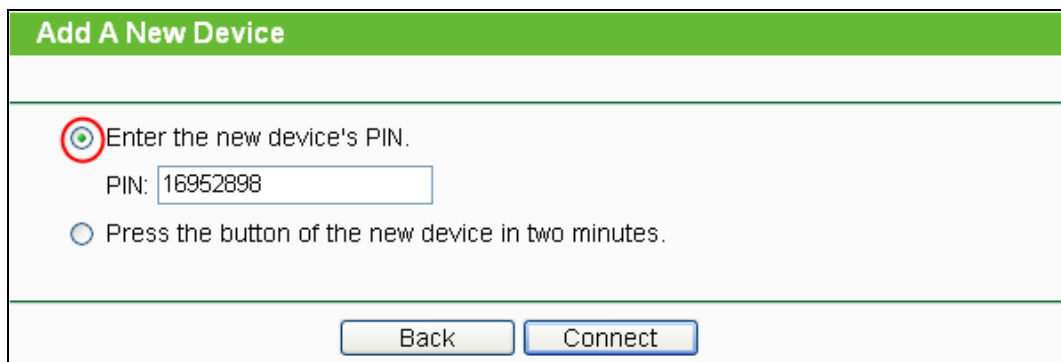

Figure 4-7 Enter the PIN

Step 2: Choose “**Enter the new device's PIN**” and enter the PIN code (take 16952898 for example) of the wireless adapter in the field after **PIN** as shown in the figure above. Then click **Connect**.

Note:

The PIN code of the adapter is always displayed on the WPS configuration screen as shown in the following figure.

Step 3: For the configuration of the wireless adapter, please choose “**Enter the PIN of my access point or wireless router.**” in the configuration utility of the WPS as below, and click **Next**.



The WPS Configuration Screen of Wireless Adapter

Note:

In this example, the default PIN code of this adapter is 16952898 as the above figure shown.

Method Two: Enter the PIN from my AP

- Step 1: Get the Current PIN code of the AP in Figure 4-5 (each AP has its unique PIN code. Here takes the PIN code 12345670 of this AP for example).
- Step 2: For the configuration of the wireless adapter, please choose “**Enter a PIN from my access point**” in the configuration utility of the WPS as below, and enter the PIN code of the AP into the field after “**Access Point PIN**”. Then click **Next**.



The WPS Configuration Screen of Wireless Adapter

Note:

The default PIN code of the AP can be found in its label or the WPS configuration screen as Figure 4-5 .

You will see the following screen when the new device has successfully connected to the network.

Note:

1. The WPS LED on the AP will light green for five minutes if the device has been successfully added to the network.
2. The WPS function cannot be configured if the Wireless function of the AP is disabled. Please make sure the Wireless function is enabled before configuring the WPS.

4.6 Network

The **Network** option allows you to customize your local network manually by changing the default settings of the AP.

Selecting **Network** will enable you to configure the IP parameters of Network on this page.

Figure 4-8 Network

- **Type** - Select **Dynamic IP** to get IP address from DHCP server or select **Static IP** to configure IP address manually from the drop-down list.
- **IP Address** - Enter the IP address of your AP in dotted-decimal notation (factory default setting is 192.168.0.254).
- **Subnet Mask** - An address code that determines the size of the network. Normally use 255.255.255.0 as the subnet mask.
- **Gateway** - The gateway should be in the same subnet as your IP address.
- **MAC Address** - The physical address of the AP. The value can't be changed.

Note:

1. If you change the IP Address, you must use the new IP Address to log in the AP.
2. If the new LAN IP Address you set is not in the same subnet with the IP Address pool of DHCP sever, the IP Address pool will not take effect until it is re-configured accordingly.

4.7 Wireless

The **Wireless** option, improving functionality and performance for wireless network, can help you make the AP an ideal solution for your wireless network. Here you can create a wireless local area network just through a few settings. Wireless Settings is used for the configuration of some basic parameters of the AP. Wireless Security provides three different security types to secure your data and thus provide greater security for your wireless network. MAC filtering allows you to control the access of wireless stations to the AP. Wireless Advanced allows you to configure some advanced parameters for the AP. Throughput Monitor helps to watch wireless throughput information. Wireless statistics enables you to get detailed information about the current connected wireless stations.

There are six submenus under the Wireless menu (shown in Figure 4-9): **Wireless Settings**, **Wireless Security**, **Wireless MAC Filtering**, **Wireless Advanced**, **Antenna Alignment**, **Throughput Monitor** and **Wireless Statistics**. Click any of them, and you will be able to configure the corresponding function. The detailed explanations for each submenu are provided below.

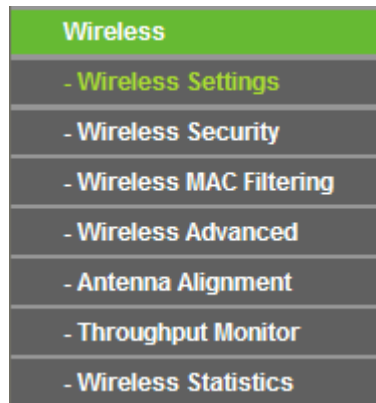

Figure 4-9 Wireless menu

4.7.1 Wireless Settings

Selecting **Wireless > Wireless Settings** will enable you to configure the basic settings for your wireless network on the screen below (Figure 4-10). This page allows you to configure the wireless mode for your device. Six operation modes are supported here, including **Access Point**, **Multi-SSID**, **Client**, **Repeater (Range Extender)** and **Bridge with AP**. The available setting options for each operation mode are different from those of the other.

1) **Access Point:** This mode allows wireless stations to access this device.

Figure 4-10 Wireless Settings in Access Point mode

- **SSID** (Set Service Identifier) - Identifies your wireless network name. Create a name up to 32 characters and make sure all wireless points in the wireless network with the same SSID. The default SSID is TP-LINK_XXXXXX (XXXXXX indicates the last unique six characters of each device's MAC address). This value is case-sensitive. For example, *TEST* is NOT the same as *test*.
- **Region** - Select your region from the pull-down list. This field specifies the region where the wireless function of the device can be used. It may be illegal to use the wireless function of the device in a region other than one of those specified in this field. If your country or region is not listed, please contact your local government agency for assistance.

When you select your local region from the pull-down list, click the **Save** button, then the Note Dialog appears. Click **OK**.

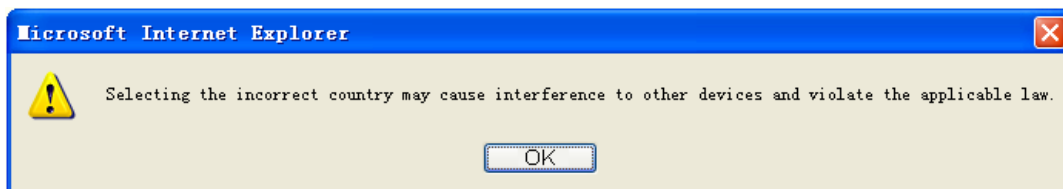

Note Dialog

Note:

Limited by local law regulations, version for North America does not have region selection option.

- **Channel** - Determines the operating frequency to be used. It is not necessary to change the wireless channel unless you notice interference problems with another nearby access point.
- **Mode** - Select the desired wireless mode. The options are:
 - **11b only** - Only 802.11b wireless stations can connect to the device.
 - **11g only** - Only 802.11g wireless stations can connect to the device.
 - **11n only** - Only 802.11n wireless stations can connect to the device.
 - **11bg mixed** - Both 802.11b and 802.11g wireless stations can connect to the device.

- **11bgn mixed** - All 802.11b, 802.11g and 802.11n wireless stations can connect to the device.
- **Channel Width** - Determines the channel width to be used. It is unnecessary to change the default value unless required.
- **Enable Wireless Radio** - Select or deselect this check box to allow or deny wireless stations to access the device.
- **Enable SSID Broadcast** - Select or deselect this check box to allow or deny the device to broadcast its name (SSID) on the air. If it's allowed, when wireless clients survey the local area for wireless networks to associate with, they will detect the SSID broadcast by the device.

Note:

To apply any settings you have altered on the page, please click the **Save** button, and then you will be reminded to reboot the device.

2) **Multi-SSID:** This mode allows the device to support up to four SSIDs.

The screenshot shows the 'Wireless Settings - Access Point' configuration interface. At the top, there is a green header with the title. Below it, the 'Enable VLAN' checkbox is unchecked. There are four rows for SSID configuration: SSID1 (TP-LINK_57335F), SSID2 (TP-LINK_57335F_2), SSID3 (TP-LINK_57335F_3), and SSID4 (TP-LINK_57335F_4). Each SSID has a corresponding 'VLAN ID' field set to 1. The 'Region' is set to 'United States' with a dropdown arrow. A warning message states: 'Ensure you select a correct country to comply local law. Incorrect settings may cause interference.' The 'Channel' is set to 'Auto', 'Mode' is '11bgn mixed', and 'Channel Width' is 'Auto'. At the bottom, there are two checked checkboxes: 'Enable Wireless Radio' and 'Enable SSID Broadcast'. A 'Save' button is located at the very bottom of the form.

Figure 4-11 Wireless Settings in Multi-SSID mode

- **Enable VLAN** - Check this box and then you can change the **VLAN ID** of each SSID. If you want to configure the Guest and Internal networks on VLAN, the switch you are using must support VLAN. As a prerequisite step, configure a port on the switch for handling VLAN tagged packets as described in the IEEE802.1Q standard, and enable this field.
- **SSID (1-4)** - Up to four SSIDs for each BSS (Basic Service Set) can be entered in the filed SSID1 ~ SSID4. The name can be up to 32 characters. The same name (SSID) must be assigned to all wireless devices in your network. If **Enable VLAN** is checked, the wireless stations connecting to SSID of different VLANID can not communicate with each other.

- **VLANID (1-4)** - Provide a number between 1 and 4095 for VLAN. This will cause the device to send packets with VLAN tags. The switch connecting with the device must support VLAN IEEE802.1Q frames. The wireless stations connecting to the SSID of a specified VLAN ID can communicate with the PC connecting to the port with the same VLAN ID on the Switch.
- **Region** - Select your region from the pull-down list. This field specifies the region where the wireless function of the device can be used. It may be illegal to use the wireless function of the device in a region other than one of those specified in this field. If your country or region is not listed, please contact your local government agency for assistance.

When you select your local region from the pull-down list, click the **Save** button, then the Note Dialog appears. Click **OK**.

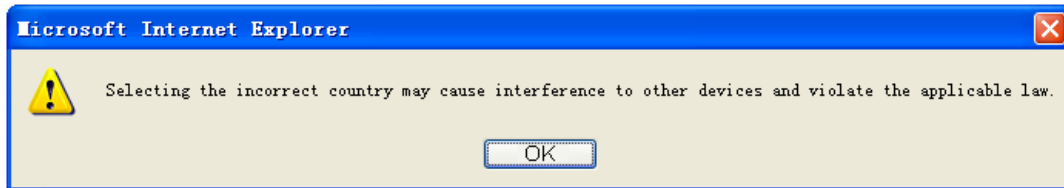

Note Dialog

 **Note:**

Limited by local law regulations, version for North America does not have region selection option.

- **Channel** - Determines the operating frequency to be used. It is not necessary to change the wireless channel unless you notice interference problems with another nearby access point.
- **Mode** - This field determines the wireless mode which the device works on.
 - **11b only** - Only 802.11b wireless stations can connect to the device.
 - **11g only** - Only 802.11g wireless stations can connect to the device.
 - **11n only** - Only 802.11n wireless stations can connect to the device.
 - **11bg mixed** - Both 802.11b and 802.11g wireless stations can connect to the device.
 - **11bgn mixed** - All 802.11b, 802.11g and 802.11n wireless stations can connect to the device.
- **Channel Width** - Determines the channel width to be used. It is unnecessary to change the default value unless required.
- **Enable Wireless Radio** - Select or deselect this check box to allow or deny wireless stations to access the device.
- **Enable SSID Broadcast** - Select or deselect this check box to allow or deny the device to broadcast its name (SSID) on the air. If it's allowed, when wireless clients survey the local area for wireless networks to associate with, they will detect the SSID broadcast by the device.

 **Note:**

To apply any settings you have altered on the page, please click the **Save** button, and then you will be reminded to reboot the device.

You are suggested to implement Multi-SSID function with a switch that supports Tag VLAN feature. Here is an example of how to configure Multi-SSID. Please take the following steps:

1. Configure the Access Point

Wireless Settings - Access Point

Enable VLAN

SSID1: VLAN ID:

SSID2: VLAN ID:

SSID3: VLAN ID:

SSID4: VLAN ID:

Region:

Warning: Ensure you select a correct country to comply local law. Incorrect settings may cause interference.

Channel:

Mode:

Channel Width:

Enable Wireless Radio

Enable SSID Broadcast

Configure the Access Point

- Select Multi-SSID as the operation mode of TL-WA701ND.
- Select the checkbox before Enable VLAN to enable VLAN function for this access point.
- Configure the SSID and its corresponding VLAN ID. The detailed parameters are shown as the above figure.
- STA1, STA2, STA3 and STA4 join to the wireless network with SSID1, SSID2, SSID3 and SSID4 respectively.
- Click **Save** to apply the current security settings for the selected SSID.

Note:

1. The wireless STAs join to the network with different VLAN IDs cannot communicate with each other, for example, STA1 and STA2.
2. The wireless STAs join to the network with the same VLAN ID can communicate with each other, for example, STA1 and STA3.
3. All wireless STAs can log on to the Web management page of TL-WA701ND and manage the access point, for example, STA1, STA2, STA3 and STA4.
4. All the packets received in the wired network from the wireless STA will be added a corresponding VLAN Tag of the wireless STA, unless the VLAN ID of the wireless network is set to 1.

2. Configure the Switch.

- Enable 802.1Q Tag VLAN function on the switch.
- Make sure the Untag frames are forwarded.

The following table shows the detailed configuration for the switch

Port	VLAN ID	PVID	Egress Rule	Processing mode of Utag Frames
1	1	1	Untag	Forwarding
2	2	2	Untag	Forwarding
3	3	3	Untag	Forwarding
4	4	4	Untag	Forwarding
5	Port5 belongs to all VLANs	1	Tag	Forwarding

Table 4-1 Configure the Tag VLAN Switch

- Connect PC1, PC2, PC3 and PC4 to port1, port2, port3 and port4 of the switch respectively. The corresponding VLAN IDs of the four ports are 1, 2, 3 and 4.
- Configure port5 of the switch to be the member of VLAN1, VLAN2, VLAN3 and VLAN4 and connect it to the LAN port of TL-WA701ND.
- Configure the VLAN ID of the PC that can log on to the Web management page of TL-WA701ND via the LAN port equal to the PVID of port 5.

3. Verify the communication status after the above configuration is completed.

- If VLAN ID of the PC connected to the switch is different from the VLAN ID of the wireless STA, the two cannot communicate with each other, for example, PC1 and STA2.
- If the PC connected to the switch and the wireless STA have the same VLAN ID, the two can communicate with each other, for example PC2 and STA2.

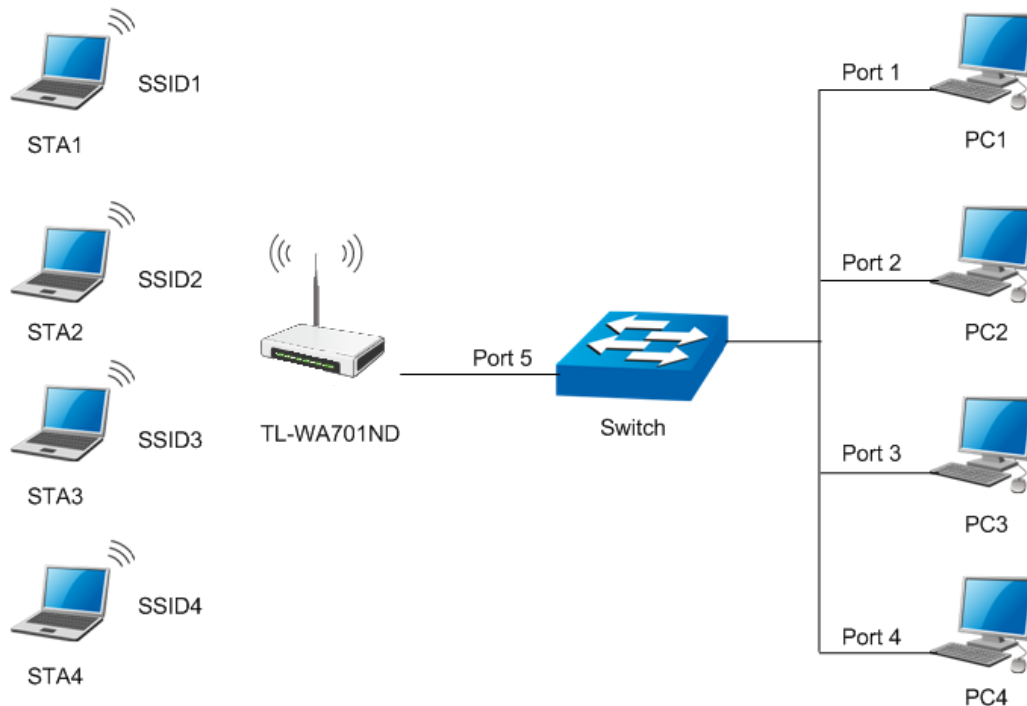

Multi-SSID+VLAN

Note:

If the LAN port of TL-WA701ND is not connected to a switch but directly to a PC,

1. The PC can directly log on to the Web management page of TL-WA701ND and manage the access point.
2. Only the wireless STA with its VLAN ID set to 1 can communicate with the wired PC.
- 3) **Client:** This mode allows the device to act as a wireless station to enable wired host(s) to access an AP.

Figure 4-12 Wireless Settings in Client mode

- **Wireless Name of Root AP** - If you select the radio button before **Wireless Name of Root AP**, the AP client will connect to the AP according to SSID. Enter the SSID of AP that you want to access.
- **MAC Address of Root AP** - If you select the radio button before **MAC Address of Root AP**, the AP client will connect to the AP according MAC address. Enter the MAC address of AP that you want to access.
- **Channel Width** - Determines the channel width to be used. It is unnecessary to change the default value unless required.
- **Enable Wireless Radio** - Select or deselect this check box to allow or deny wireless stations to access the device.

Click the **Survey** button to detect the SSIDs in the local area.

Note:

To apply any settings you have altered on the page, please click the **Save** button, and then you will be reminded to reboot the device.

- 4) **Repeater (Range Extender):** In this mode, the product can extend the coverage of another wireless Access Point or Router. The universal repeater mode is for the wireless Access Point or Router which does not support WDS function.

Wireless Settings - Repeater

Repeater Mode: Universal Repeater WDS Repeater

Wireless Name of Root AP: (also called SSID)

MAC Address of Root AP:

Channel Width:

Enable Wireless Radio

Figure 4-13 Wireless Settings in Repeater mode

- **Repeater Mode** - Select the mode based on your need.
 - **Universal Repeater** - In Repeater mode, the AP with WDS enabled will relays data to an associated root AP. AP function is enabled meanwhile. The wireless repeater relays signal between its stations and the root AP for greater wireless range.
 - **WDS Repeater** - In Universal Repeater mode, the AP with WDS disabled will relays data to an associated root AP. AP function is enabled meanwhile. The wireless repeater relays signal between its stations and the root AP for greater wireless range.
- **Wireless Name of Root AP** - If you select the radio button before **Wireless Name of Root AP**, the AP client will connect to the AP according to SSID. Enter the SSID of AP that you want to access.
- **MAC Address of Root AP** - If you select the radio button before **MAC Address of Root AP**, the AP client will connect to the AP according MAC address. Enter the MAC address of AP that you want to access.
- **Channel Width** - Determines the channel width to be used. It is unnecessary to change the default value unless required.
- **Enable Wireless Radio** - Select or deselect this check box to allow or deny wireless stations to access the device.

Click the **Survey** button to detect the SSIDs in the local area.

 **Note:**

To apply any settings you have altered on the page, please click the **Save** button, and then you will be reminded to reboot the device.

- 5) **Bridge with AP:** This mode can bridge the AP and up to 4 APs also in bridge mode to connect two or more wired LANs.

Figure 4-14 Wireless Settings in Bridge with AP mode

Wireless Bridge Setting

- **Wireless Name of Remote AP** - If you select the radio button before **Wireless Name of Remote AP**, the AP client will connect to the AP according to SSID. Enter the SSID of AP that you want to access.
- **MAC Address of Remote AP** - If you select the radio button before **MAC Address of Remote AP**, the AP client will connect to the AP according MAC address. Enter the MAC address of AP that you want to access.

Click the **Survey** button to detect the SSIDs in the local area.

- **Key type** - This option should be chosen according to the AP's security configuration. It is recommended that the security type is the same as your AP's security type.
- **Password** - If the Remote AP that your device is going to connect needs password, you need to fill the password in this blank.

Local Wireless AP Setting

- **Local Wireless Name** - Name for the AP.
- **Region** - Select your region from the pull-down list. This field specifies the region where the wireless function of the device can be used. It may be illegal to use the wireless function of

the device in a region other than one of those specified in this field. If your country or region is not listed, please contact your local government agency for assistance.

When you select your local region from the pull-down list, click the **Save** button, then the Note Dialog appears. Click **OK**.

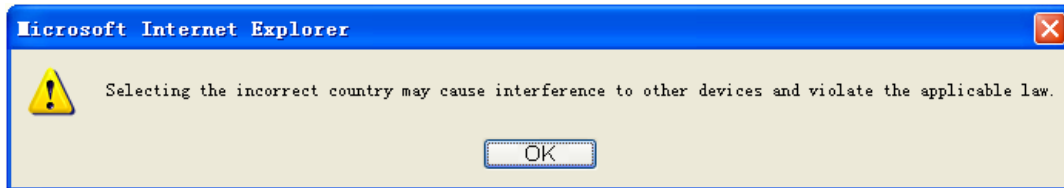

Note Dialog

Note:

Limited by local law regulations, version for North America does not have region selection option.

- **Channel** - Determines the operating frequency to be used. It is not necessary to change the wireless channel unless you notice interference problems with another nearby access point.
- **Mode** - This field determines the wireless mode which the device works on.
 - **11b only** - Only 802.11b wireless stations can connect to the device.
 - **11g only** - Only 802.11g wireless stations can connect to the device.
 - **11n only** - Only 802.11n wireless stations can connect to the device.
 - **11bg mixed** - Both 802.11b and 802.11g wireless stations can connect to the device.
 - **11bgn mixed** - All 802.11b, 802.11g and 802.11n wireless stations can connect to the device.
- **Channel Width** - Determines the channel width to be used. It is unnecessary to change the default value unless required.
- **Enable Wireless Radio** - Select or deselect this check box to allow or deny wireless stations to access the device.
- **Enable SSID Broadcast** - Select or deselect this check box to allow or deny the device to broadcast its name (SSID) on the air. If it's allowed, when wireless clients survey the local area for wireless networks to associate with, they will detect the SSID broadcast by the device.

Note:

To apply any settings you have altered on the page, please click the **Save** button, and then you will be reminded to reboot the device.

4.7.2 Wireless Security

Selecting **Wireless > Wireless Security** will enable you to configure wireless security for your wireless network to protect your data from intruders. The AP provides three security types: WEP, WPA/WPA2 and WPA-PSK/WPA2-PSK. Wireless security can be set on the following screen shown as Figure 4-15. The security options are different for different operation mode.

1) Access Point

Wireless Security

Disable Security

WPA/WPA2 - Personal(Recommended)

Version:

Encryption:

Password:
(You can enter ASCII characters between 8 and 63 or Hexadecimal characters between 8 and 64.)

Group Key Update Period: (in second, minimum is 30, 0 means no update)

WPA/WPA2 - Enterprise

Version:

Encryption:

Radius Server IP:

Radius Port: (1-65535, 0 stands for default port 1812)

Radius Password:

Group Key Update Period: (in second, minimum is 30, 0 means no update)

WEP

Type:

WEP Key Format:

Key Selected	WEP Key	Key Type
Key 1: <input checked="" type="radio"/>	<input type="text"/>	<input type="text" value="Disabled"/>
Key 2: <input type="radio"/>	<input type="text"/>	<input type="text" value="Disabled"/>
Key 3: <input type="radio"/>	<input type="text"/>	<input type="text" value="Disabled"/>
Key 4: <input type="radio"/>	<input type="text"/>	<input type="text" value="Disabled"/>

We do not recommend using the WEP encryption if the device operates in 802.11n mode due to the fact that WEP is not supported by 802.11n specification.

Figure 4-15 Wireless Security - Access Point

- **Disable Security** - Check this box radio button to disable wireless security. If disabled, the wireless stations will be able to connect this device without encryption. It is strongly recommended that you choose one of the security types to enable security.
- **WPA/WPA2-Personal(Recommended)** - Select WPA/WPA2 based on Radius Server.
 - **Version** - You can select one of following versions.
 - 1) **Automatic(Recommended)** - Select **WPA-Personal** or **WPA2-Personal** automatically based on the wireless station's capability and request.
 - 2) **WPA-Personal** - Wi-Fi Protected Access.
 - 3) **WPA2-Personal** - WPA version 2.
 - **Encryption** - You can select either **Automatic**, **TKIP** or **AES**.
 - **Radius Server IP** - Enter the IP address of the Radius Server.
 - **Radius Port** - Enter the port used by radius service.
 - **Radius Password** - Enter the password for the Radius Server.
 - **Group Key Update Period** - Specify the group key update interval in seconds. The value can be either 0 or at least 30. Enter 0 to disable the update.

- **WPA/WPA2-Enterprise** - Select WPA/WPA2 based on Radius Server.
 - **Version** - You can select one of following versions.
 - 1) **Automatic** - Select **WPA** or **WPA2** automatically based on the wireless station's capability and request.
 - 2) **WPA** - Wi-Fi Protected Access.
 - 3) **WPA2** - WPA version 2.
 - **Encryption** - You can select either **Automatic**, **TKIP** or **AES**.
 - **Radius Server IP** - Enter the IP address of the Radius Server.
 - **Radius Port** - Enter the port used by radius service.
 - **Radius Password** - Enter the password for the Radius Server.
 - **Group Key Update Period** - Specify the group key update interval in seconds. The value can be either 0 or at least 30. Enter 0 to disable the update.
- **WEP** - Select 802.11 WEP security.
 - **Type** - You can select one of following types.
 - 1) **Automatic** - Select **Shared Key** or **Open System** authentication type automatically based on the wireless station's capability and request.
 - 2) **Shared Key** - Select 802.11 **Shared Key** authentication type.
 - 3) **Open System** - Select 802.11 **Open System** authentication.
 - **WEP Key Format** - You can select **ASCII** or **Hexadecimal** format. ASCII format stands for any combination of keyboard characters in the specified length. Hexadecimal format stands for any combination of hexadecimal digits (0-9, a-f, A-F) in the specified length.
 - **WEP Key** - Select which of the four keys will be used and enter the matching WEP key information for your network in the selected key radio button. These values must be identical on all wireless stations in your network.
 - **Key Type** - You can select the WEP key length (**64-bit**, or **128-bit**, or **152-bit**.) for encryption. "Disabled" means this WEP key entry is invalid.
 - 1) For **64-bit** encryption - You can enter 10 hexadecimal digits (any combination of 0-9, a-f, A-F, zero key is not permitted) or 5 ASCII characters.
 - 2) For **128-bit** encryption - You can enter 26 hexadecimal digits (any combination of 0-9, a-f, A-F, zero key is not permitted) or 13 ASCII characters.
 - 3) For **152-bit** encryption - You can enter 32 hexadecimal digits (any combination of 0-9, a-f, A-F, zero key is not permitted) or 16 ASCII characters.

 **Note:**

1. If you do not set the key, the wireless security function is still disabled even if you have selected Shared Key as Authentication Type.
2. You will be reminded to reboot the device after clicking the **Save** button.

2) Multi-SSID

Wireless Security

Selected SSID: TP-LINK_67335F

Disable Security

WPA/WPA2 - Personal(Recommended)

Version: Automatic(Recommended)

Encryption: Automatic(Recommended)

Password: 1234567890
(You can enter ASCII characters between 8 and 63 or Hexadecimal characters between 8 and 64.)

Group Key Update Period: 0 (in second, minimum is 30, 0 means no update)

WPA/WPA2 - Enterprise

Version: Automatic

Encryption: Automatic

Radius Server IP:

Radius Port: 1812 (1-65535, 0 stands for default port 1812)

Radius Password:

Group Key Update Period: 0 (in second, minimum is 30, 0 means no update)

Save

Figure 4-16 Wireless Security – Multi-SSID

- **Disable Security** - Check this box radio button to disable wireless security. If disabled, the wireless stations will be able to connect this device without encryption. It is strongly recommended that you choose one of the security types to enable security.
- **WPA/WPA2-Personal(Recommended)** - Select WPA/WPA2 based on Radius Server.
 - **Version** - You can select one of following versions.
 - 1) **Automatic(Recommended)** - Select **WPA-Personal** or **WPA2-Personal** automatically based on the wireless station's capability and request.
 - 2) **WPA-Personal** - Wi-Fi Protected Access.
 - 3) **WPA2-Personal** - WPA version 2.
 - **Encryption** - You can select either **Automatic**, **TKIP** or **AES**.
 - **Radius Server IP** - Enter the IP address of the Radius Server.
 - **Radius Port** - Enter the port used by radius service.
 - **Radius Password** - Enter the password for the Radius Server.
 - **Group Key Update Period** - Specify the group key update interval in seconds. The value can be either 0 or at least 30. Enter 0 to disable the update.
- **WPA/WPA2-Enterprise** - Select WPA/WPA2 based on Radius Server.
 - **Version** - You can select one of following versions.
 - 1) **Automatic** - Select **WPA** or **WPA2** automatically based on the wireless station's capability and request.
 - 2) **WPA** - Wi-Fi Protected Access.

- 3) **WPA2** - WPA version 2.
 - **Encryption** - You can select either **Automatic**, **TKIP** or **AES**.
 - **Radius Server IP** - Enter the IP address of the Radius Server.
 - **Radius Port** - Enter the port used by radius service.
 - **Radius Password** - Enter the password for the Radius Server.

Group Key Update Period - Specify the group key update interval in seconds. The value can be either 0 or at least 30. Enter 0 to disable the update.

Note:

You will be reminded to reboot the device after clicking the **Save** button.

3) Client

Figure 4-17 Wireless Security – Client

- **Disable Security** - Check this box radio button to disable wireless security. If disabled, the wireless stations will be able to connect this device without encryption. It is strongly recommended that you choose one of the security types to enable security.
- **WPA/WPA2-Personal(Recommended)** - Select WPA/WPA2 based on Radius Server.
 - **Version** - You can select one of following versions.
 - 1) **Automatic(Recommended)** - Select **WPA-Personal** or **WPA2-Personal** automatically based on the wireless station's capability and request.
 - 2) **WPA-Personal** - Wi-Fi Protected Access.
 - 3) **WPA2-Personal** - WPA version 2.
 - **Encryption** - You can select either **Automatic**, **TKIP** or **AES**.

- **Radius Server IP** - Enter the IP address of the Radius Server.
 - **Radius Port** - Enter the port used by radius service.
 - **Radius Password** - Enter the password for the Radius Server.
 - **Group Key Update Period** - Specify the group key update interval in seconds. The value can be either 0 or at least 30. Enter 0 to disable the update.
- **WEP** - Select 802.11 WEP security.
- **Type** - You can select one of following types.
 - 1) **Automatic** - Select **Shared Key** or **Open System** authentication type automatically based on the wireless station's capability and request.
 - 2) **Shared Key** - Select 802.11 **Shared Key** authentication type.
 - 3) **Open System** - Select 802.11 **Open System** authentication.
 - **WEP Key Format** - You can select **ASCII** or **Hexadecimal** format. ASCII format stands for any combination of keyboard characters in the specified length. Hexadecimal format stands for any combination of hexadecimal digits (0-9, a-f, A-F) in the specified length.
 - **WEP Key** - Select which of the four keys will be used and enter the matching WEP key information for your network in the selected key radio button. These values must be identical on all wireless stations in your network.
 - **Key Type** - You can select the WEP key length (**64-bit**, or **128-bit**, or **152-bit**.) for encryption. "Disabled" means this WEP key entry is invalid.
 - 4) For **64-bit** encryption - You can enter 10 hexadecimal digits (any combination of 0-9, a-f, A-F, zero key is not permitted) or 5 ASCII characters.
 - 5) For **128-bit** encryption - You can enter 26 hexadecimal digits (any combination of 0-9, a-f, A-F, zero key is not permitted) or 13 ASCII characters.
 - 6) For **152-bit** encryption - You can enter 32 hexadecimal digits (any combination of 0-9, a-f, A-F, zero key is not permitted) or 16 ASCII characters.

 **Note:**

1. If you do not set the key, the wireless security function is still disabled even if you have selected Shared Key as Authentication Type.
2. You will be reminded to reboot the device after clicking the **Save** button.

4) Repeater (Range Extender)

Figure 4-18 Wireless Security – Repeater

- **Disable Security** - Check this box radio button to disable wireless security. If disabled, the wireless stations will be able to connect this device without encryption. It is strongly recommended that you choose one of the security types to enable security.
- **WPA/WPA2-Personal(Recommended)** - Select WPA/WPA2 based on Radius Server.
 - **Version** - You can select one of following versions.
 - 1) **Automatic(Recommended)** - Select **WPA-Personal** or **WPA2-Personal** automatically based on the wireless station's capability and request.
 - 2) **WPA-Personal** - Wi-Fi Protected Access.
 - 3) **WPA2-Personal** - WPA version 2.
 - **Encryption** - You can select either **Automatic**, **TKIP** or **AES**.
 - **Radius Server IP** - Enter the IP address of the Radius Server.
 - **Radius Port** - Enter the port used by radius service.
 - **Radius Password** - Enter the password for the Radius Server.
 - **Group Key Update Period** - Specify the group key update interval in seconds. The value can be either 0 or at least 30. Enter 0 to disable the update.
- **WEP** - Select 802.11 WEP security.
 - **Type** - You can select one of following types.
 - 1) **Automatic** - Select **Shared Key** or **Open System** authentication type automatically based on the wireless station's capability and request.
 - 2) **Shared Key** - Select 802.11 **Shared Key** authentication type.

- 3) **Open System** - Select 802.11 **Open System** authentication.
 - **WEP Key Format** - You can select **ASCII** or **Hexadecimal** format. ASCII format stands for any combination of keyboard characters in the specified length. Hexadecimal format stands for any combination of hexadecimal digits (0-9, a-f, A-F) in the specified length.
 - **WEP Key** - Select which of the four keys will be used and enter the matching WEP key information for your network in the selected key radio button. These values must be identical on all wireless stations in your network.
 - **Key Type** - You can select the WEP key length (**64-bit**, or **128-bit**, or **152-bit**.) for encryption. "Disabled" means this WEP key entry is invalid.
- 1) For **64-bit** encryption - You can enter 10 hexadecimal digits (any combination of 0-9, a-f, A-F, zero key is not permitted) or 5 ASCII characters.
- 2) For **128-bit** encryption - You can enter 26 hexadecimal digits (any combination of 0-9, a-f, A-F, zero key is not permitted) or 13 ASCII characters.
- 3) For **152-bit** encryption - You can enter 32 hexadecimal digits (any combination of 0-9, a-f, A-F, zero key is not permitted) or 16 ASCII characters.

 **Note:**

1. If you do not set the key, the wireless security function is still disabled even if you have selected Shared Key as Authentication Type.
2. You will be reminded to reboot the device after clicking the **Save** button.

5) Bridge with AP

Wireless Security

Disable Security

WPA/WPA2 - Personal(Recommended)

Version:

Encryption:

Password:
(You can enter ASCII characters between 8 and 63 or Hexadecimal characters between 8 and 64.)

Group Key Update Period: (in second, minimum is 30, 0 means no update)

WPA/WPA2 - Enterprise

Version:

Encryption:

Radius Server IP:

Radius Port: (1-65535, 0 stands for default port 1812)

Radius Password:

Group Key Update Period: (in second, minimum is 30, 0 means no update)

WEP

Type:

WEP Key Format:

Key Selected	WEP Key	Key Type
Key 1: <input checked="" type="radio"/>	<input type="text"/>	Disabled <input type="text"/>
Key 2: <input type="radio"/>	<input type="text"/>	Disabled <input type="text"/>
Key 3: <input type="radio"/>	<input type="text"/>	Disabled <input type="text"/>
Key 4: <input type="radio"/>	<input type="text"/>	Disabled <input type="text"/>

Figure 4-19 Wireless Security – Bridge with AP

- **Disable Security** - Check this box radio button to disable wireless security. If disabled, the wireless stations will be able to connect this device without encryption. It is strongly recommended that you choose one of the security types to enable security.
- **WPA/WPA2-Personal(Recommended)** - Select WPA/WPA2 based on Radius Server.
 - **Version** - You can select one of following versions.
 - 1) **Automatic(Recommended)** - Select **WPA-Personal** or **WPA2-Personal** automatically based on the wireless station's capability and request.
 - 2) **WPA-Personal** - Wi-Fi Protected Access.
 - 3) **WPA2-Personal** - WPA version 2.
 - **Encryption** - You can select either **Automatic**, **TKIP** or **AES**.
 - **Radius Server IP** - Enter the IP address of the Radius Server.
 - **Radius Port** - Enter the port used by radius service.
 - **Radius Password** - Enter the password for the Radius Server.
 - **Group Key Update Period** - Specify the group key update interval in seconds. The value can be either 0 or at least 30. Enter 0 to disable the update.

- **WPA/WPA2-Enterprise** - Select WPA/WPA2 based on Radius Server.
 - **Version** - You can select one of following versions.
 - 1) **Automatic** - Select **WPA** or **WPA2** automatically based on the wireless station's capability and request.
 - 2) **WPA** - Wi-Fi Protected Access.
 - 3) **WPA2** - WPA version 2.
 - **Encryption** - You can select either **Automatic**, **TKIP** or **AES**.
 - **Radius Server IP** - Enter the IP address of the Radius Server.
 - **Radius Port** - Enter the port used by radius service.
 - **Radius Password** - Enter the password for the Radius Server.
 - **Group Key Update Period** - Specify the group key update interval in seconds. The value can be either 0 or at least 30. Enter 0 to disable the update.
- **WEP** - Select 802.11 WEP security.
 - **Type** - You can select one of following types.
 - 1) **Automatic** - Select **Shared Key** or **Open System** authentication type automatically based on the wireless station's capability and request.
 - 2) **Shared Key** - Select 802.11 **Shared Key** authentication type.
 - 3) **Open System** - Select 802.11 **Open System** authentication.
 - **WEP Key Format** - You can select **ASCII** or **Hexadecimal** format. ASCII format stands for any combination of keyboard characters in the specified length. Hexadecimal format stands for any combination of hexadecimal digits (0-9, a-f, A-F) in the specified length.
 - **WEP Key** - Select which of the four keys will be used and enter the matching WEP key information for your network in the selected key radio button. These values must be identical on all wireless stations in your network.
 - **Key Type** - You can select the WEP key length (**64-bit**, or **128-bit**, or **152-bit**.) for encryption. "Disabled" means this WEP key entry is invalid.
 - 1) For **64-bit** encryption - You can enter 10 hexadecimal digits (any combination of 0-9, a-f, A-F, zero key is not permitted) or 5 ASCII characters.
 - 2) For **128-bit** encryption - You can enter 26 hexadecimal digits (any combination of 0-9, a-f, A-F, zero key is not permitted) or 13 ASCII characters.
 - 3) For **152-bit** encryption - You can enter 32 hexadecimal digits (any combination of 0-9, a-f, A-F, zero key is not permitted) or 16 ASCII characters.

 **Note:**

1. If you do not set the key, the wireless security function is still disabled even if you have selected Shared Key as Authentication Type.
2. You will be reminded to reboot the device after clicking the **Save** button.

4.7.3 Wireless MAC Filtering

Selecting **Wireless > Wireless MAC Filtering** will allow you to set up some filtering rules to

control wireless stations accessing the device, which depend on the station’s MAC address on the following screen as shown Figure 4-20. This function is not available when the operation is set to Client. As the configuration is the same in each operation mode, here we just take the Access Point for example.



Figure 4-20 Wireless MAC address Filtering

The Wireless MAC Address Filtering feature allows you to control wireless stations accessing the device, which depend on the station’s MAC addresses.

- **Wireless MAC Filtering** - Click the **Enable** button to enable the Wireless MAC Address Filtering. The default setting is disabled.

To Add a Wireless MAC Address filtering entry, click the **Add New...** button. The “Add or Modify Wireless MAC Address Filtering entry” page will appear, shown in Figure 4-21

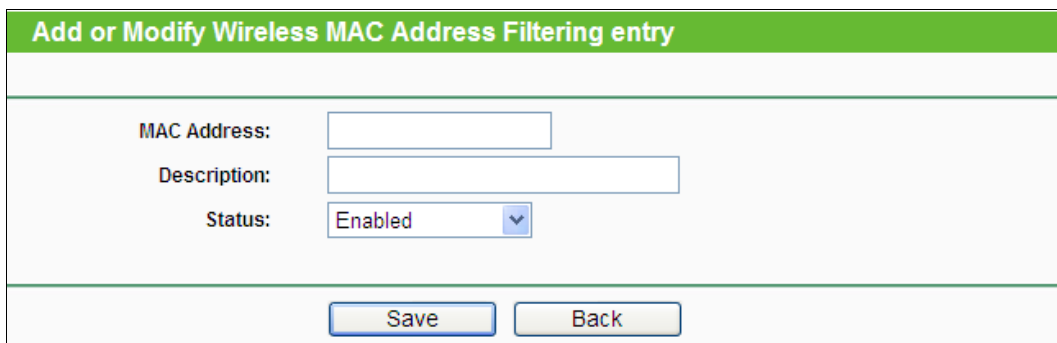

Figure 4-21 Add or Modify Wireless MAC Address Filtering entry

- **MAC Address** - Enter the wireless station's MAC address that you want to control.
- **Description** - Give a simple description of the wireless station.
- **Status** - Select a status for this entry, either **Enabled** or **Disabled**.

To set up an entry, follow these instructions:

First, you must decide whether the unspecified wireless stations can access the device or not. If you desire that the unspecified wireless stations can access the device, please select the radio

button **Deny the stations specified by any enabled entries in the list to access**, otherwise, select the radio button **Allow the stations specified by any enabled entries in the list to access**.

To add a MAC Address Filtering entry, follow these instructions:

1. Enter the appropriate MAC Address into the **MAC Address** field. The format of the MAC Address is XX-XX-XX-XX-XX-XX (X is any hexadecimal digit). For example: 00-0A-EB-B0-00-0B.
2. Enter a simple description of the wireless station in the **Description** field. For example: Wireless station A.
3. Select **Enabled** or **Disabled** for this entry on the **Status** pull-down list.
4. Click the **Save** button to save this entry.

To add additional entries, repeat steps 1-4.

To modify or delete an existing entry:

1. Click the **Modify** in the entry you want to modify. If you want to delete the entry, click the **Delete**.
2. Modify the information.
3. Click the **Save** button.

Click the **Enable All** button to make all entries enabled

Click the **Disabled All** button to make all entries disabled.

Click the **Delete All** button to delete all entries

Click the **Next** button to go to the next page and click the **Previous** button to return to the previous page.

For example: If you desire that the wireless station A with MAC address 00-0A-EB-00-07-BE is able to access the device, while all other wireless stations cannot access the device, you should configure the **Wireless MAC Address Filtering** list by following these steps:

1. Click the **Enable** button to enable this function.
2. Select the radio button: **Allow the stations specified by any enabled entries in the list to access** for **Filtering Rules**.
3. Delete all or disable all entries if there are any entries already.
4. Click the **Add New...** button and enter the MAC address 00-0A-EB-00-07-BE in the **MAC Address** field, enter Wireless Station A in the **Description** field and select **Enabled** in the **Status** pull-down list. Click the **Save** button.

The filtering rules that configured should be similar to the following list:

ID	MAC Address	Status	Description	Modify
1	00-0A-EB-00-07-BE	Enabled	wireless station A	Modify Delete

Note:

If you enable the function and select the “**Allow the stations specified by any enabled entries in the list to access**” for **Filtering Rules**, and there are not any enabled entries in the list, thus, no wireless stations can access the device.

4.7.4 Wireless Advanced

Selecting **Wireless > Wireless Advanced** will allow you to do some advanced settings for the device in the following screen shown in Figure 4-22. As the configuration for each operation mode is almost the same, we take Access Point mode for example here.

Wireless Advanced		
Beacon Interval :	<input type="text" value="100"/>	(40-1000)
RTS Threshold:	<input type="text" value="2346"/>	(256-2346)
Fragmentation Threshold:	<input type="text" value="2346"/>	(256-2346)
DTIM Interval:	<input type="text" value="1"/>	(1-255)
	<input checked="" type="checkbox"/>	Enable WMM
	<input checked="" type="checkbox"/>	Enable Short GI
	<input type="checkbox"/>	Enable AP Isolation
<input type="button" value="Save"/>		

Figure 4-22 Wireless Advanced

- **Beacon Interval** - Specifies a value between 20-1000 milliseconds. The beacons are the packets sent by the device to synchronize a wireless network. Beacon Interval value determines the time interval of the beacons. The default value is 100.
- **RTS Threshold** - Specifies the RTS (Request to Send) Threshold. If the packet is larger than the specified RTS Threshold size, the device will send RTS frames to a particular receiving station and negotiate the sending of a data frame. The default value is 2346.
- **Fragmentation Threshold** - This value is the maximum size determining whether packets will be fragmented. Setting the Fragmentation Threshold too low may result in poor network performance since excessive packets. 2346 is the default setting and is recommended.
- **DTIM Interval** - Determines the interval of the Delivery Traffic Indication Message (DTIM). You can specify the value between 1-255 Beacon Intervals. The default value is 1, which indicates the DTIM Interval is the same as Beacon Interval.
- **Enable WMM** - WMM function can guarantee the packets with high- priority messages being transmitted preferentially. It is strongly recommended enabled.
- **Enable Short GI** - This function is recommended for it will increase the data capacity by reducing the guard interval time.
- **Enable AP Isolation** - Isolates all connected wireless stations so that wireless stations cannot access each other through WLAN. This function will be disabled if WDS/Bridge is enabled.

4.7.5 Antenna Alignment

Selecting **Wireless > Antenna Alignment** will show how remote AP's signal strength changes while changing the antenna's direction in the following screen shown in Figure 4-23.

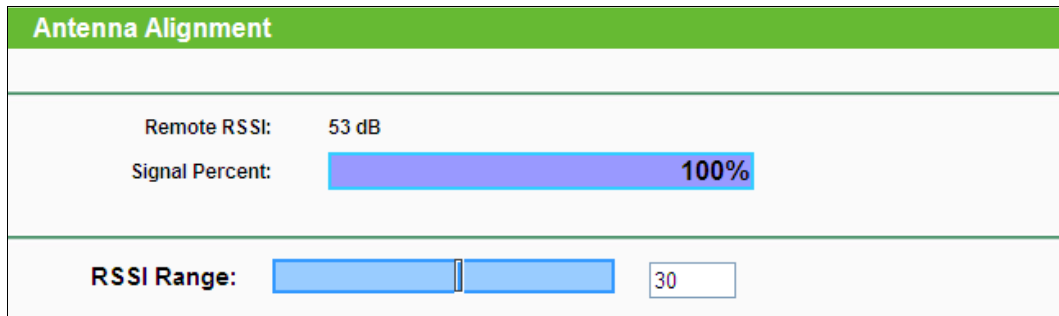

Figure 4-23 Antenna Alignment

- **Remote RSSI** - Remote AP's signal strength value.
- **Signal Percent** - The ratio of RSSI to RSSI RANGE in percentage.
- **RSSI Range** - Drag the Slider to set or input the RSSI RANGE value.

4.7.6 Throughput Monitor

Selecting **Wireless > Throughput Monitor** will help to watch wireless throughput information in the following screen shown in Figure 4-24.

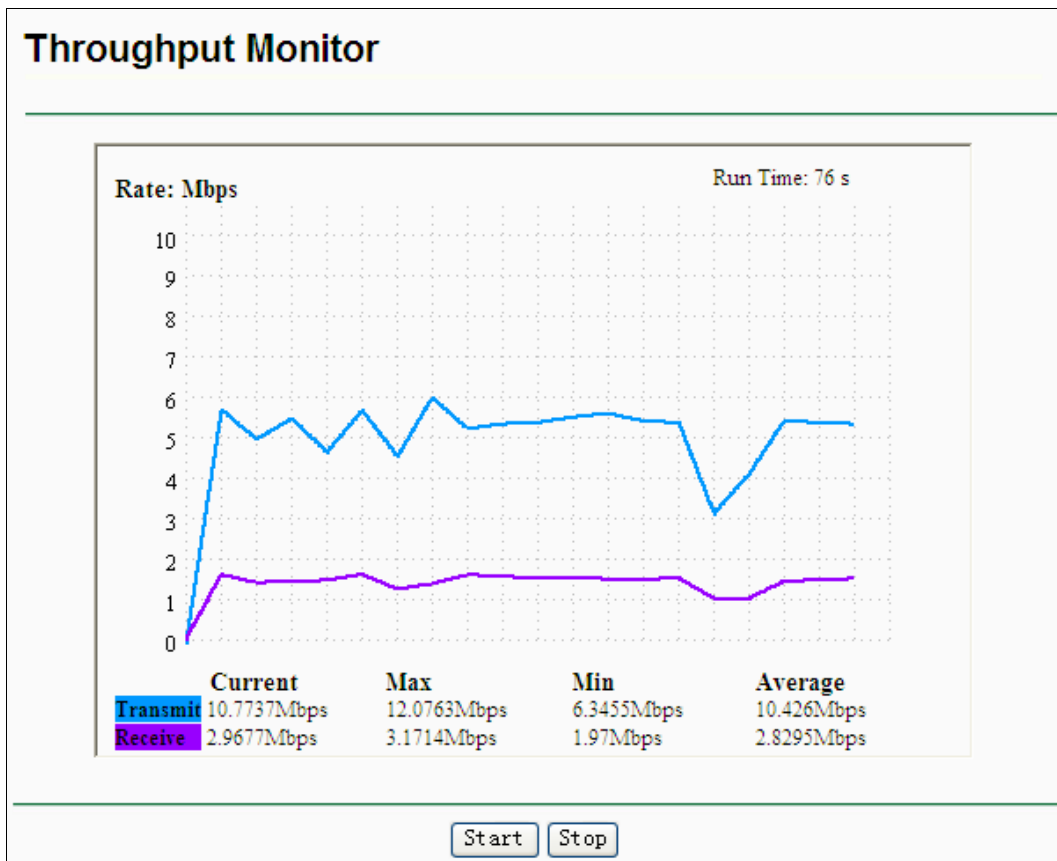

Figure 4-24 Throughput Monitor

- **Rate** - The Throughput unit.

- **Run Time** - How long this function is running.
- **Transmit** - Wireless transmit rate information.
- **Receive** - Wireless receive rate information.

Click the **Start** button to start wireless throughput monitor.

Click the **Stop** button to stop wireless throughput monitor.

4.7.7 Wireless Statistics

Selecting **Wireless > Wireless Statistics** will allow you to see the wireless transmission information in the following screen shown in Figure 4-25.

Wireless Statistics				
Current Connected Wireless Stations numbers: 2 <input type="button" value="Refresh"/>				
ID	MAC Address	Current Status	Received Packets	Sent Packets
1	88-C6-63-39-2E-38	WPA2-Personal	137	66
2	00-90-A2-5B-6F-96	WPA2-Personal	7	2
<input type="button" value="Previous"/> <input type="button" value="Next"/>				

Figure 4-25 Statistics of the device attached wireless stations

- **MAC Address** - Shows the connected wireless station's MAC address
- **Current Status** - The connected wireless station's running status, one of STA-AUTH / STA-ASSOC / STA-JOINED / WPA / WPA-PSK / WPA2 / WPA2-PSK / AP-UP / AP-DOWN / Disconnected
- **Received Packets** - packets received by the station
- **Sent Packets** - packets sent by the station

You cannot change any of the values on this page. To update this page and to show the current connected wireless stations, click the **Refresh** button.

If the numbers of connected wireless stations go beyond one page, click the **Next** button to go to the next page and click the **Previous** button to return the previous page.

Note:

This page will be refreshed automatically every 5 seconds.

4.8 DHCP

DHCP stands for Dynamic Host Configuration Protocol. The DHCP Server will automatically assign dynamic IP addresses to the computers on the network. This protocol simplifies network management and allows new wireless devices to receive IP addresses automatically without the need to manually assign new IP addresses.

There are three submenus under the DHCP menu (shown as Figure 4-26): **DHCP Settings**, **DHCP Clients List** and **Address Reservation**. Clicking any of them will enable you to configure

the corresponding function. The detailed explanations for each submenu are provided below.

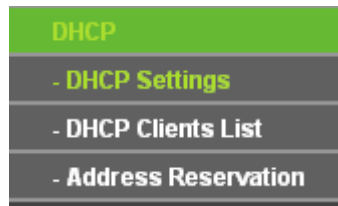

Figure 4-26 The DHCP menu

4.8.1 DHCP Settings

Selecting **DHCP > DHCP Settings** will enable you to set up the AP as a DHCP (Dynamic Host Configuration Protocol) server, which provides the TCP/IP configuration for all the PCs that are connected to the system on the LAN. The DHCP Server can be configured on the page (shown as Figure 4-27):

 A screenshot of the 'DHCP Settings' configuration page. The page has a green header with the text 'DHCP Settings'. Below the header, there are several configuration fields:

- DHCP Server:** Two radio buttons, 'Disable' (selected) and 'Enable'.
- Start IP Address:** A text box containing '192.168.0.100'.
- End IP Address:** A text box containing '192.168.0.199'.
- Address Lease Time:** A text box containing '120' followed by the text 'minutes (1~2880 minutes, the default value is 120)'.
- Default Gateway:** A text box containing '0.0.0.0' followed by '(optional)'.
- Default Domain:** A text box followed by '(optional)'.
- Primary DNS:** A text box containing '0.0.0.0' followed by '(optional)'.
- Secondary DNS:** A text box containing '0.0.0.0' followed by '(optional)'.

 At the bottom of the form is a 'Save' button.

Figure 4-27 DHCP Settings

- **DHCP Server** - Selecting the radio button before **Disable/Enable** will disable/enable the DHCP server on your AP. The default setting is **Enable**. If you disable the Server, you must have another DHCP server within your network or else you must manually configure the computer.
- **Start IP Address** - This field specifies the first address in the IP Address pool. 192.168.0.100 is the default start IP address.
- **End IP Address** - This field specifies the last address in the IP Address pool. 192.168.0.199 is the default end IP address.
- **Address Lease Time** - Enter the amount of time for the PC to connect to the AP with its current assigned dynamic IP address. The time is measured in minutes. After the time is up, the PC will be automatically assigned a new dynamic IP address. The range of the time is 1 ~ 2880 minutes. The default value is 120 minutes.
- **Default Gateway (optional)** - Enter the IP address of the gateway for your LAN. The factory default setting is 0.0.0.0.
- **Default Domain (optional)** - Enter the domain name of the your DHCP server. You can leave the field blank.

- **Primary DNS (optional)** - Enter the DNS IP address provided by your ISP. Consult your ISP if you don't know the DNS value. The factory default setting is 0.0.0.0.
- **Secondary DNS (optional)** - Enter the IP address of another DNS server if your ISP provides two DNS servers. The factory default setting is 0.0.0.0.

Click **Save** to save the changes.

 **Note:**

1. When the device is working on Dynamic IP mode, the DHCP Server function will be disabled.
2. To use the DHCP server function of the device, you should configure all computers in the LAN as "Obtain an IP Address automatically" mode. This function will not take effect until the device reboots.

4.8.2 DHCP Clients List

Selecting **DHCP > DHCP Clients List** will enable you to view the Client Name, MAC Address, Assigned IP and Lease Time for each DHCP Client attached to the device (Figure 4-28).

DHCP Clients List				
ID	Client Name	MAC Address	Assigned IP	Lease Time
1	peipei	18-E7-F4-02-C9-73	192.168.0.101	01:58:27
2	android_80c03463cfc55608	00-90-A2-5B-6F-96	192.168.0.102	01:59:02

Figure 4-28 DHCP Clients List

- **ID** - Here displays the index of the DHCP client.
- **Client Name** - Here displays the name of the DHCP client.
- **MAC Address** - Here displays the MAC address of the DHCP client.
- **Assigned IP** - Here displays the IP address that the AP has allocated to the DHCP client.
- **Lease Time** - Here displays the time of the DHCP client leased. Before the time is up, DHCP client will request to renew the lease automatically.

You cannot change any of the values on this page. To update this page and to show the current attached devices, click on the **Refresh** button.

4.8.3 Address Reservation

Selecting **DHCP > Address Reservation** will enable you to specify a reserved IP address for a PC on the LAN, so the PC will always obtain the same IP address each time when it accesses the AP. Reserved IP addresses should be assigned to servers that require permanent IP settings. The screen below is used for address reservation (shown in Figure 4-29).

Address Reservation				
ID	MAC Address	Reserved IP Address	Status	Modify
1	00-0A-EB-00-07-5F	192.168.0.101	Enabled	Modify Delete

Figure 4-29 Address Reservation

- **MAC Address** - Here displays the MAC address of the PC for which you want to reserve an IP address.
- **Reserved IP Address** - Here displays the IP address that the AP is reserved.
- **Status** - Here shows whether the entry is enabled or not
- **Modify** - To modify or delete an existing entry.

To Reserve IP addresses:

1. Click the **Add New...** button to add a new Address Reservation entry.
2. Enter the MAC address in XX-XX-XX-XX-XX-XX format and IP address in dotted-decimal notation of the computer you wish to add.
3. Click **Save** when finished.

To modify A Reserved IP address:

1. Select the reserved address entry to your needs and click **Modify**. If you wish to delete the entry, click **Delete**.
2. Click **Save** to keep your changes.

To delete all Reserved IP addresses:

1. Click **Clear All**.
2. Click **Next** to go to the next page and Click **Previous** to return the previous page.

Note:

The changes won't take effect until the device reboots.

4.9 System Tools

System Tools option helps you to optimize the configuration of your device. SNMP can help you to manage the device locally or remotely with specified software. The diagnostic tools (Ping and Traceroute) allow you to check the connections of your network components. You can upgrade the AP to the latest version of firmware as well as backup or restore the AP's configuration files. Ping Watch Dog can help to continuously monitor a particular connection to a remote host. It's suggested that you change the default password to a more secure one because it controls access to the device's web-based management page. Besides, you can find out what happened to the system in System Log.

There are nine submenus under the **System Tools** menu (shown as Figure 4-30): **Time Settings**, **Diagnostic**, **Ping Watch Dog**, **Firmware Upgrade**, **Factory Defaults**, **Backup & Restore**, **Reboot**, **Password**, **System Log** and **Statistics**. Clicking any of them will enable you to configure the corresponding function. The detailed explanations for each submenu are provided below.

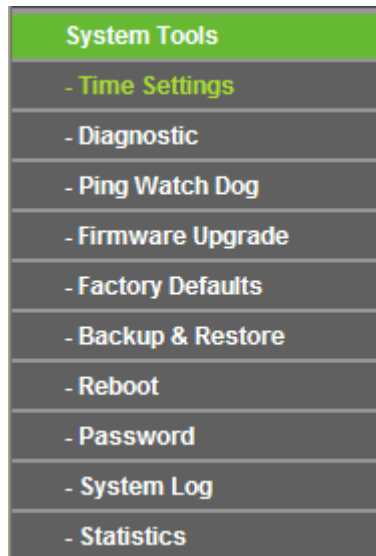

Figure 4-30 The System Tools menu

4.9.1 Time Settings

Choose menu "**System Tools > Time Settings**", and then you can configure the time on the following screen.

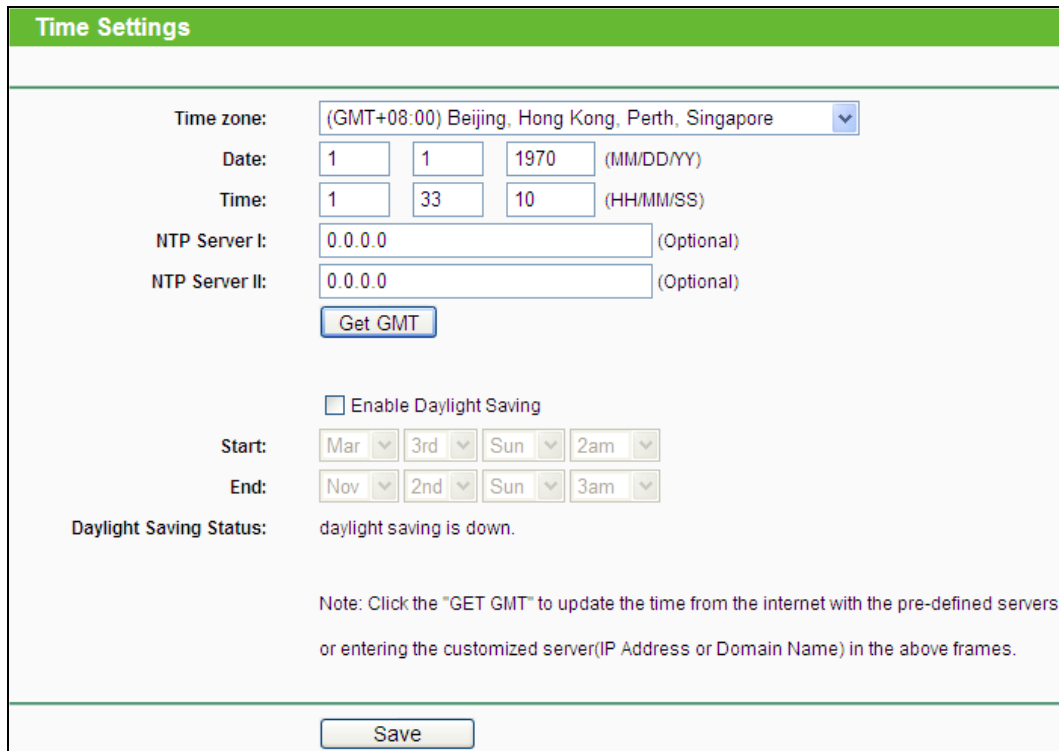

Figure 4-31 Time settings

- **Time Zone** - Select your local time zone from this pull down list.
- **To set time manually:**

1. Select your local time zone.
2. Enter the **Date** in Month/Day/Year format.
3. Enter the **Time** in Hour/Minute/Second format.
4. Click **Save**.

➤ **For automatic time synchronization:**

1. Enter the address of the **NTP Server Prior**.
2. Click the **Get GMT** button to get GMT from the Internet.

 **Note:**

1. This setting will be used for some time-based functions such as firewall functions. These time-dependant functions will not work if time is not set. So, it is important to specify time settings as soon as you successfully login to the Device.
2. The time will be lost if the Device is turned off.
3. The Device will automatically obtain GMT from the Internet if it is configured accordingly.

4.9.2 Diagnostic

Selecting **System Tools > Diagnostic** allow you to check the connections of your network components on the screen shown in Figure 4-32.

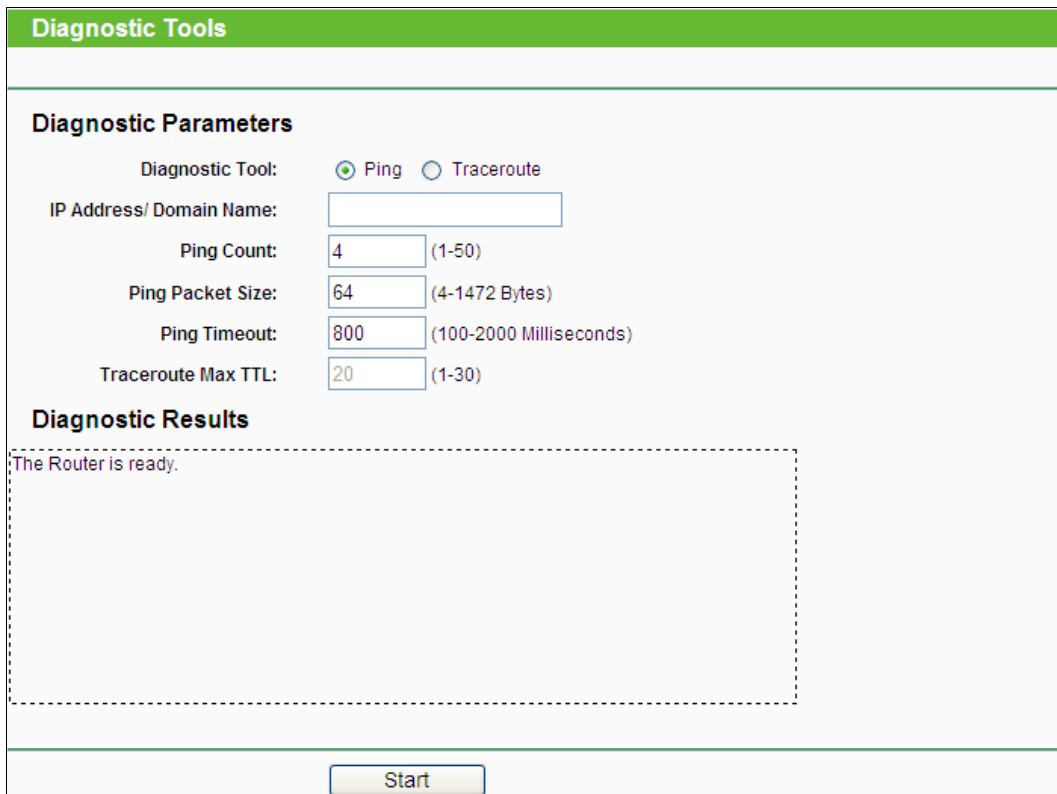

Diagnostic Tools

Diagnostic Parameters

Diagnostic Tool: Ping Traceroute

IP Address/ Domain Name:

Ping Count: (1-50)

Ping Packet Size: (4-1472 Bytes)

Ping Timeout: (100-2000 Milliseconds)

Traceroute Max TTL: (1-30)

Diagnostic Results

The Router is ready.

Figure 4-32 Diagnostic

Diagnostic Tools - Click the radio button to select one diagnostic tool

- **Ping** - This diagnostic tool troubleshoots connectivity, reachability, and name resolution to a given host or gateway by using the Internet Control Message Protocol (ICMP) protocol's mandatory Echo Request datagram to elicit an ICMP Echo Response from a

host or gateway. You can use ping to test both numeric IP address or domain name. If pinging the IP address is successful, but pinging the domain name is not, you might have a name resolution problem. In this case, ensure that the domain name you are specifying can be resolved by using Domain Name System (DNS) queries.

- Traceroute** - This diagnostic tool determines the path taken to a given host by sending Internet Control Message Protocol (ICMP) Echo Request messages with varying Time to Live (TTL) values to the destination. Each gateway along the path is required to decrement the TTL in an IP packet by at least 1 before forwarding it. Effectively, the TTL is a maximum link counter. When the TTL on a packet reaches 0, the gateway is expected to return an ICMP Time Exceeded response to your device. Traceroute determines the path by sending the first Echo Request message with a TTL of 1 and incrementing the TTL by 1 on each subsequent transmission until the target responds or the maximum number of hops is reached. The maximum number of hops is 20 by default and can be specified in the field "Traceroute Max TTL". The path is determined by examining the ICMP Time Exceeded messages returned by intermediate gateways and the Echo Reply message returned by the destination. However, some gateways do not return Time Exceeded messages for packets with expired TTL values and are invisible to the traceroute tool. In this case, a row of asterisks (*) is displayed for that hop.

IP Address - Enter the IP Address (such as 202.108.22.5) of the PC whose connection you wish to diagnose.

Ping Count - Specifies the number of Echo Request messages sent. The default is 4.

Ping Packet Size - Specifies the number of data bytes to be sent. The default is 64.

Ping Timeout - Specifies the time to wait for a response in milliseconds. The default is 800.

Traceroute Max TTL - Set the maximum number of hops (max TTL to be reached) in the path to Survey for the target (destination). The default is 20.

Click the **Start** button to start the diagnostic procedure.

The **Diagnostic Results** page displays the result of diagnosis.

If the result is similar to the following screen, the connectivity of the Internet is fine.

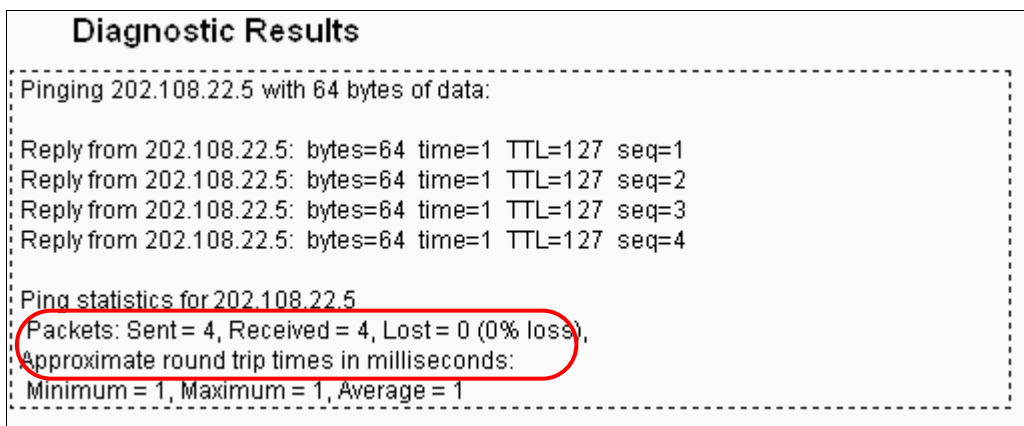

Figure 4-33 Diagnostic Results

Note:

- Only one user can use this tool at one time.
- Options "Number of Pings", "Ping Size" and "Ping Timeout" are only available for Ping function. Option "Tracert Hops" is available only for Tracert function.

4.9.3 Ping Watch Dog

Selecting **System Tools > Ping Watch Dog** allows you to continuously monitor the particular connection between the device to a remote host. It makes this device continuously ping a user defined IP address (it can be the internet gateway for example). If it is unable to ping under the user defined constraints, this device will automatically reboot.

Figure 4-34 Ping Watch Dog Utility

- **Enable** - Turn on/off Ping Watch Dog.
- **IP Address** - The IP address of the target host where the Ping Watch Dog Utility is sending ping packets.
- **Interval** - Time interval between two ping packets which are sent out continuously.
- **Delay** - Time delay before first ping packet is sent out when the device is restarted.
- **Fail Count** - Upper limit of the ping packet the device can drop continuously. If this value is overrun, the device will restart automatically.

Be sure to click the **Submit** button to make your settings in operation.

4.9.4 Firmware Upgrade

Selecting **System Tools > Firmware Upgrade** allows you to upgrade the latest version of firmware for the device on the screen shown in Figure 4-35.

Figure 4-35 Firmware Upgrade

New firmware versions are posted at <http://www.tp-link.com> and can be downloaded for free.

- **Firmware Version** - Here displays the current firmware version.
- **Hardware Version** - Here displays the current hardware version. The hardware version of the upgrade file must accord with the current hardware version.

Note:

1. There is no need to upgrade the firmware unless the new firmware has a new feature you want to use. However, when experiencing problems caused by the device itself, you can try to upgrade the firmware.
2. Before upgrading the device's firmware, you should write down some of your customized settings to avoid losing important configuration settings of device.

To upgrade the device's firmware, follow these instructions:

1. Download a more recent firmware upgrade file from the TP-LINK website (<http://www.tp-link.com>).
2. Enter the path name or click **Browse...** to select the downloaded file on the computer into the **File** blank.
3. Click **Upgrade**.

Note:

Do not turn off the device or press the **Reset** button while the firmware is being upgraded. The device will reboot after the Upgrading has been finished.

4.9.5 Factory Defaults

Selecting **System Tools > Factory Default** allows you to restore the factory default settings for the device on the screen shown in Figure 4-36.

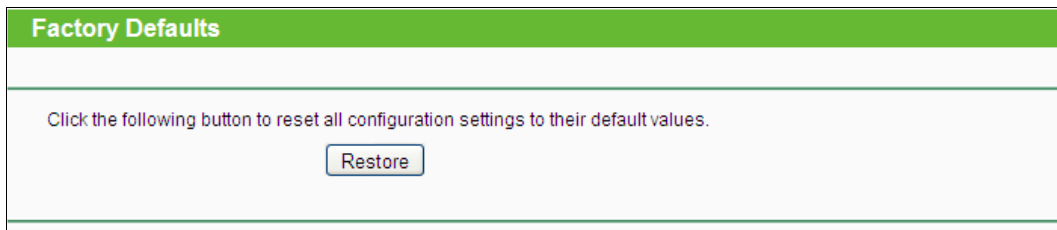

Figure 4-36 Restore Factory Defaults

Click **Restore** to reset all configuration settings to their default values.

- Default **User Name**: admin
- Default **Password**: admin
- Default **IP Address**: 192.168.0.254
- Default **Subnet Mask**: 255.255.255.0

Note:

Any settings you have saved will be lost when the default settings are restored.

4.9.6 Backup & Restore

Selecting **System Tools > Backup & Restore** allows you to save all configuration settings to your local computer as a file or restore the device's configuration on the screen shown in Figure 4-37.

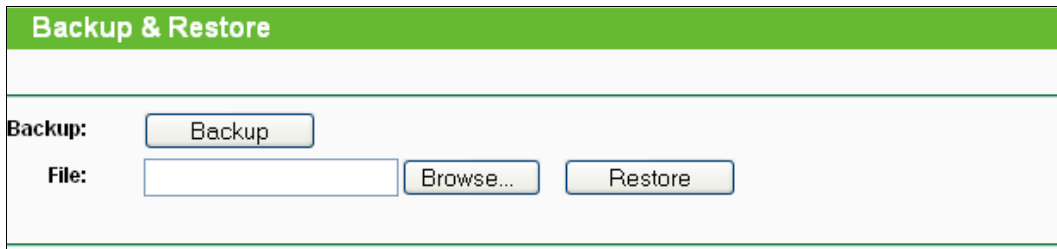

Figure 4-37 Save or Restore the Configuration

Click **Backup** to save all configuration settings to your local computer as a file.

To restore the device's configuration, follow these instructions:

- Click **Browse...** to find the configuration file which you want to restore.
- Click **Restore** to update the configuration with the file whose path is the one you have input or selected in the blank.

Note:

1. The current configuration will be covered with the uploading configuration file.
2. Wrong process will lead the device unmanaged.
3. The restoring process lasts for 20 seconds and restart automatically. Do not power off the device during the process to avoid any damage.

4.9.7 Reboot

Selecting **System Tools > Reboot** allows you to reboot the device on the screen shown in Figure 4-38.

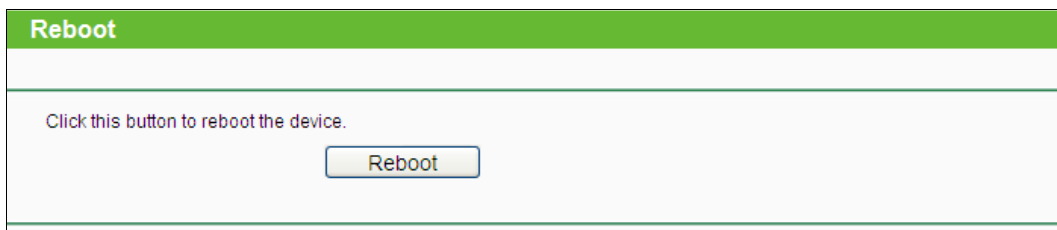

Figure 4-38 Reboot the device

Click the **Reboot** button to reboot the device.

Some settings of the device will take effect only after rebooting, which include:

- Change LAN IP Address (System will reboot automatically).
- Change the Wireless configurations.
- Change the Web Management Port.
- Upgrade the firmware of the device (system will reboot automatically).
- Restore the device's settings to factory defaults (system will reboot automatically).
- Update the configuration with a file (system will reboot automatically).

4.9.8 Password

Selecting **System Tools** > **Password** allows you to change the factory default user name and password of the device on the screen shown in Figure 4-39.

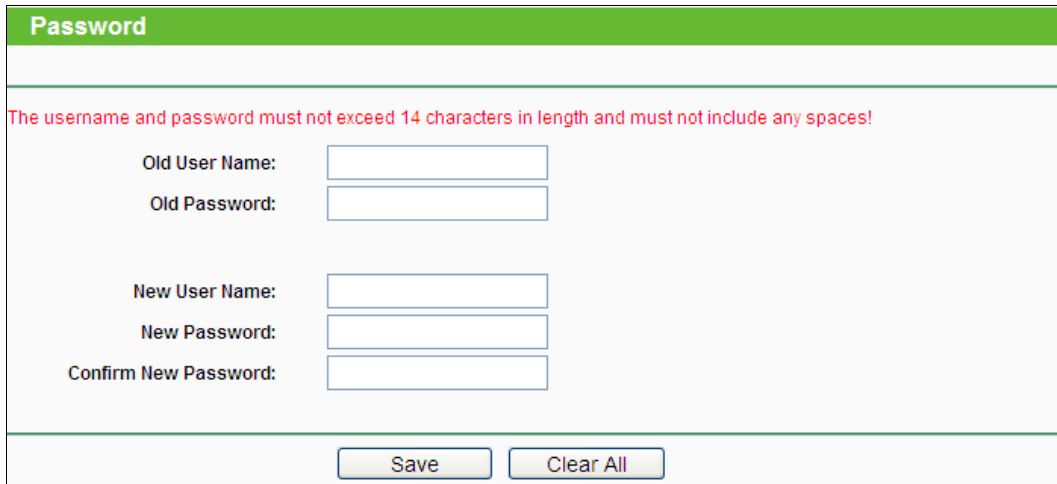

Password

The username and password must not exceed 14 characters in length and must not include any spaces!

Old User Name:

Old Password:

New User Name:

New Password:

Confirm New Password:

Figure 4-39 Password

It is strongly recommended that you change the factory default user name and password of the device. All users who try to access the device's web-based management page or Quick Setup will be prompted for the device's user name and password.

Note:

The new user name and password must not exceed 14 characters in length and must not include any spaces. Enter the new Password twice to confirm it.

Click **Save** when finished.

Click **Clear All** to clear all.

4.9.9 System Log

Selecting **System Tools** > **System Log** allows you to query the Logs of the device on the screen shown in Figure 4-40.

The screenshot shows the 'System Log' interface. At the top, there is a green header with the text 'System Log'. Below the header, there are two dropdown menus: 'Log Type: All' and 'Log Level: ALL'. A table with the following columns is displayed: 'Index', 'Time', 'Type', 'Level', and 'Log Content'. The table contains one row with the following data: Index: 1, Time: 1st day 01:40:11, Type: OTHER, Level: INFO, Log Content: User clear system log. Below the table, there is a text area containing system information: 'Time = 1970-01-01 1:40:10 6011s', 'H-Ver = WA701ND v2 00000000 : S-Ver = 3.12.11 Build 120409 Rel.31574n', 'L = 192.168.0.254 : M = 255.255.255.0', and 'W1 = DHCP : W = 0.0.0.0 : M = 0.0.0.0 : G = 0.0.0.0'. At the bottom of the interface, there are three buttons: 'Refresh', 'Save Log', and 'Clear Log'. At the very bottom, there are navigation buttons: 'Previous', 'Next', 'Current No. 1', and 'Page'.

Figure 4-40 System Log

The device can keep logs of all traffic. You can query the logs to find what happened to the device.

- **Log Type** - By selecting the log type, only logs of this type will be shown.
- **Log Level** - By selecting the log level, only logs of this level will be shown.

Click the **Refresh** button to show the latest log list..

Click the **Save Log** button to save all the logs in a txt file.

Click the **Clear Log** button to delete all the logs from the system permanently, not just from the page.

Click the **Next** button to go to the next page, or click the **Previous** button return to the previous page.

4.9.10 Statistics

Choose menu “**System Tools > Statistics**”, and then you can view the statistics of the Device, including total traffic and current traffic of the last Packets Statistic Interval.

Figure 4-41 Statistics

The Statistics page shows the network traffic of each PC on the LAN, including total traffic and the value of the last **Packets Statistic interval** in seconds.

- **Current Statistics Status** - Enabled or Disabled. The default value is disabled. To enable, click the Enable button. If disabled, the function of DoS protection in Security settings will be disabled.
- **Packets Statistics Interval** - The default value is 10. Select a value between 5 and 60 seconds in the pull-down list. The Packets Statistic interval value indicates the time section of the packets statistic.
- **Sorted Rules** - Choose how displayed statistics are sorted.

Click the **Auto-refresh** checkbox to refresh automatically.

Click the **Refresh** button to refresh the page.

Click the **Reset All** button to reset the values of all entries to zero.

Click the **Delete All** button to delete all entries in the table.

➤ **Statistics Table**

IP Address/ MAC Address	Total		Current				Modify
	Packets	Bytes	Packets	Bytes	ICMP Tx	UDP Tx	
The current list is empty.							

Figure 4-42 Statistics Table

- **IP Address/MAC Address** - The IP Address and MAC address are displayed with related statistics.
- **Total**
 - **Packets** - The total number of packets received and transmitted by the Device.
 - **Bytes** - The total number of bytes received and transmitted by the Device.
- **Current**

- **Packets** - The total number of packets received and transmitted in the last Packets Statistics interval seconds.
- **Bytes** - The total number of bytes received and transmitted in the last Packets Statistics interval seconds.
- **ICMP Tx** - The number of ICMP packets transmitted to the WAN per second at the specified Packets Statistics interval. It is shown like "current transmitting rate / Max transmitting rate".
- **UDP Tx** - The number of UDP packets transmitted to the WAN per second at the specified Packets Statistics interval. It is shown like "current transmitting rate / Max transmitting rate".
- **TCP SYN Tx** - The number of TCP SYN packets transmitted to the WAN per second at the specified Packets Statistics interval. It is shown like "current transmitting rate / Max transmitting rate".
 - **Modify**
- **Reset** - Reset the values of the entry to zero.

Delete - Delete the existing entry in the table.

Appendix A: Application Example

The TL-WA701ND allows you to connect a wireless device to the wired network. Providing that you want to connect your computer equipped with wireless adapter to a wired network wirelessly, you can take the following instructions.

1. Configure the AP via a wired connection.
 - 1) Connect your AP to your PC with an Ethernet cable.
 - 2) Log on to the web-based management page. Configure your AP in the **Access Point** mode and check the **Enable SSID Broadcast** box referring to [4.7.1 Wireless Settings](#).
 - 3) View the **Wireless > Wireless Settings** page and keep the SSID of the AP in mind. (Here we choose TP-LINK as the SSID for example.) You are suggested to change the SSID and secure your wireless network referring to [4.7.1 Wireless Settings](#) and [4.7.2 Wireless Security](#).
 - 4) Remove the Ethernet cable between the AP and your PC.
2. Connect your AP to the LAN port on the Router with an Ethernet cable.

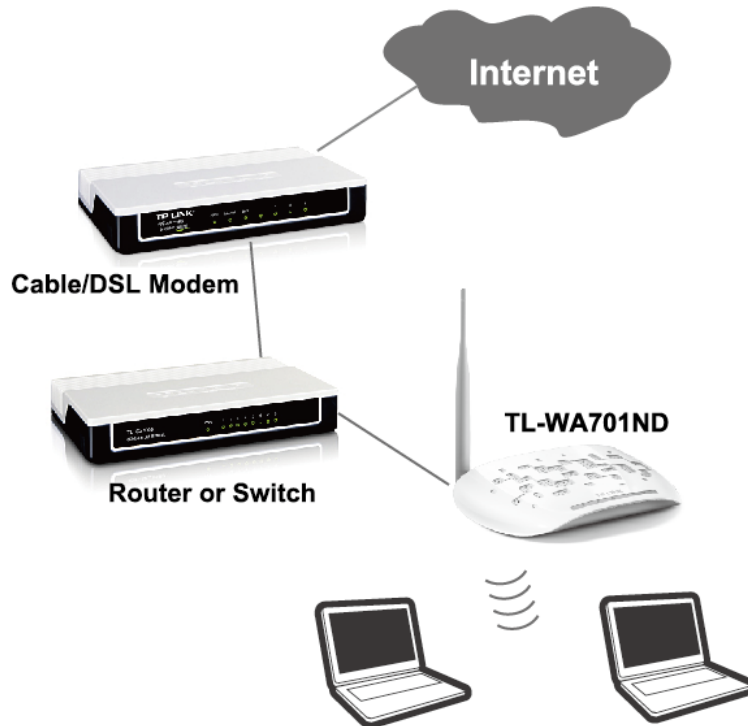

3. Configure your PC to connect to the network wirelessly.
 - 1) Click **start** (in the lower left corner of the PC's screen), right-click **My Network Connections** and choose **Properties**.

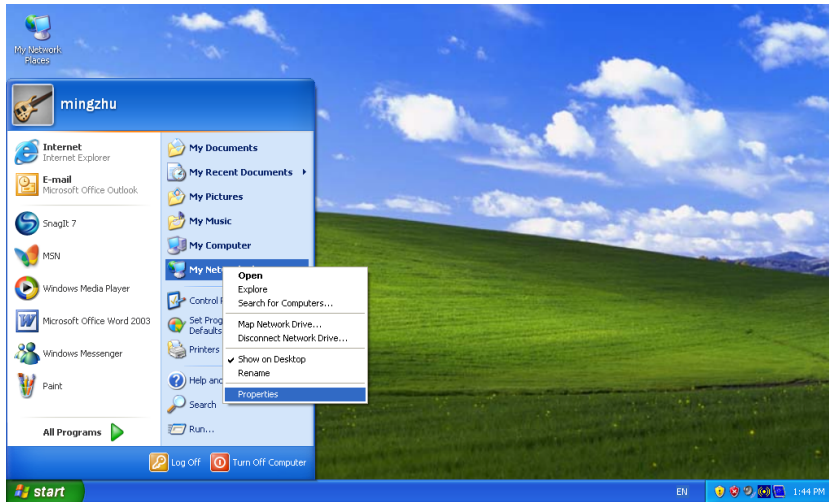

- 2) On the **My Network Connections** window, right-click **Wireless Network Connection** and choose **Enable** to enable wireless network function.

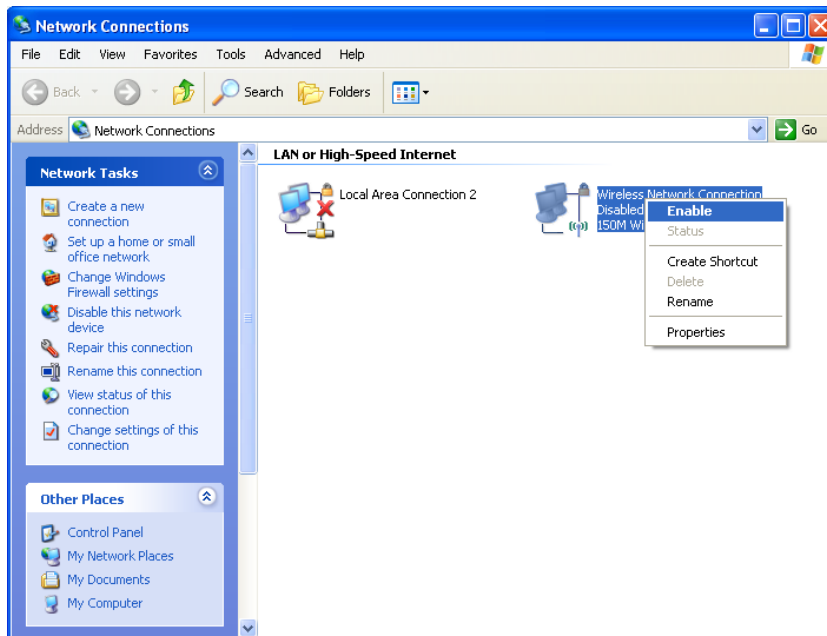

- 3) Right-click the wireless connection icon “” on the screen of the PC and then select **View Available Wireless Networks**.



- 4) Highlight the SSID of the AP (Here is TP-LINK) and click **Connect** to add to the network.

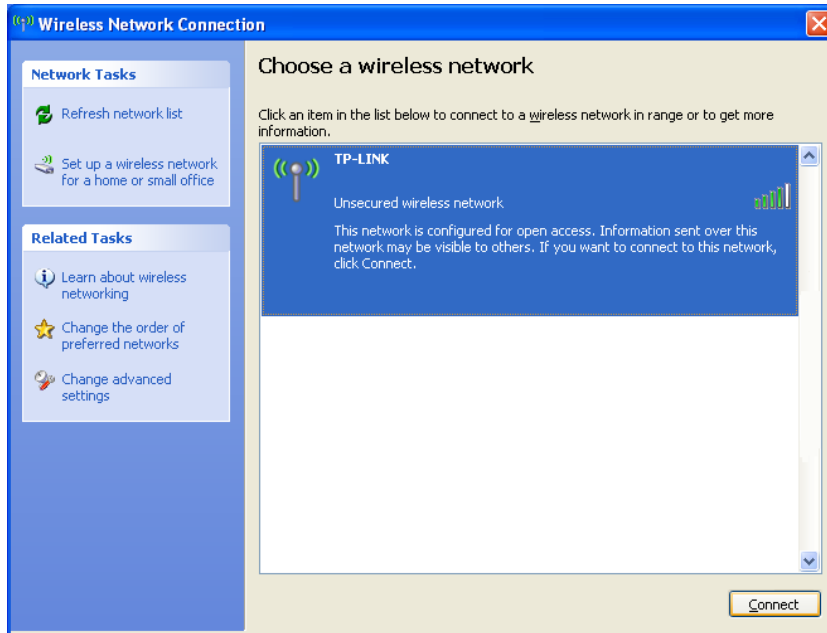

- 5) Then the following page will display, which indicates you have been successfully added to the network wirelessly.

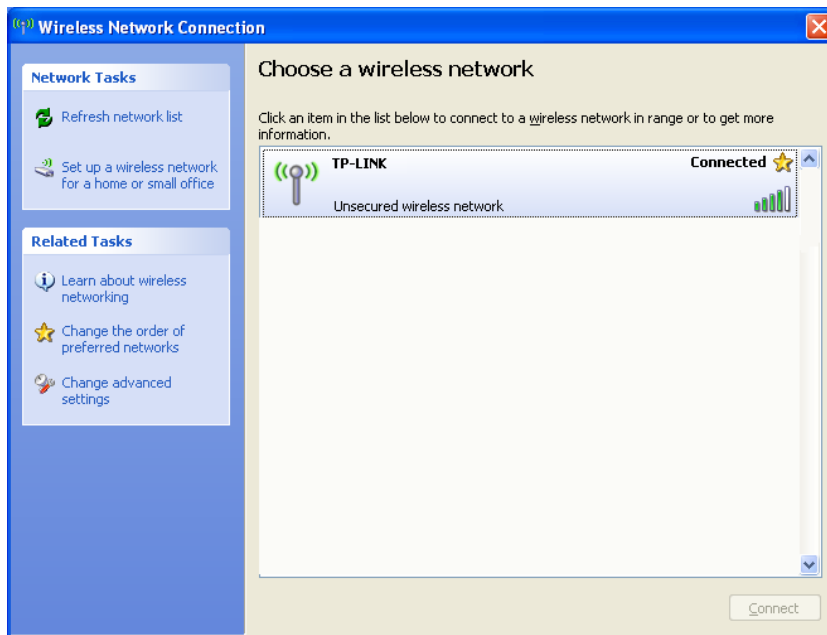

Appendix B: Factory Defaults

Item	Default Value
Common Default Settings	
Username	admin
Password	admin
IP Address	192.168.0.254
Subnet Mask	255.255.255.0
Wireless	
SSID	TP-LINK_XXXXXX
Wireless Security	Disable
Wireless MAC Address Filtering	Disable
DHCP	
DHCP Server	Enable
Start IP Address	192.168.0.100
End IP Address	192.168.0.199
Address Lease Time	120 minutes (Range:1 ~ 2880 minutes)
Default Gateway (optional)	0.0.0.0
Primary DNS (optional)	0.0.0.0
Secondary DNS (optional)	0.0.0.0

 **Note:**

The default SSID is TP-LINK_XXXXXX (XXXXXX indicates the last unique six characters of each device's MAC address). This value is case-sensitive.

Appendix C: Troubleshooting

T1. How do I restore my Access Point's configuration to its factory default settings?

With the Access Point powered on, use a pin to press and hold the **RESET** button on the rear panel for more than 8 seconds before releasing it.

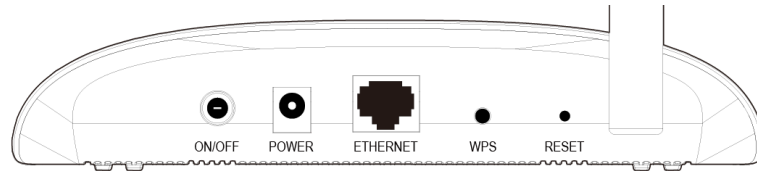

Note:

Once the Access Point is reset, the current configuration settings will be lost and you will need to reconfigure the Access Point.

T2. What can I do if I forget my password?

- 1) Restore the Access Point's configuration to its factory default settings. If you don't know how to do that, please refer to previous section **T1**;
- 2) Use the default user name and password: **admin, admin**;
- 3) Try to reconfigure your AP by following the instructions of this UG.

T3. What can I do if I cannot access the web-based configuration page?

Assign a static IP address 192.168.0.100 for your computer first before logging in the management page. Here takes the procedures in Windows 7 for example.

- 1) Go to **Start > Settings > Control Panel**, and then Click **View network status and tasks**.

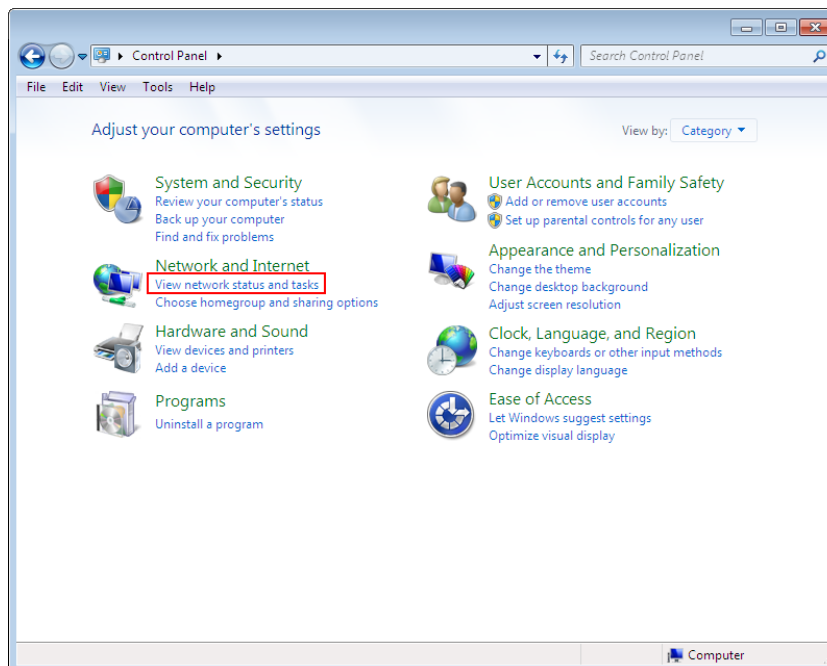

2) Click **Change adapter settings**

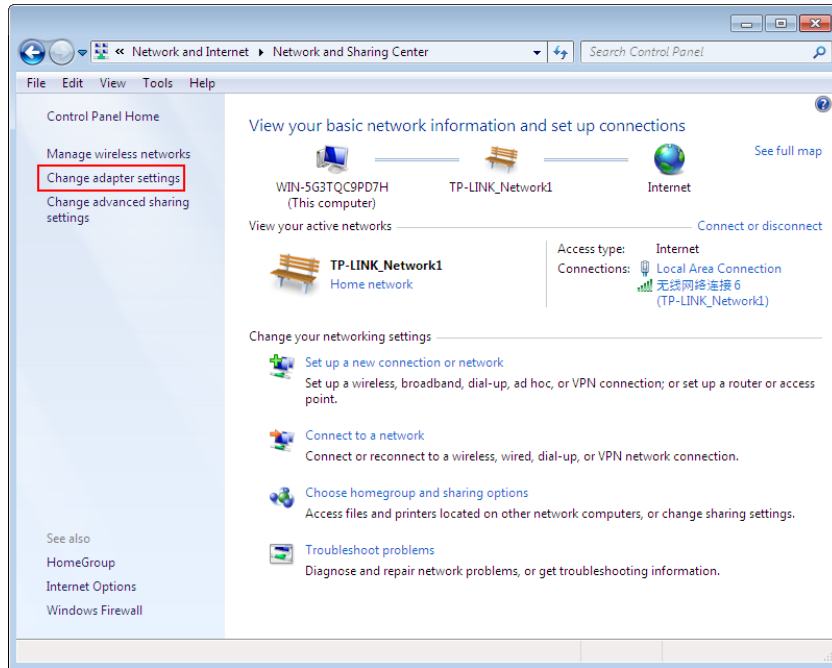

3) Right-click **Local Area Connection**, and Click **Properties**.

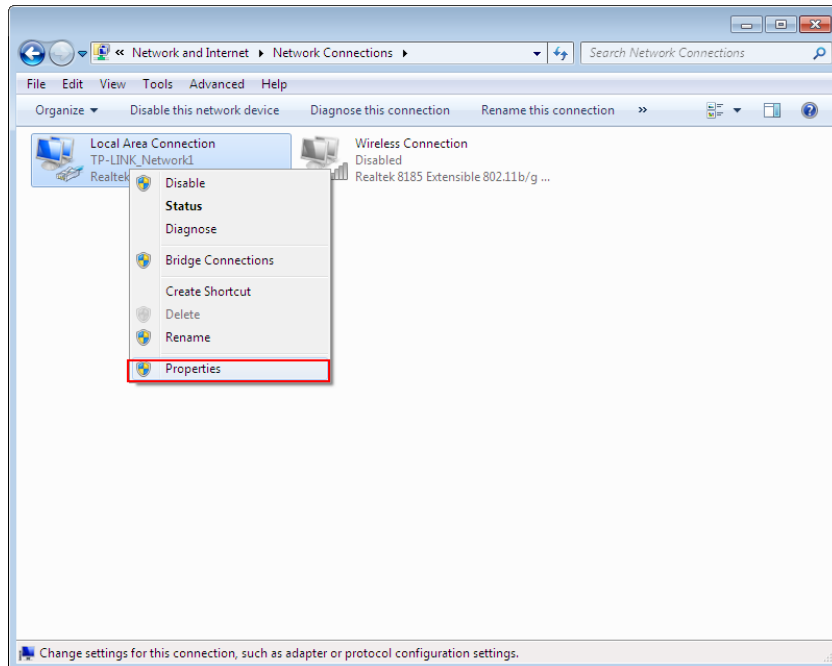

- 4) Double-click **Internet Protocol Version 4 (TCP/IPv4)**.

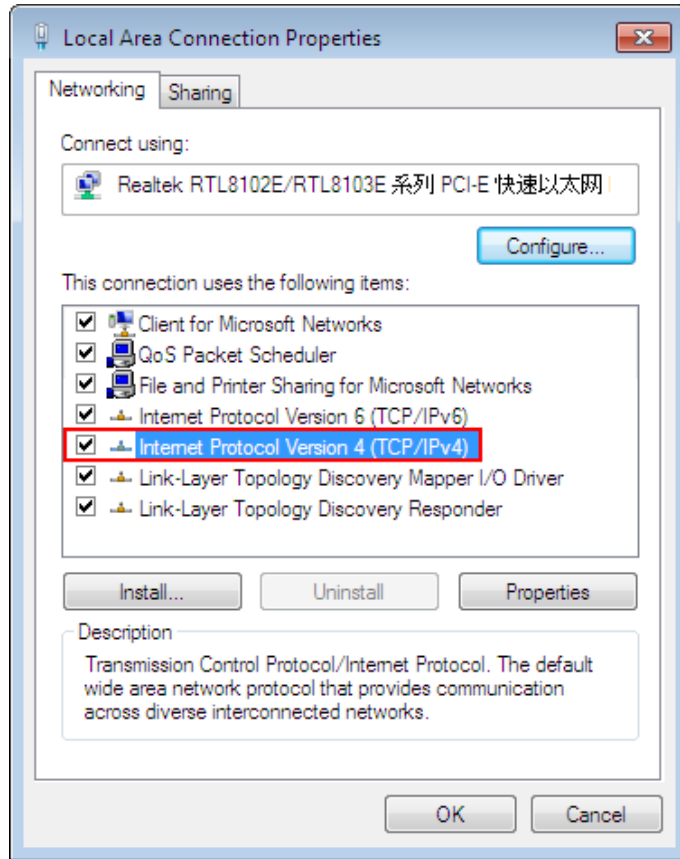

- 5) Select **Use the following IP address**, enter the 192.168.0.100 into the **IP address** field, 255.255.255.0 into the **Subnet mask** field.

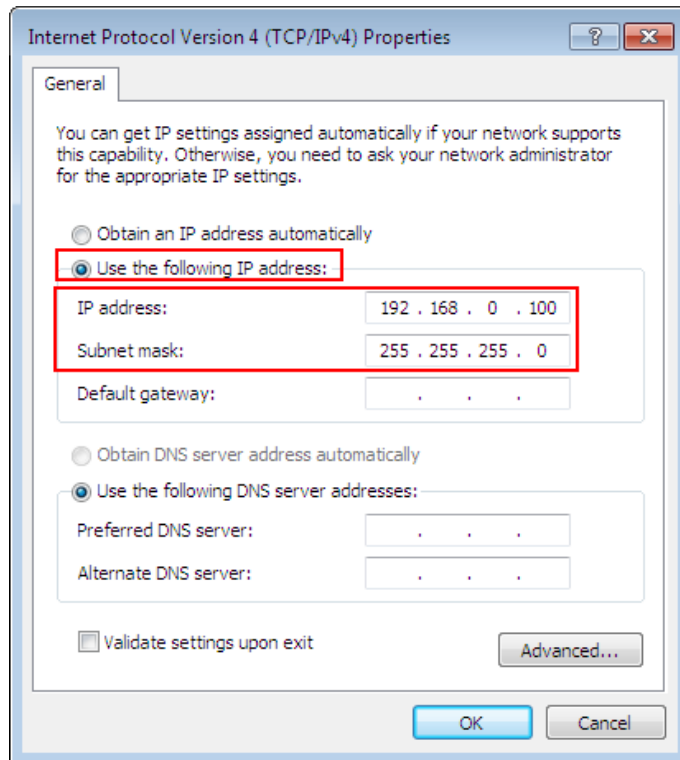

Now, try to log on to the Web-based configuration page again after the above settings have been configured. If you still cannot access the configuration page, please restore your Access Point's factory default settings and reconfigure your Access Point following the instructions of this QIG. Please feel free to contact our Technical Support if the problem persists.

Note:

While the reconfiguration is done, you need to change the IP address settings as below. Then, with the correct hardware connection, you can surf the Internet successfully.

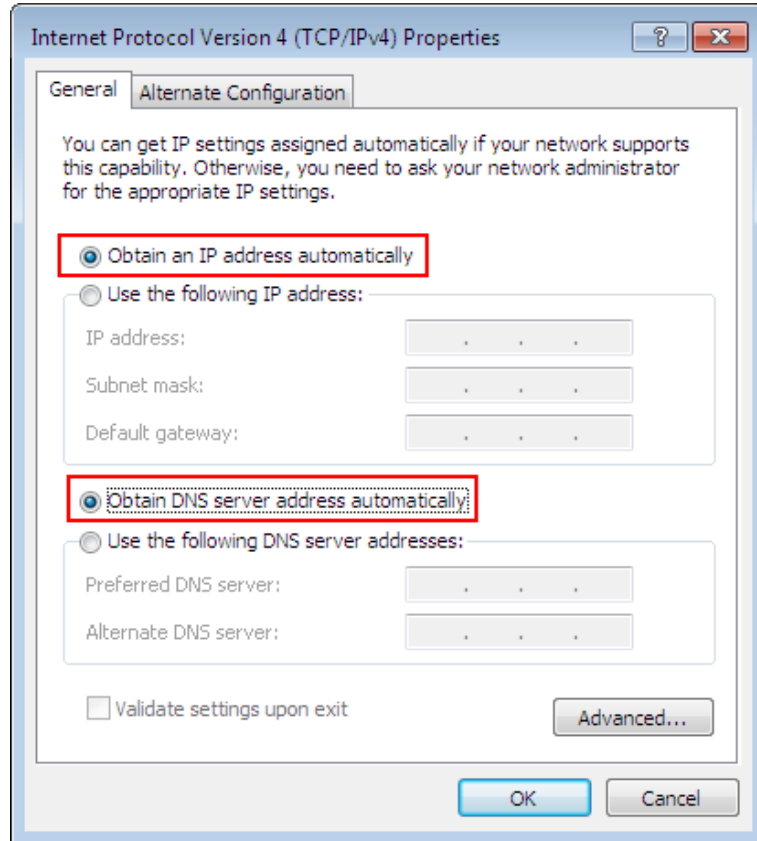

Appendix D: Specifications

General	
Standards and Protocols	IEEE 802.3, 802.3u, 802.11n, 802.11b and 802.11g, TCP/IP, DHCP
Safety & Emission	FCC、CE
Ports	One 10/100M Auto-Negotiation LAN RJ45 port, supporting passive PoE
Cabling Type	10BASE-T: UTP category 3, 4, 5 cable (maximum 100m) EIA/TIA-568 100Ω STP (maximum 100m) 100BASE-TX: UTP category 5, 5e cable (maximum 100m) EIA/TIA-568 100Ω STP (maximum 100m)
Wireless	
Frequency Band	2.4~2.4835GHz
Radio Data Rate	11n: up to 150Mbps (Automatic) 11g: 54/48/36/24/18/12/9/6M (Automatic) 11b: 11/5.5/2/1M (Automatic)
Frequency Expansion	DSSS(Direct Sequence Spread Spectrum)
Modulation	DBPSK, DQPSK, CCK, OFDM, 16-QAM, 64-QAM
Security	WEP/WPA/WPA2/WPA2-PSK/WPA-PSK
Sensitivity @PER	130M: -68dBm@10% PER 108M: -68dBm@10% PER; 54M: -68dBm@10% PER 11M: -85dBm@8% PER; 6M: -88dBm@10% PER 1M: -90dBm@8% PER
Antenna Gain	5dBi
Physical and Environment	
Working Temperature	0°C~40 °C (32~104°F)
Working Humidity	10% ~ 90% RH, Non-condensing
Storage Temperature	-40 ~ 70°C (-40 ~ 158°F)
Storage Humidity	5% ~ 90% RH, Non-condensing

Appendix E: Glossary

802.11b - The 802.11b standard specifies a wireless networking at 11 Mbps using direct-sequence spread-spectrum (DSSS) technology and operating in the unlicensed radio spectrum at 2.4GHz, and WEP encryption for security. 802.11b networks are also referred to as Wi-Fi networks.

802.11g - specification for wireless networking at 54 Mbps using direct-sequence spread-spectrum (DSSS) technology, using OFDM modulation and operating in the unlicensed radio spectrum at 2.4GHz, and backward compatibility with IEEE 802.11b devices, and WEP encryption for security.

Access Point (AP) - A wireless LAN transceiver or "base station" that can connect a wired LAN to one or many wireless devices. Access points can also bridge to each other.

DNS (Domain Name System) – An Internet Service that translates the names of websites into IP addresses.

Domain Name - A descriptive name for an address or group of addresses on the Internet.

DoS (Denial of Service) - A hacker attack designed to prevent your computer or network from operating or communicating.

DSL (Digital Subscriber Line) - A technology that allows data to be sent or received over existing traditional phone lines.

ISP (Internet Service Provider) - A company that provides access to the Internet.

MTU (Maximum Transmission Unit) - The size in bytes of the largest packet that can be transmitted.

SSID - A **S**ervice **S**et **I**dentification is a thirty-two character (maximum) alphanumeric key identifying a wireless local area network. For the wireless devices in a network to communicate with each other, all devices must be configured with the same SSID. This is typically the configuration parameter for a wireless PC card. It corresponds to the ESSID in the wireless Access Point and to the wireless network name.

WEP (Wired Equivalent Privacy) - A data privacy mechanism based on a 64-bit or 128-bit or 152-bit shared key algorithm, as described in the IEEE 802.11 standard.

Wi-Fi - A trade name for the 802.11b wireless networking standard, given by the Wireless Ethernet Compatibility Alliance (WECA, see <http://www.wi-fi.net>), an industry standards group promoting interoperability among 802.11b devices.

WLAN (Wireless Local Area Network) - A group of computers and associated devices communicate with each other wirelessly, which network serving users are limited in a local area.

WPA (Wi-Fi Protected Access) - WPA is a security technology for wireless networks that improves on the authentication and encryption features of WEP (Wired Equivalent Privacy). In fact, WPA was developed by the networking industry in response to the shortcomings of WEP. One of the key technologies behind WPA is the Temporal Key Integrity Protocol (TKIP). TKIP addresses the encryption weaknesses of WEP. Another key component of WPA is built-in authentication that WEP does not offer. With this feature, WPA provides roughly comparable security to VPN tunneling with WEP, with the benefit of easier administration and use. This is similar to 802.1x support and requires a RADIUS server in order to implement. The Wi-Fi Alliance will call this, WPA-Enterprise. One variation of WPA is called WPA Pre Shared Key or WPA-PSK for short - this

provides an authentication alternative to an expensive RADIUS server. WPA-PSK is a simplified but still powerful form of WPA most suitable for home Wi-Fi networking. To use WPA-PSK, a person sets a static key or "passphrase" as with WEP. But, using TKIP, WPA-PSK automatically changes the keys at a preset time interval, making it much more difficult for hackers to find and exploit them. The Wi-Fi Alliance will call this, WPA-Personal.