



Prestigio
THE ART OF HI-TECH



Car Video Recorder

RoadRunner 570 / RoadRunner 570GPS

User Manual

Version 1.0

www.prestigio.com

About this user manual

This user manual is specially designed to detail the device's functions and features.

- Please read this manual before using the device to ensure safe and proper use.
- Descriptions are based on the device's default settings.
- Prestigio continuously strives to improve its products. Due to software upgrading, some contents in this user manual may be different from your product. Prestigio reserves the rights to revise this user manual or withdraw it at any time without prior notice. Please take your product as standard.

Conventions used in this manual

In this user manual, we use the following symbols to indicate useful and important information:



Caution: provides safety precaution and important information.



Note: gives additional information.



Tips: usage tips.

- > The order of options or menus you must select to perform a step.

Note:

The italicized text in this manual is only for RoadRunner 570GPS.

Contents

1. Unboxing	1
Inside your package	1
Device overview	1
2. Getting started.....	2
Insert a microSD card	2
Install the suction mount	2
Charge the battery	2
Main screen.....	3
3. Settings.....	4
Settings menu	4
LDWS (Lane Departure Warning System)	5
4. Recording.....	6
Record a video	6
Take a picture.....	6
5. File management	6
Browse files	6
Choose a file.....	6
Delete a file	6
Lock and unlock a file	6
6. Playback.....	7
Play video on DVR	7
Playback on your TV/Monitor	7
Playback on GPS video player	7
7. Specifications	8

1. Unboxing



Inside your package

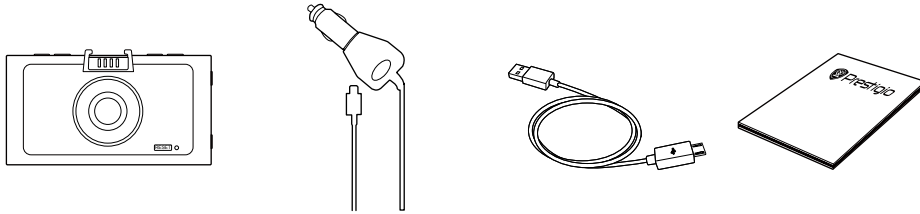

RoadRunner 570

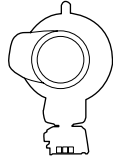

RoadRunner 570GPS

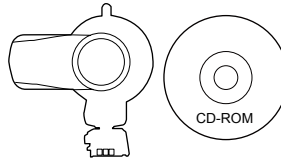

- Car video recorder
- Mini USB cable
- CD
- Warranty card

- Car charger
- Suction mount
- Quick start guide

Device overview

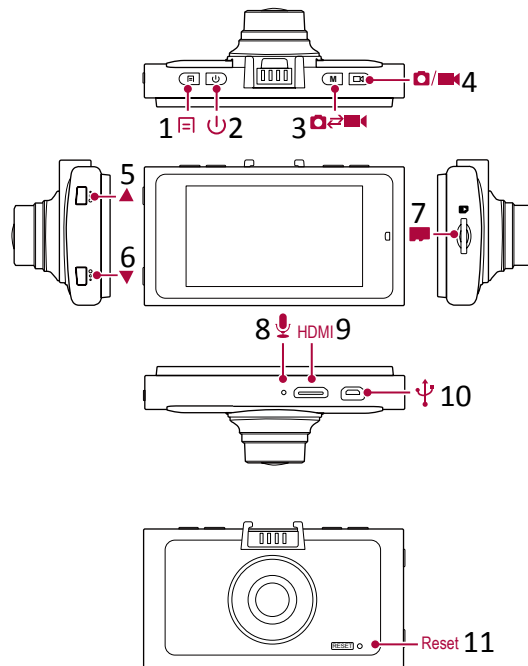

- 1 Menu button
- 2 Power button
- 3 Mode button
- 4 Video/Playback/OK button
- 5 Up button
- 6 Down button

- 7 SD card slot
- 8 Microphone
- 9 HDMI port
- 10 Mini USB port
- 11 Reset button

2. Getting started

2

Insert a microSD card

Before starting video recording, please insert a microSD card (not included) into the slot until it locks in place.

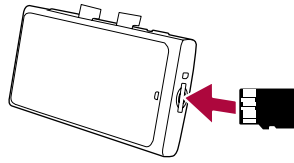

The device will automatically recognize it as default storage and all the data will be saved on this card.

Install the suction mount

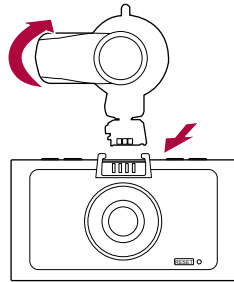

1. Match the mounting slots of the device and the suction mount, and press the suction mount until it locks in place.
2. Remove the protection plastic film from the suction cup, and position the device on the clean windshield or dashboard.
3. Hold firmly against the surface and rotate the lock knob. The mount will suction and stick firmly onto the surface.



To unmount, press the buckle and pull out the suction mount.

Charge the battery

Before using the device for the first time, please fully charge the Li-ion battery. The battery will be completely charged in 2-3 hours.

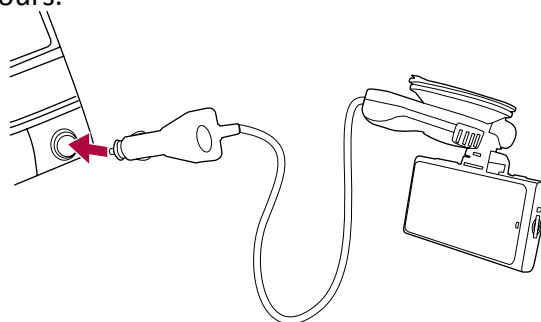

- Using the car charger: Charge the device through cigarette lighter. The device will start charging after the car engine is turned on.



The GPS receiver is built in the suction mount. Please connect the car charger to the mini USB port on the mount.

- Using the included mini USB cable: connect the device to AC 5V adapter or the USB port of a computer/laptop.

Main screen

Press power button to turn on device, you will enter preview mode, and get below screen:



- | | | | |
|---|----------------|----|-----------------------------|
| 1 | Resolution | 7 | Loop recording |
| 2 | Recording icon | 8 | Microphone |
| 3 | Recording time | 9 | Memory card |
| 4 | Battery | 10 | Speed and GPS location |
| 5 | Motion detect | 11 | Plate number and LOGO stamp |
| 6 | GPS | 12 | Date and time |



When the device is connected to the GPS signal, the icon  will be green.

3. Settings

Before recording, you can set up the device according to your requirements.

- In preview mode, press [F] to enter settings, press it again to exit. Use [←]/[→] to navigate the menu.



Settings menu

- **Resolution:** Select the resolution of recorded video: 2304x1296 (30 fps), 1920x1080 (30 fps), 1280x720 (60 fps).
- **Video quality:** Set the video quality to super fine, fine, or normal.
- **Record overwrite:** Set the video duration (1, 3, 5, or 10 minutes) for loop recording. When the microSD card is full, the device will delete the oldest unlocked video file automatically.
- **Motion detection:** Turn on or off motion detection. If there is any motion detected while the car engine is stopped, your car DVR will start recording automatically.
- **Power on record:** Set DVR to start recording when power on.
- **Power off delay:** Select a time span for DVR to power off when the car engine stops.
- **Power on delay:** Select a time span for DVR to power on when the car engine starts.
- **MIC:** Set to turn the microphone on or off.
- **Time lapse:** Set the time interval to record the same scene or the same object automatically for a long time, but show it quickly, so that a slow action appears to happen quickly.
- **Language:** Choose your language.
- **Car number set:** Set the car plate number if necessary.
- **TV type:** Choose your TV type from NTSC, and PAL.
- **Auto power off:** Set automatic power off when the device is not in use.
- **Format:** Format the memory card.



Formatting will erase all your stored data. Back up your data before proceeding.

- **Time setup:** Set time on DVR.
- **Stamp:** Add information stamp onto videos/photos.
- **Auto LCD off:** Set automatic LCD off when the device is not in use, press any button to wake up.
- **Default setting:** Restore to default setting.
- **Beep sound:** Adjust volume of beep sound.
- **Flicker:** For a given luminance, the frequency of light fluctuation that evokes a sensation of flicker. Set a right flickering frequency to avoid horizontal stripe interference.
- **Contrast:** Adjust the contrast.
- **Sharpness:** Adjust the sharpness.
- **White balance:** Select an appropriate white balance, so images have a true-to-life color range. It is for specific lighting situations.
- **EV setting:** Set exposure value to determine how much light the camera's sensor receives. For lowlight situations, use a higher exposure.
- **G-sensor set:** *Select the sensitivity of the G-sensor. The smaller the number is, the higher the sensitivity is. When reaching the sensitive value (such as collision), the recording file will be automatically protected.*
- **GPS auto update time:** *Set the GPS to update the date/time automatically.*
- **GMT setup:** *Select the local GMT (Greenwich Mean Time).*
- **GPS set up:** *Turn on or off GPS.*
- **WDR:** Turn on or off WDR (Wide Dynamic Range). WDR can enhance the brightness in dark, and adjust the brightness in backlighting.
- **LDWS detect:** Turn on or off LDWS (Lane Departure Warning System).
- **LDWS calibration:** Adjust the LDWS.
- **Active slot setup:** Set the file storage position.

- **Detector setup:** Turn on to detect if there is road camera ahead.
- **Firmware Version:** Display the current system version.

LDWS (Lane Departure Warning System)

A lane departure warning system is a mechanism designed to warn a driver when the vehicle begins to move out of its lane on freeways and arterial roads.

Note: System accuracy depends on lighting conditions and driving speed (optimum accuracy at speeds of appx. 60 km/h and higher.)

Turn on **LDWS DETECT** and **LDWS CALIBRATION**, and finish LDWS calibration as follows:



1. Press [F5] to return to preview mode.
2. Use [Up]/[Down] to adjust the position of the red line or the purple line.
3. Press [F5] to switch between the two lines.
4. Make sure that both lines are parallel to the car hood and 90° to the line marking on the road surface.
5. Press [Enter] to confirm.

4. Recording

4

Record a video

Auto video recording

Connect the device to car charger, when the car engine launches, the device will automatically turn on and start loop video recording. When shut off the car engine, the device will save the last file and turn off.



You can cancel it by turning off POWER ON RECORD in settings.

Manual video recording

In preview mode, press [□◀] button to start and stop video recording.

Zoom in or out

During recording, press [◀⏏] to zoom in or zoom out.

Record the sound

In preview mode or recording mode, press [◀⏏] to turn on or off microphone.

Lock a recording video

During recording, press [M] to lock or unlock the video.

Take a picture

- Press [M] to select the picture mode, and then press [□◀] to take photos.

5. File management

5

You can manage your videos and pictures in playback mode.

Browse files

1. In preview mode, press [M] two times to enter the playback mode.
2. Press [◀⏏]/[▶⏏] to scroll through the file categories: all files, videos, photos.

Choose a file

Press [□◀] to start file choosing, and press [◀⏏]/[▶⏏] to select your desired one.

Delete a file

Press [≡] to delete one file or all the files, and press [□◀] to confirm the deletion.

Lock and unlock a file

Press [⏏] to protect or unprotect the selected file.

6. Playback



Play video on DVR

1. In playback mode, press [OK] and [Left]/[Right] to select your desired video.
2. Press [OK] to open the file, and press it again to start playing.
3. Press [Left]/[Right] to slow down or speed up playing.
4. Press [M] again to exit playback mode.

Trim a video

1. During playing, press [F] to start or stop video trimming.
2. Press [OK] to confirm and save the trimmed video.

Playback on your TV/Monitor

1. Connect the car DVR to a TV/Monitor with a HDMI cable (not included).
2. Turn on the car DVR. Follow the instructions on the TV screen or refer to your TV user manual.

Playback on GPS video player

1. Install the "Player.exe" stored on the CD-ROM included to your PC.
2. Connect the car DVR to the PC by the included mini USB cable.
3. Open the player, select the file and start playback.
4. It will show your video and tracks.



7. Specifications

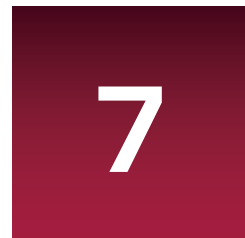

Display	2.7", 960 x 240 pixels
Processor	Amarella A7LA50D
Image sensor	3.0 MP CMOS 1/3"
View angle	170°
Video resolution	2304x1296 (30 fps), 1920x1080 (30 fps), 1280x720 (60 fps)
Video codec	MP4 (H.264)
Picture format	JPEG
Memory	up to 64GB (microSD Class 6 or above, SDHC/SDXC)
Microphone	Built-in
Motion Detection	Yes
Power source	Built-in battery, car charger
Interfaces	HDMI, mini USB, SD card
Operating temperature	0 °C ~ 45°C
Dimension	37 x 88 x 32.5 mm (H x W x D)
Weight	70 g