



# Owner's Manual IPS LED MONITOR (LED MONITOR\*)

\*LG LED Monitors are LCD Monitors with LED Backlighting.

**Please read the safety information carefully before using the product.**

**IPS LED Monitor (LED Monitor) Model List**

**25UM57**

**29UM57**

# CONTENTS

## 3 LICENSE

---

## 4 ASSEMBLING AND PREPARING

---

- 4 Product Components
- 5 Component and Button Description
- 6 Moving and Lifting the Monitor
- 7 Installing the Monitor
  - 7 - Assembling the stand base
  - 8 - Using the cable holder
  - 9 - Detaching the stand base
  - 11 - Installing onto a table
  - 12 - Adjusting the angle
  - 13 - Using the Kensington lock
  - 13 - Installing the wall mount plate
  - 14 - Installing to a wall

## 15 USING THE MONITOR

---

- 15 Connecting to a PC
  - 15 - HDMI connection
- 15 Connecting to AV Devices
  - 15 - HDMI connection
- 16 Connecting to External Devices
  - 16 - Headphone port connection

## 17 INSTALLING THE LG MONITOR SOFTWARE

---

- 17 Installing The Screen Split
- 19 Installing The Dual Controller

## 21 CUSTOMIZING SETTINGS

---

- 21 Activating the Main Menu
- 22 Customizing settings
  - 22 - Menu Settings
  - 22 - -Quick Settings
  - 23 - -Picture
  - 25 - -General
  - 26 - -Reset
  - 27 - -Game mode

## 29 TROUBLESHOOTING

---

## 31 SPECIFICATIONS

---

- 31 25UM57
- 32 29UM57
- 33 Factory support mode
- 33 HDMI Timing (Video)
- 33 Power Indicator

## 34 PROPER POSTURE

---

- 34 Proper Posture for Using the Monitor

# LICENSE

Each model has different licenses. Visit [www.lg.com](http://www.lg.com) for more information on the license.



The terms HDMI and HDMI High-Definition Multimedia Interface, and the HDMI logo are trademarks or registered trademarks of HDMI Licensing LLC in the United States and other countries.

The following content is only applied to the monitor which is sold in Europe market and which needs to meet the ErP Directive:

- \* This monitor is set to be turned off automatically in 4 hours after you turned on display if there is no adjustment to display.
- \* To make this setting be disabled, change the option to 'Off' in OSD menu of "Automatic Standby".

# ASSEMBLING AND PREPARING

## Product Components

Please check whether all the components are included in the box before using the product. If there are missing components, contact the retail store where you purchased the product. Note that the product and components may look different from those shown here.



User Manual/Card



HDMI Cable



Power Cord

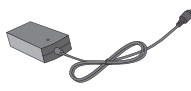

AC-DC Adapter

( Depending on the country )

or



AC-DC Adapter

( Depending on the country )

25UM57



Stand Base

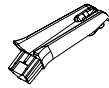

Stand Body



Screw Cover



Screws x2

29UM57



Stand Base

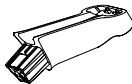

Stand Body



Screw Cover



Screws x2



### CAUTION

- Always use genuine components to ensure safety and product performance.
- The product warranty will not cover damage or injury caused by the use of counterfeit components.



### NOTE

- Note that the components may look different from those shown here.
- Without prior notice, all information and specifications in this manual are subject to change to improve the performance of the product.
- To purchase optional accessories, visit an electronics store or online shopping site or contact the retail store where you purchased the product.
- The DisplayPort cable may not be available in some areas.

## Component and Button Description

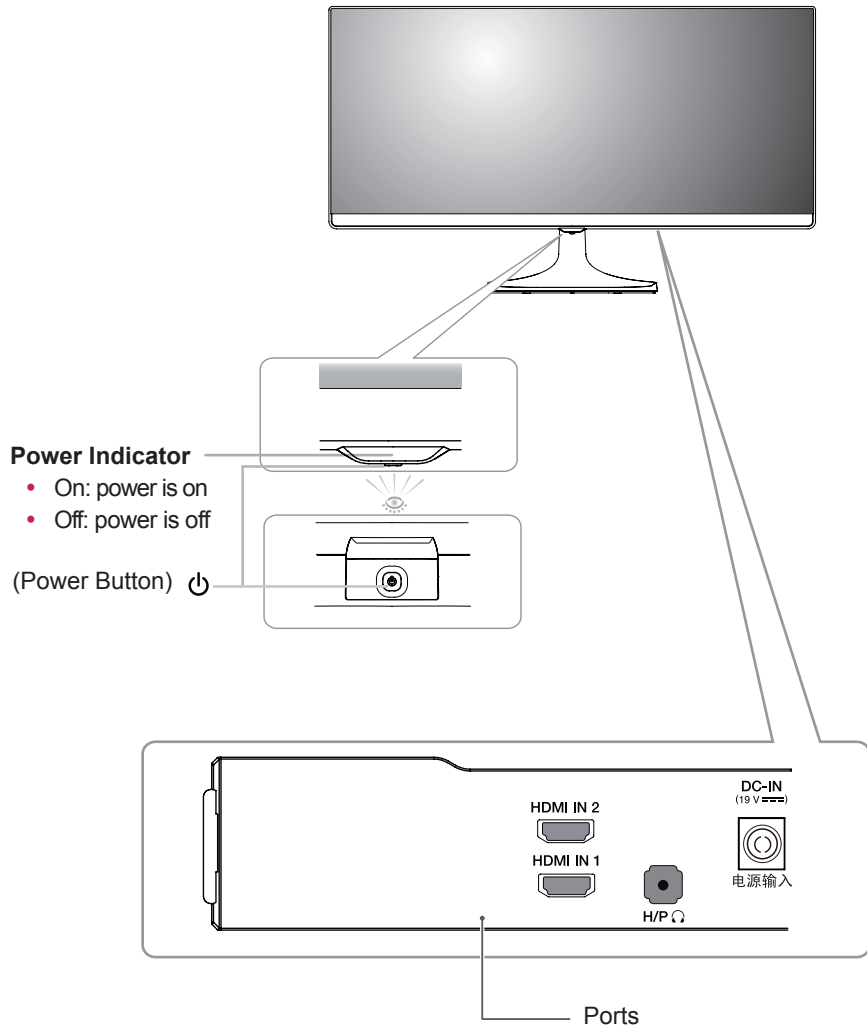

## Moving and Lifting the Monitor

When moving or lifting the monitor, follow these instructions to prevent the monitor from being scratched or damaged and to ensure safe transportation regardless of its shape or size.

- It is advisable to place the monitor in the original box or packing material before attempting to move it.
- Before moving or lifting the monitor, disconnect the power cord and all cables.
- Hold the top and bottom of the monitor frame firmly. Do not hold the panel itself.

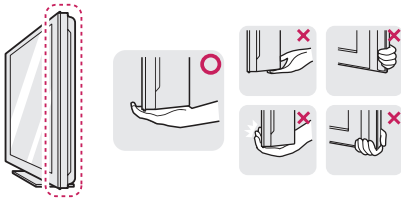

- When holding the monitor, the screen should face away from you to prevent it being scratched.

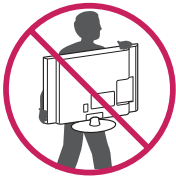

- When moving the monitor, avoid any strong shock or vibrations to the product.
- When moving the monitor, keep it upright, never turn the monitor on its side or tilt it sideways.

### CAUTION

- As far as possible, avoid touching the monitor screen. This may result in damage to the screen or some of the pixels used to create images.

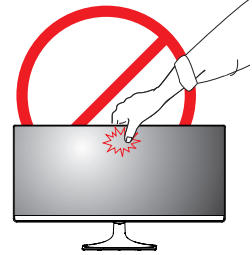

- If you use the monitor panel without the stand base, its joystick button may cause the monitor to become unstable and fall, resulting in damage to the monitor or human injury. In addition, this may cause the joystick button to malfunction.

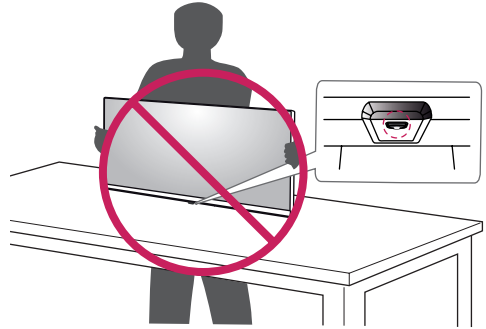

## Installing the Monitor

### Assembling the stand base

25UM57

- 1 Place the screen face down.



#### CAUTION

- To protect the screen from scratches, cover the surface with a soft cloth.

- 2 Check the direction of the stand body (front, back) and then mount the stand body onto the stand hinge. Tighten two screws into the back of the stand body.

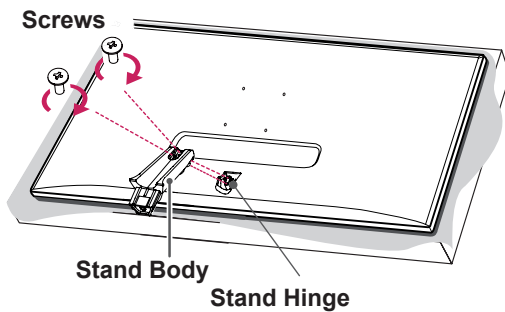

- 4 Attach the screw cover.

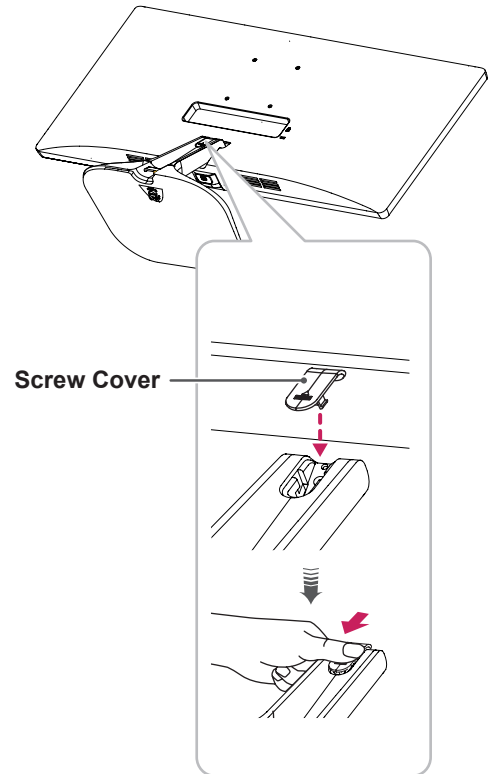

- 3
  - 1 Attach the **Stand Base** to **Stand Body**.
  - 2 Tighten the screw to the right.

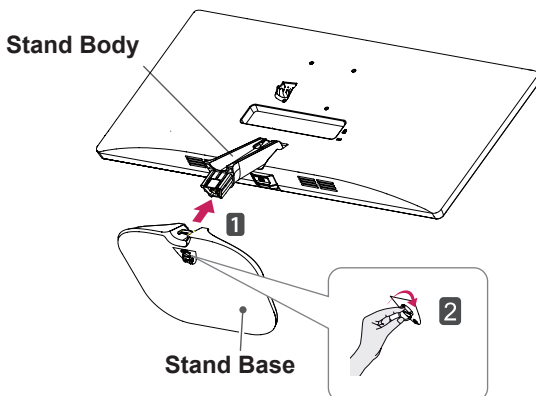

**29UM57**

1 Place the screen face down.

**CAUTION**

- To protect the screen from scratches, cover the surface with a soft cloth.

2 Check the direction of the stand body (front, back) and then mount the stand body onto the stand hinge. Tighten two screws into the back of the stand body .

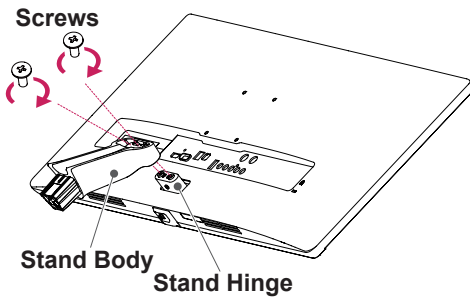

3 **1** Attach the **Stand Base** to **Stand Body**.  
**2** Tighten the screw to the right.

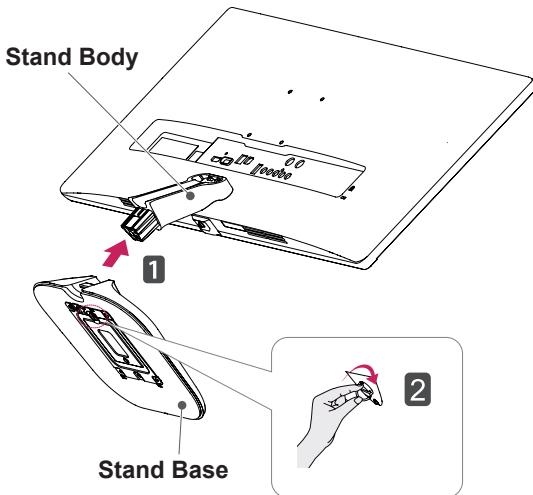

4 Attach the screw cover.

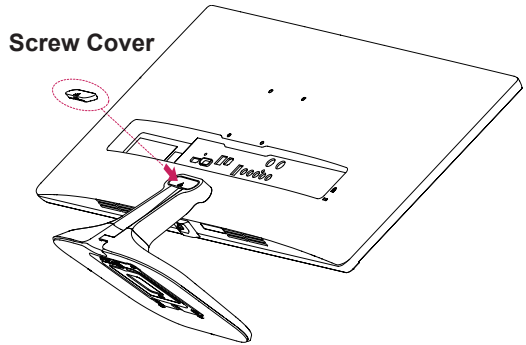

**CAUTION**

Applying excessive force when tightening the screws may cause damage to the monitor. Damage caused in this way will not be covered by the product warranty.

**CAUTION**

It may hurt your foot off the stand, so be careful.

**Using the cable holder**

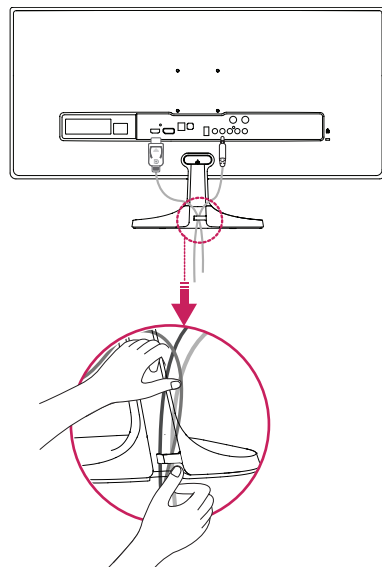



## Detaching the stand base

25UM57

- 1 Place the screen face down.

### CAUTION

- To protect the screen from scratches, cover the surface with a soft cloth.

- 2 Remove the screw cover.

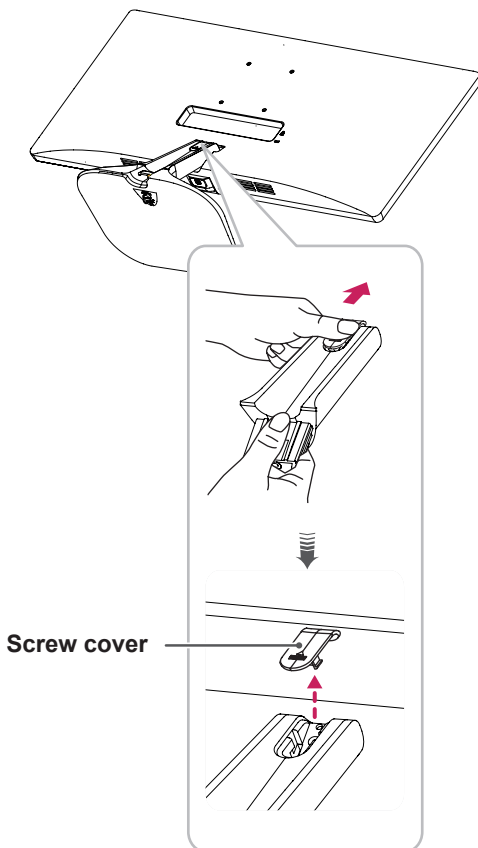

- 3 Remove the two screws on the back of stand body.

As shown in the illustration, disconnect the **stand body from the stand hinge**.

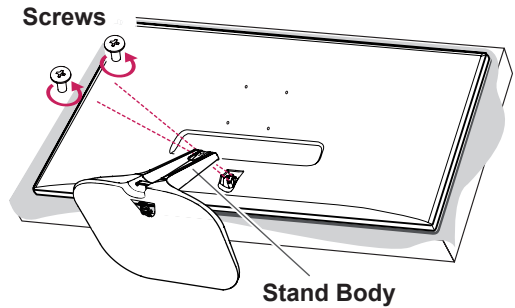

- 4
  - 1 Turn the screw to the left.
  - 2 Pull out the **Stand Base**.

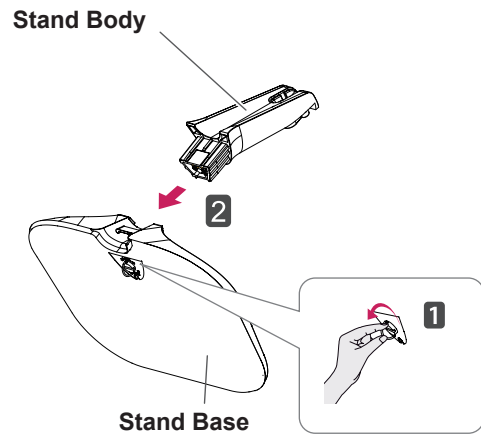

29UM57

- 1 Place the screen face down.

**CAUTION**

- To protect the screen from scratches, cover the surface with a soft cloth.

- 2 Remove the screw cover.

Screw cover

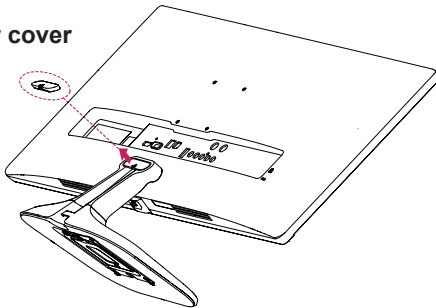

- 3 Remove the two screws on the back of stand body.

As shown in the illustration, disconnect the **stand body from the stand hinge**.

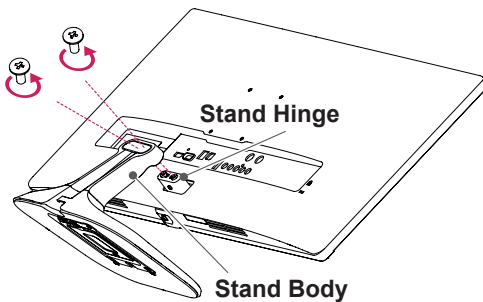

- 4
  - 1 Turn the screw to the left.
  - 2 Pull out the **Stand Base**.

Stand Body

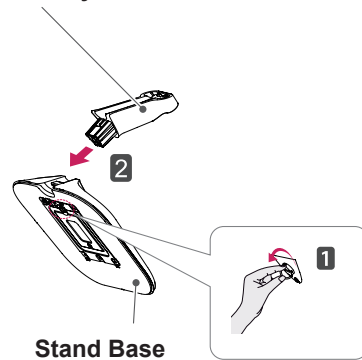
**CAUTION**

- Illustrations in this document represent typical procedures, so they may look different from the actual product.
- Do not carry the monitor upside down by just holding the stand base. This may cause the monitor to fall off the stand and could result in personal injury.
- When lifting or moving the monitor, do not touch the monitor screen. Applying force or pressure may damage the monitor screen. Instead, hold the stand body or the plastic frame of the product.

**CAUTION**

- The components in the illustrations may differ from the actual product.
- Do not carry the monitor upside down, as this may cause it to fall off its stand and result in damage or injury.
- To avoid damaging the screen when lifting or moving the monitor, only hold the stand or the plastic cover. This avoids putting unnecessary pressure on the screen.

## Installing onto a table

- 1 Lift the monitor and place it on the table in an upright position.

Place at least **10 cm** away from the wall to ensure sufficient ventilation.

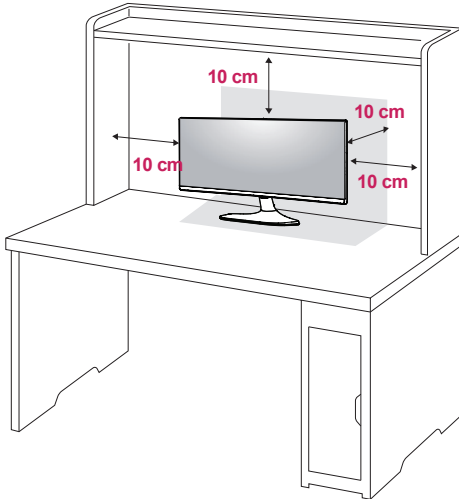

- 2 Connect the adapter to the monitor, then plug the power cord into the power outlet.

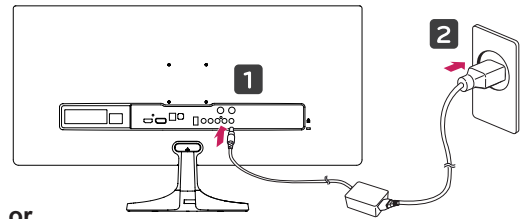

or

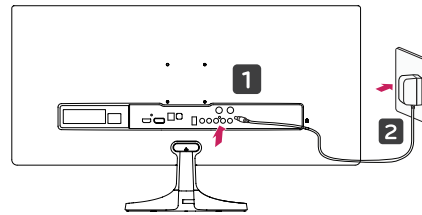

- 3 Press the  (Power) button on the bottom of the monitor to turn it on.



### CAUTION

- Unplug the power cord prior to moving or installing the monitor. There is risk of electric shock.

## Adjusting the angle

- 1 Place the monitor in an upright position, mounted on the stand base.
- 2 Adjust the angle of the screen. The angle of the screen can be adjusted forwards or backwards for a comfortable viewing experience.

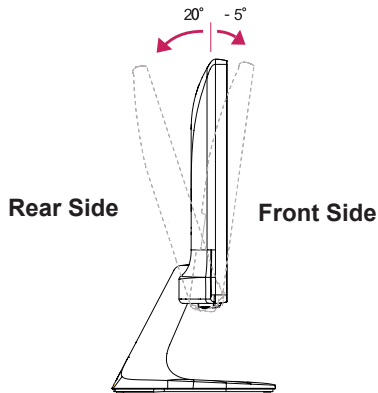

### ! WARNING

- To avoid injury to the fingers when adjusting the screen, do not hold the lower part of the monitor's frame as illustrated below.

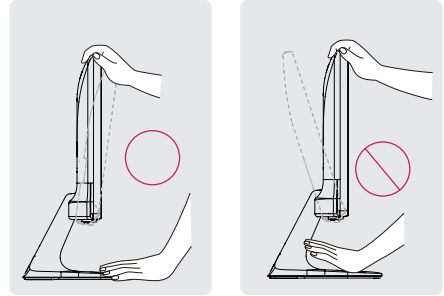

- Be careful not to touch or press the screen area when adjusting the angle of the monitor.

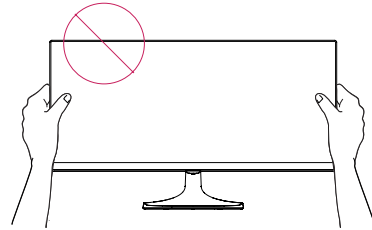

## Using the Kensington lock

The Kensington security system connector is located at the back of the Monitor set.

For more information on installation and usage, refer to the Kensington lock user manual or visit the website at <http://www.kensington.com>.

Connect the Kensington security system cable between the Monitor set and a table.

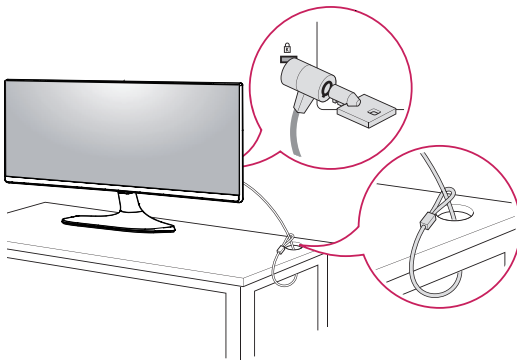

### ! NOTE

- Use of the Kensington lock is optional. The accessories can be purchased at your local electronics store.

## Installing the wall mount plate

This monitor supports the specification of the standard wall mount plate or compatible device.

- 1 Place the screen face down. To protect the screen from scratches, cover the surface with a soft cloth.
- 2 Place the wall mount plate onto the monitor and align it with the screw holes.
- 3 Using a screwdriver, tighten the four screws to fix the plate onto the monitor.

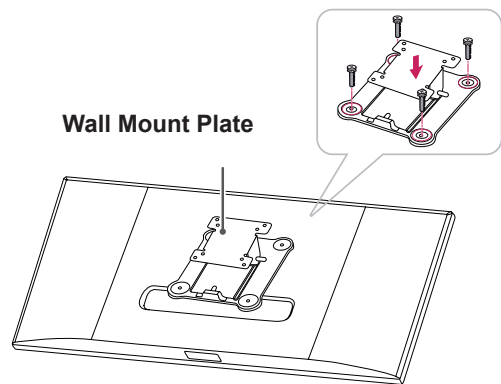

### ! NOTE

- The wall mount plate is sold separately.
- For more information on installation, refer to the wall mount plate's installation guide.
- Be careful not to use excessive force when mounting the wall mount plate, as this can damage the monitor's screen.

## Installing to a wall

Install the monitor at least 10 cm away from the wall and leave about 10 cm of space at each side of the monitor to ensure sufficient ventilation. Detailed installation instructions can be obtained from your local retail store. Please refer to the manual to install and set up a tilting wall mounting bracket.

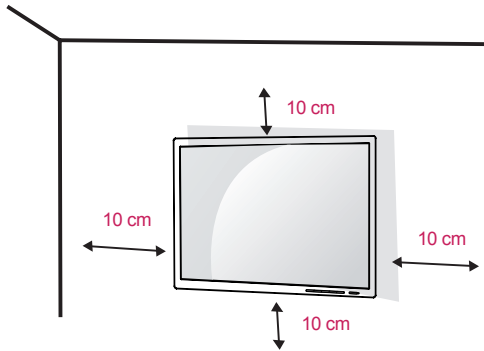

To install the monitor to a wall, attach a wall mounting bracket (optional) to the back of the monitor. Make sure that the wall mounting bracket is securely fixed to the monitor and to the wall.

- 1 If you use screw longer than standard, the monitor might be damaged internally.
- 2 If you use improper screw, the product might be damaged and drop from mounted position. In this case, LG Electronics is not responsible for it.

<b>Wall Mount (A x B)</b>	75 x 75
<b>Stand Screw</b>	M4 x 10 mm
<b>Required Screws</b>	4



### CAUTION

- Unplug the power cord before moving or installing the monitor to avoid electric shocks.
- Installing the monitor on the ceiling or on a slanted wall may result in the monitor falling off, which could lead to injury. Please use the genuine LG wall mounting bracket. For more information, contact your local retail store or a qualified installer.
- Applying excessive force when fastening screws may cause damage to the monitor. Damage caused in this way will not be covered by the product warranty.
- Use the wall mounting bracket and screws that conform to the VESA standard. Damage caused by the use or misuse of inappropriate components will not be covered by the product warranty.
- Screw length from outer surface of back cover should be under 8mm.

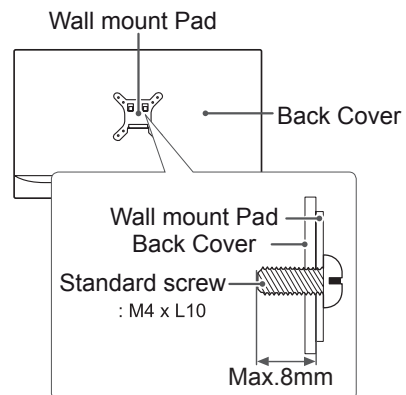

### NOTE

- Use the screws specified by the VESA standard.
- The wall mount kit includes the installation guide and all necessary parts.
- The wall mounting bracket is optional. The accessories can be purchased at your local retail store.
- The length of the screw may differ for each wall mounting bracket. Ensure the correct length screw is used.
- For more information, please refer to the user manual for the wall mounting bracket.

# USING THE MONITOR

## Connecting to a PC

- This monitor supports the \*Plug and Play feature.  
\*Plug and Play: A feature that allows you to add a device to your computer without having to reconfigure anything or install any manual drivers.

## HDMI connection

Transmits the digital video and audio signals from your PC and A/V devices to the monitor. Connect your PC and AV device to the monitor with the HDMI cable as illustrated below. Press the menu button and then select the input option from the input menu.

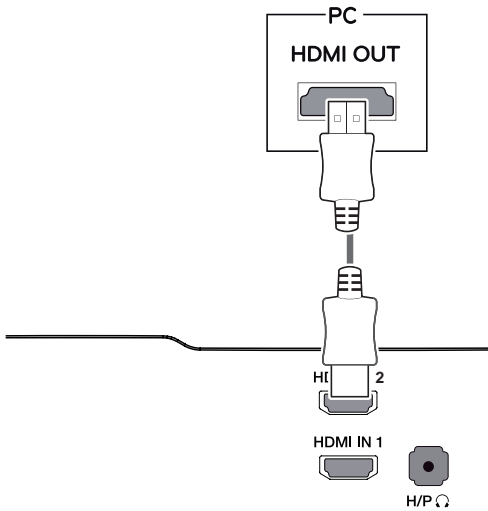

**NOTE**

- HDMI PC may cause device compatibility issues.
- Using a DVI to HDMI cable may cause compatibility issues.

## Connecting to AV Devices

### HDMI connection

Transmits the digital video and audio signals from your PC and A/V devices to the monitor. Connect your PC and AV device to the monitor with the HDMI cable as illustrated below.

Press the menu button and then select the input option from the input menu.

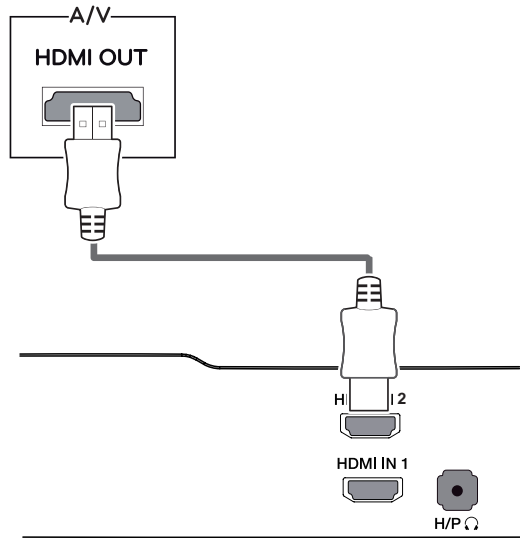

**NOTE**

- Using a DVI to HDMI cable may cause compatibility issues.

## Connecting to External Devices

### Headphone port connection

Use the headphone port to connect a peripheral device to the monitor. Connect as illustrated.

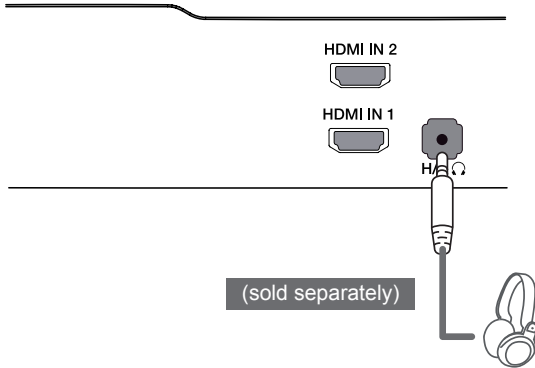

#### ! NOTE

- For an angle plug earphone, it is difficult to connect it with a peripheral device, so use a straight type.



Angle Type

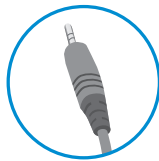

Straight Type

#### ! NOTE

- Depending on the audio settings of the PC and external device, headphone and speaker functions may be limited.



# INSTALLING THE LG MONITOR SOFTWARE

## Installing The Screen Split

Insert the software CD included in the product packaging into your PC's CD drive and install the Screen Split.

The installation screen images are for reference only. The actual installation screen images may vary depending on the model.

- 1 Set the default Web browser to Internet Explorer.



- 3 Follow the instructions to proceed with the installation.

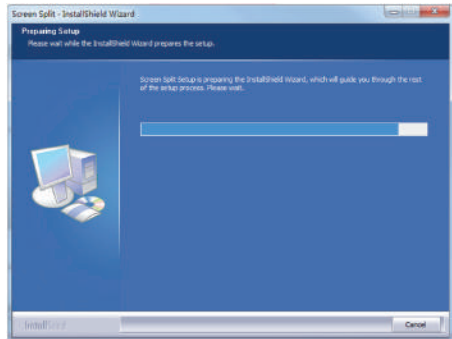

- 2 Click the "Screen Split" on the CD's main screen. When the file download window appears, click the Run button. (The file download window may vary depending on the operating system and the Internet Explorer version, but the installation procedures are same.)

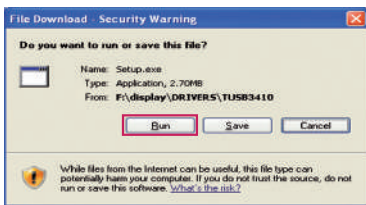

- 4 Check "I accept the terms of the agreement" on the License Agreement screen and then click the [Next] button.

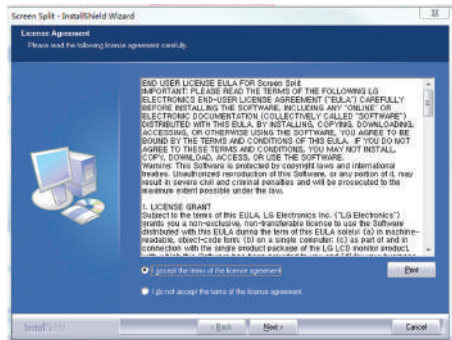

### CAUTION

- Service Pack 1 or higher is required for Windows 7 & Windows 8.

5 The Screen Split installation starts as shown below.

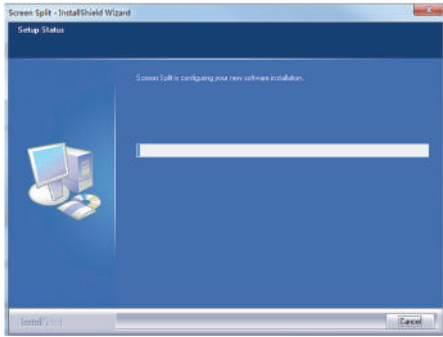

6 When the installation is complete, restart your system.

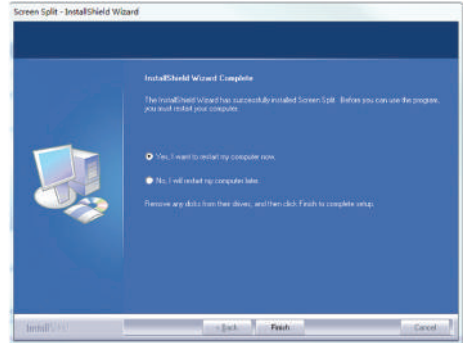

**NOTE**

- Screen Split: This program automatically splits the program window as desired.
- ※ Monitor Selection only supported in extend display.
- ※ This program supported Windows 7 & Windows 8.

**NOTE**

If you run Screen Split, the Screen Split icon [  ] appears in the system tray at the right bottom of the PC screen.



Right-click the Screen Split icon and select a layout you want.

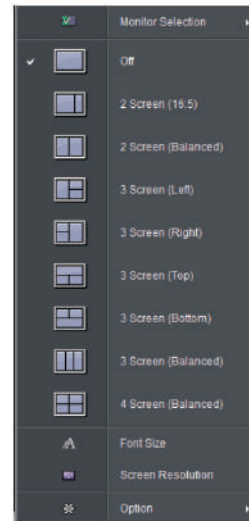

## Installing The Dual Controller

Insert the software CD included in the product packaging into your PC's CD drive and install the Dual Controller.

The installation screen images are for reference only. The actual installation screen images may vary depending on the model.

- 1 Set the default Web browser to Internet Explorer.



- 2 Click the "Dual Controller" on the CD's main screen. When the file download window appears, click the Run button. (The file download window may vary depending on the operating system and the Internet Explorer version, but the installation procedures are same.)

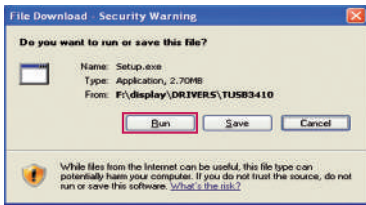

- 3 Follow the instructions to proceed with the installation.

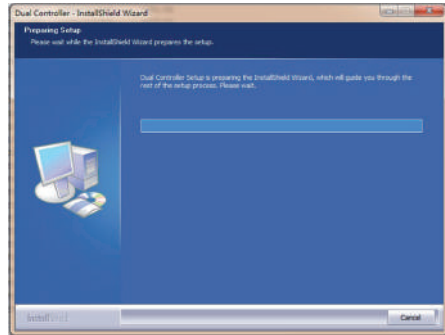

- 4 Check "I accept the terms of the agreement" on the License Agreement screen and then click the [Next] button.

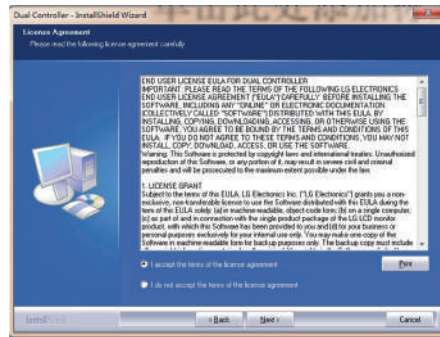

- 5 Click the install button.

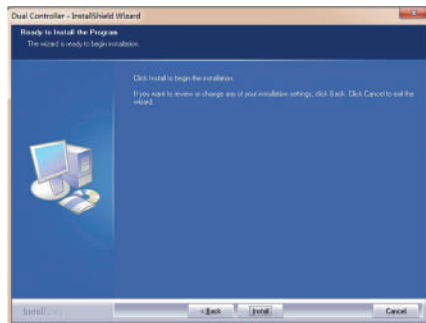

### CAUTION

- Service Pack 1 or higher is required for Windows 7 & Windows 8.1.

6 The Dual Controller installation starts as shown below.

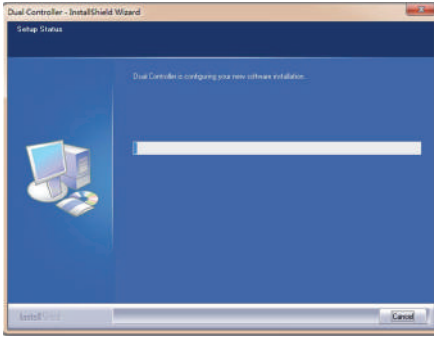

7 When the installation is complete, restart your system.

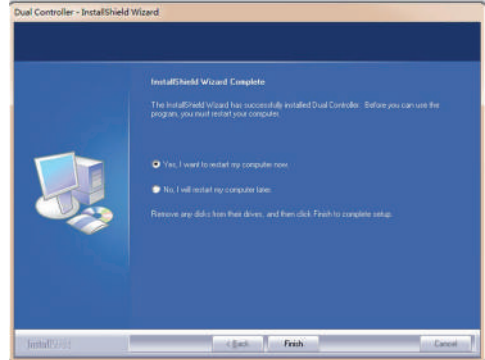

**NOTE**

If you run Dual Controller, the Dual Controller icon [  ] appears in the system tray.



Click the Dual Controller icon and select a layout you want.

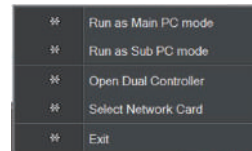

# CUSTOMIZING SETTINGS

## Activating the Main Menu

- 1 Press the joystick button on the bottom of the monitor.
- 2 Move the joystick up/down (▲/▼) and left/right(◀/▶) to set the options.
- 3 Press the joystick button once more to exit the main menu.

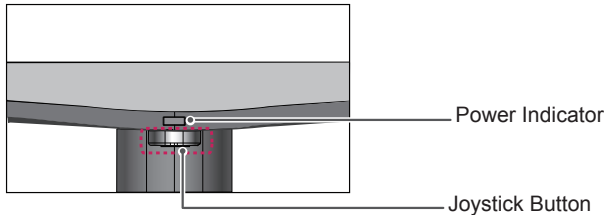

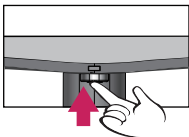
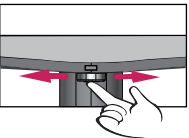
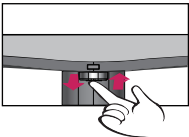
Button	Menu Status	Description
	<b>Main menu disabled</b>	Enables the main menu.
	<b>Main menu enabled</b>	Exits the main menu. (Holding down the button to turn off the monitor: You can turn off the monitor this way at any time, including when the OSD is on.)
	◀ <b>Main menu disabled</b>	Adjusts the monitor volume level.
	◀ <b>Main menu enabled</b>	Enters the menu features.
	▶ <b>Main menu disabled</b>	Adjusts the monitor volume level.
	▶ <b>Main menu enabled</b>	Operates the Input change.
	▲ <b>Main menu disabled</b>	Enables the main menu.
	▲ <b>Main menu enabled</b>	Enters the game mode feature.
	▼ <b>Main menu disabled</b>	Enables the main menu.
	▼ <b>Main menu enabled</b>	Turns off the monitor.

## Main Menu Features

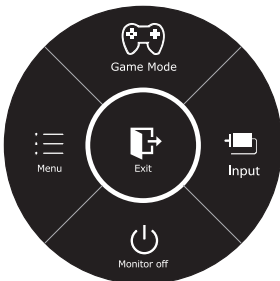

Main Menu	Description
<b>Menu</b>	Configures the screen settings.
<b>Game Mode</b>	Optimizes the screen for game mode.
<b>Input</b>	Sets input mode.
<b>Monitor off</b>	Turns off the monitor.
<b>Exit</b>	Exits the main menu.

Ⓞ Long press: Monitor off.

## Customizing settings

### Menu Settings

#### -Quick Settings

- 1 To view the **OSD menu**, press the **joystick button** at the bottom of the monitor and then enter the **Menu**.
- 2 Go to **Quick Settings > Brightness** by moving the joystick.
- 3 Configure the options following the instructions that appear in the bottom right corner.
- 4 To return to the upper menu or set other menu items, move the joystick to ◀ or pressing (⊙ / OK) it.
- 5 If you want to exit the OSD menu, move the joystick to ◀ until you exit.

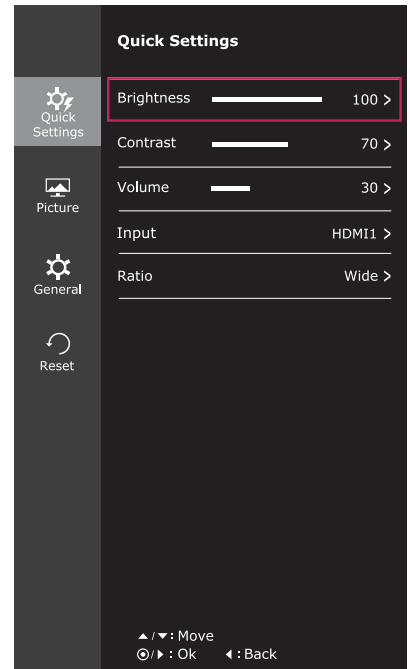

Each option is described below.

Menu > Quick Settings	Description										
<b>Brightness</b>	Adjusts the color contrast and brightness of the screen.										
<b>Contrast</b>											
<b>Volume</b>	Adjusts the volume.										
	<div style="border: 1px solid black; padding: 5px;"> <p><b>NOTE</b></p> <ul style="list-style-type: none"> <li>• Jog joystick button down (⊙) in the Volume menu will enable/disable the Mute function.</li> </ul> </div>										
<b>Input</b>	Selects the input mode.										
<b>Ratio</b>	Adjusts the screen ratio.										
	<table border="1"> <tr> <td><b>Wide</b></td> <td>Displays the video in wide-screen, regardless of the video signal input.</td> </tr> <tr> <td><b>Original</b></td> <td>Displays a video according to the input video signal aspect ratio.</td> </tr> <tr> <td><b>Cinema 1</b></td> <td>Enlarges the screen with an aspect ratio of 21:9. (at 1080p)</td> </tr> <tr> <td><b>Cinema 2</b></td> <td>Enlarges the screen with an aspect ratio of 21:9 including the black box area at the bottom for subtitles. (at 1080p)</td> </tr> <tr> <td><b>1:1</b></td> <td>The aspect ratio is not adjusted from the original.</td> </tr> </table>	<b>Wide</b>	Displays the video in wide-screen, regardless of the video signal input.	<b>Original</b>	Displays a video according to the input video signal aspect ratio.	<b>Cinema 1</b>	Enlarges the screen with an aspect ratio of 21:9. (at 1080p)	<b>Cinema 2</b>	Enlarges the screen with an aspect ratio of 21:9 including the black box area at the bottom for subtitles. (at 1080p)	<b>1:1</b>	The aspect ratio is not adjusted from the original.
<b>Wide</b>	Displays the video in wide-screen, regardless of the video signal input.										
<b>Original</b>	Displays a video according to the input video signal aspect ratio.										
<b>Cinema 1</b>	Enlarges the screen with an aspect ratio of 21:9. (at 1080p)										
<b>Cinema 2</b>	Enlarges the screen with an aspect ratio of 21:9 including the black box area at the bottom for subtitles. (at 1080p)										
<b>1:1</b>	The aspect ratio is not adjusted from the original.										

#### NOTE

- The display may look the same for Wide, Original options at the recommended resolution (2560 x 1080).
- The ratio is disabled in the interlaced signal.

## -Picture

- 1 To view the **OSD menu**, press the **joystick button** at the bottom of the monitor and then enter the **Menu**.
- 2 Go to **Picture** by moving the joystick.
- 3 Configure the options following the instructions that appear in the bottom right corner.
- 4 To return to the upper menu or set other menu items, move the joystick to ◀ or pressing (⊙ / OK) it.
- 5 If you want to exit the OSD menu, move the joystick to ◀ until you exit.

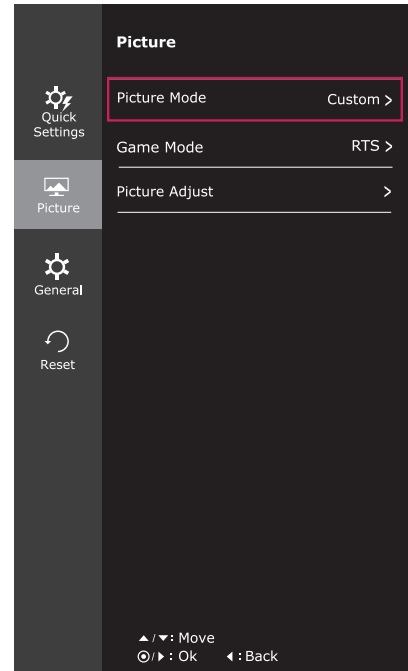

Each option is described below.

Menu > Picture	Description	
<b>Picture Mode</b>	<b>Custom</b>	Allows the user to adjust each element. The color mode of the main menu can be adjusted.
	<b>Reader 1</b>	It is a mode that the screen is adjusted to the best for the newspaper. If you want screen more bright, you can control brightness in Menu OSD.
	<b>Reader 2</b>	It is a mode that the screen is adjusted to the best for the cartoon. If you want screen more bright, you can control brightness in Menu OSD.
	<b>Photo</b>	Optimizes the screen to view photos.
	<b>Cinema</b>	Optimizes the screen to improve the visual effects of a video.
<b>Game Mode</b>	<b>Gamer</b>	Brightness, Contrast, Sharpness, Gamma, Color Temp, Black Stabilizer, Response Time, DAS Mode, and Motion 240 functions can be customized as Gamer.
	<b>FPS 1</b>	Game Mode functions are optimized for FPS games.
	<b>FPS 2</b>	The Black Stabilizer value is greater than that of FPS 1. It is suitable for very dark FPS games.
	<b>RTS</b>	Game Mode functions are optimized for RTS games.

Picture Adjust	Picture	<b>Black Stabilizer</b>	<p>Black Stabilizer : You can control the black contrast to have better visibility in dark scenes. Increasing the Black Stabilizer value brightens the low gray level area on the screen. (You can easily distinguish objects on dark game screens.) Reducing the Black Stabilizer value darkens the low gray level area and increases the dynamic contrast on the screen.</p>	
		<b>Sharpness</b>	Adjusts the sharpness of the screen.	
		<b>Black Level</b>	Sets the offset level (for HDMI only).	
			• <b>Offset:</b> as a reference for a video signal, this is the darkest color the monitor can display.	
			<b>High</b>	The picture of the screen gets brighter.
		<b>Low</b>	The picture of the screen gets darker.	
		<b>Response Time</b>	Sets a response time for displayed pictures based on the speed of the screen. For a normal environment, it is recommended that you use Normal. For a fast-moving picture, it is recommended that you use High. Setting to High may cause image sticking.	
	<b>High</b>		Sets the response time to High.	
	<b>Middle</b>		Sets the response time to Middle.	
	<b>Low</b>		Sets the response time to Low.	
	<b>Off</b>		Sets the response time to Off.	
	Color	<b>Gamma</b>	Set your own gamma value. : Gamma 0, Gamma 1, Gamma 2 on the monitor, high gamma values display whitish images and low gamma values display blackish images. If user don't want adjusted gamma, user can select Gamma off.	
		<b>Color Temp</b>	Selects the factory default picture color. <b>Warm:</b> Sets the screen color to a reddish tone. <b>Medium:</b> Sets the screen color between a red and blue tone. <b>Cool:</b> Sets the screen color to a bluish tone.	
<b>Custom</b>				
<b>Red Green Blue</b>			You can customize the picture color using Red, Green, and Blue colors.	
<b>Six Color</b>		Meets the user requirements for colors through adjusting the color and saturation of the six colors( <b>Red_Hue, Red_Saturation, Green_Hue, Green_Saturation, Blue_Hue, Blue_Saturation, Cyan_Hue, Cyan_Saturation, Magenta_Hue, Magenta_Saturation, Yellow_Hue, Yellow_Saturation</b> ) and saving the settings.		
	*Hue: Adjusts tone of the screen. *Saturation: Adjusts the saturation of the screen colors. The lower the value, less saturated and bright the colors become. The higher the value, the more saturated and dark the colors become.			
<b>Reset</b>	Returns the color settings to the default settings.			



## -General

- 1 To view the **OSD menu**, press the **joystick button** at the bottom of the monitor and then enter the **Menu**.
- 2 Go to **General** by moving the joystick.
- 3 Configure the options following the instructions that appear in the bottom right corner.
- 4 To return to the upper menu or set other menu items, move the joystick to ◀ or pressing (⊙ / OK) it.
- 5 If you want to exit the OSD menu, move the joystick to ◀ until you exit.

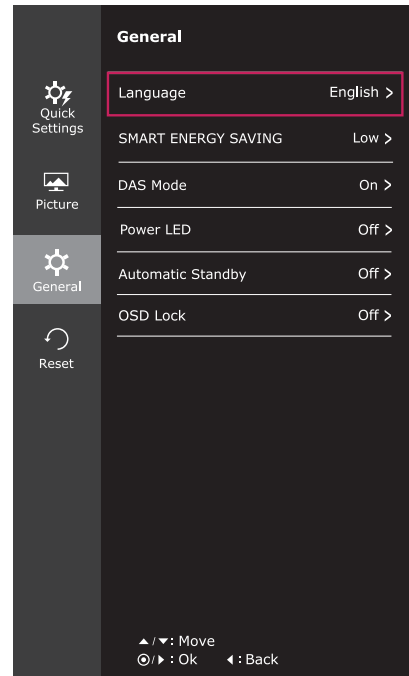

Each option is described below.

Menu > General	Description	
<b>Language</b>	To choose the language in which the control names are displayed.	
<b>SMART ENERGY SAVING</b>	<b>High</b>	Enables SMART ENERGY SAVING you can save energy with this energy- high efficient function.
	<b>Low</b>	Enables SMART ENERGY SAVING you can save energy with this energy- low efficient function.
	<b>Off</b>	Disables SMART ENERGY SAVING .
<b>DAS Mode</b>	<b>On</b>	You can enjoy faster game ensuring your commands appear onscreen without delay. (The screen flickers when turning DAS Mode on/off.)
	<b>Off</b>	Turns DAS Mode off.
<b>Power LED</b>	Turns the power indicator on the front side of the monitor on/off.	
	<b>On</b>	The power indicator is automatically turned on.
	<b>Off</b>	The power indicator is automatically turned on.
<b>Automatic Standby</b>	The monitor will automatically switch to standby mode after a certain period.	
<b>OSD Lock</b>	Prevents incorrect key input.	
	<b>On</b>	Key input is disabled.
	<div style="border: 1px solid black; padding: 5px;"> <p><b>NOTE</b></p> <p>All functions except for the OSD Lock mode and the Exit button for Brightness, Contrast, Volume, Input, and General are disabled.</p> </div>	
	<b>Off</b>	Key input is enabled.

**NOTE**

- SMART ENERGY SAVING: Conserve energy by using luminance compensation algorithm.
- Saving Data depends on the Panel. So, those values should be different from each panel and panel vendor. If option of SMART ENERGY SAVING is High or Low, monitor luminance become higher or lower depend on source.
- If option of SMART ENERGY SAVING is High or Low, Picture Mode will automatically be Custom.

## -Reset

- 1 To view the **OSD menu**, press the **joystick button** at the bottom of the monitor and then enter the **Menu**.
- 2 Go to **Reset** by moving the joystick.
- 3 Configure the options following the instructions that appear in the bottom right corner.
- 4 To return to the upper menu or set other menu items, move the joystick to ◀ or pressing (⊙ / OK) it.
- 5 If you want to exit the OSD menu, move the joystick to ◀ until you exit.

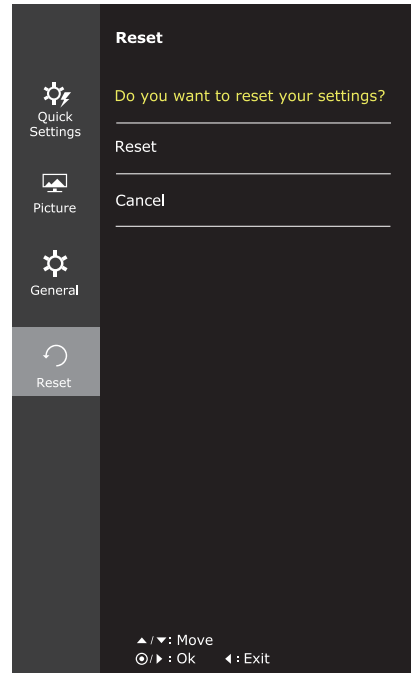

Each option is described below.

Menu > Reset	Description
<b>Do you want to reset your settings?</b>	
<b>Reset</b>	Returns to the default settings.
<b>Cancel</b>	Cancel the select.

## -Game mode

- 1 Press the joystick button on the bottom of the monitor.
- 2 Go to **Game mode** by moving the joystick button to ▲.
- 3 Configure the options following the instructions that appear in the bottom.

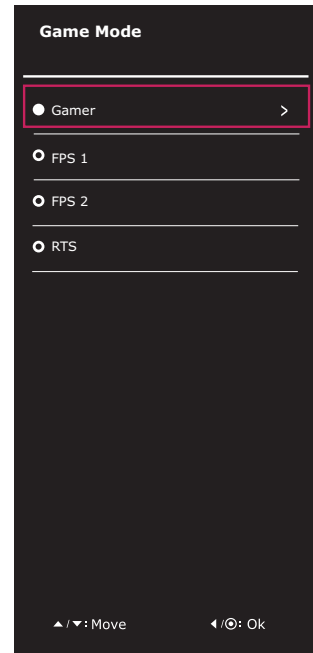

Each option is described below.

Memu> Game Mode		Description		
Game Mode	Gamer	<b>Brightness</b>	Adjusts the color contrast and brightness of the screen.	
		<b>Contrast</b>		
		<b>Sharpness</b>	Adjusts the sharpness of the screen.	
		<b>Gamma</b>	"Set your own gamma value. : Gamma 0, Gamma 1, Gamma 2 on the monitor, high gamma values display whitish images and low gamma values display blackish images. If user don't want adjusted gamma, user can select Gamma off."	
		<b>Color Temp</b>	<b>Red</b>	You can customize the picture color using Red, Green, and Blue colors.
			<b>Green</b>	
			<b>Blue</b>	
		<b>Black Stabilizer</b>	"Black Stabilizer: You can control the black contrast to have better visibility in dark scenes. Increasing the Black Stabilizer value brightens the low gray level area on the screen. (You can easily distinguish objects on dark game screens.)Reducing the Black Stabilizer value darkens the low gray level area and increases the dynamic contrast on the screen."	
		<b>Response Time</b>	"Sets a response time for displayed pictures based on the speed of the screen. For a normal environment,it is recommended that you use Middle. For a fast-moving picture, it is recom-mended that you use High.Setting the response time to High may cause image sticking."	
			<b>High</b>	Sets the response time to High.
			<b>Middle</b>	Sets the response time to Middle.
			<b>Low</b>	Sets the response time to Low.
			<b>Off</b>	Does not use the response time improvement feature.
		<b>DAS Mode</b>	<b>On</b>	You can enjoy faster game ensuring your commands appear on-screen without delay. (The screen flickers when turning DAS Mode on/off.)
<b>Off</b>	Turns DAS Mode off.			
<b>FPS 1</b>	Game Mode functions are optimized for FPS games.			
<b>FPS 2</b>	The Black Stabilizer value is greater than that of FPS 1. It is suitable for very dark FPS games.			
<b>RTS</b>	Game Mode functions are optimized for RTS games.			



#### NOTE

- If option of Picture Mode is non-Custom , SMART ENERGY SAVING will automatically be Off.

# TROUBLESHOOTING

Nothing is displayed on the screen.	
Is the monitor's power cord plugged in?	• Check if the power cord is correctly plugged in to the power outlet.
Is the power indicator on?	• Check the power cable connection and press the power button.
Is the power indicator displaying ?	• Check that the connected input is enabled (Menu - Input).
Is the power indicator blinking?	• If the monitor is in sleep mode, move the mouse or press any key on the keyboard to switch the display on. • Check if the computer is turned on.
Is the "OUT OF RANGE" message displayed?	• This occurs when signals transferred from the PC (video card) are out of the horizontal or vertical frequency range of the monitor. Please see the "Product Specification" section of this manual to set the appropriate frequency.
Is the "CHECK SIGNAL CONNECTION" message is displayed?	• This is displayed when the signal cable between the PC and the monitor is missing or disconnected. Check the cable and reconnect.

The screen retains an image.	
Does image sticking occur even when the monitor is turned off?	• Displaying a still image for a prolonged time may cause damage to the screen, resulting in the retention of the image. • Use a screen saver to protect the screen when using the monitor for a prolonged period of time.

## ! NOTE

- **Vertical Frequency:** In order to display an image, the screen must be refreshed dozens of times per second like a fluorescent lamp. The number of times the screen is refreshed per second is called vertical frequency or refresh rate and is represented by Hz.
- **Horizontal Frequency:** The time it takes to display one horizontal line is called the horizontal cycle. The number of horizontal lines displayed in one second can be calculated by dividing one by the horizontal cycle. This is called horizontal frequency and is represented by kHz.

**NOTE**

- Check if the video card's resolution or frequency is within the range allowed by the monitor and set to the recommended (optimal) resolution in **Control Panel > Display > Settings**.
- Failing to set the video card to the recommended (optimal) resolution may result in blurred text, a dimmed screen, a truncated display area or misalignment of the display.
- The configuration procedure may differ depending on your computer and/or operating system. Also, some video cards may not support certain resolutions. If this is the case, contact the manufacturer of the computer or video card for assistance.
- Some video cards may not support the 2560x1080 resolution.  
If the resolution cannot be displayed, contact the manufacturer of your video card.

<b>The display color is abnormal.</b>	
Does the display appear discolored (16 color)?	• Set the color to 24 bit (true color) or higher. In Windows, go to Control Panel > Display > Settings > Color Quality.
Does the display color appear unstable or in monochrome?	• Check if the signal cable is connected properly. Reconnect the cable or reinsert the PC's video card.
Are there spots on the screen?	• When using the monitor, pixilated spots (red, green, blue, white or black) may appear on the screen. This is normal for the LCD screen. It is not an error nor is it related to the monitor's performance.

# SPECIFICATIONS

## 25UM57

LCD Screen	Type	TFT (Thin Film Transistor) LCD (Liquid Crystal Display) Screen
	Pixel Pitch	0.2286 mm x 0.2286 mm
Resolution	Maximum Resolution	2560 x 1080 @ 60 Hz
	Recommended Resolution	2560 x 1080 @ 60 Hz
Video Signal	Horizontal Frequency	30 kHz to 90 kHz
	Vertical Frequency	56~75 Hz (PC) 56~61 Hz (AV)
	Synchronization	Separate Sync.
Input Connector	HDMI IN1, HDMI IN2 , H/P	
Power	Voltage	19 V $\pm$ 1.6 A
	Power consumption (Typ.)	On mode: 24 W (ENERGY STAR® standard)* Sleep Mode $\leq$ 0.3 W Off Mode $\leq$ 0.3 W
AC/DC adaptor	Type ADS-40SG-19-3 19032G, SHENZHEN HONOR ELECTRONIC CO.,LTD production Or type ADS-40FSG-19 19032GPG-1, SHENZHEN HONOR ELECTRONIC CO.,LTD production Or type ADS-40FSG-19 19032GPBR-1, SHENZHEN HONOR ELECTRONIC CO.,LTD production Or type ADS-40FSG-19 19032GPI-1, SHENZHEN HONOR ELECTRONIC CO.,LTD production Or type ADS-40FSG-19 19032GPCU-1, SHENZHEN HONOR ELECTRONIC CO.,LTD production Or type LCAP21A, LIEN CHANG ELECTRONIC ENTERPRISE production Or type LCAP26A-A, LIEN CHANG ELECTRONIC ENTERPRISE production Or type LCAP26A-E, LIEN CHANG ELECTRONIC ENTERPRISE production Or type LCAP26A-I, LIEN CHANG ELECTRONIC ENTERPRISE production Or type LCAP26A-B, LIEN CHANG ELECTRONIC ENTERPRISE production. Output: 19 V $\pm$ 1.7 A	
Environmental Conditions	Operating Condition	Temperature: 10°C to 35°C; Humidity: 10% to 80%
	Storing Condition	Temperature: -20°C to 60°C; Humidity: 5% to 90%
Stand Angle Adjustment	Forwards/Backwards: -5° to 20° (Head)	
Dimension	Monitor Size (Width x Height x Depth)	
	With Stand	609 mm x 383 mm x 188 mm
	Without Stand	609 mm x 287 mm x 55 mm
Weight (Without Packaging)	4.0 kg	

The specifications are subject to change without notice.

\* The power consumption level can be different by operating condition and monitor setting.

\* The On mode power consumption is measured with ENERGY STAR® test standard.

\* ENERGY STAR® is a US registered mark of the United States Environmental Protection Agency.

# SPECIFICATIONS

## 29UM57

LCD Screen	Type	TFT (Thin Film Transistor) LCD (Liquid Crystal Display) Screen
	Pixel Pitch	0.2628 mm x 0.2628 mm
Resolution	Maximum Resolution	2560 x 1080 @ 60 Hz
	Recommended Resolution	2560 x 1080 @ 60 Hz
Video Signal	Horizontal Frequency	30 kHz to 90 kHz
	Vertical Frequency	56~75 Hz (PC) 56~61 Hz (AV)
	Synchronization	Separate Sync.
Input Connector	HDMI IN1, HDMI IN2 , H/P	
Power	Voltage	19 V --- 2.0 A
	Power consumption (Typ.)	On mode: 31 W (ENERGY STAR® standard)* Sleep Mode ≤ 0.3 W Off Mode ≤ 0.3 W
AC/DC adaptor	Type ADS-45SN-19-3 19040G, SHENZHEN HONOR ELECTRONIC CO.,LTD production Or type LCAP21C, LIEN CHANG ELECTRONIC ENTERPRISE production Or type LCAP26B-E, LIEN CHANG ELECTRONIC ENTERPRISE production. Output: 19 V --- 2.1 A	
Environmental Conditions	Operating Condition	Temperature: 10°C to 35°C; Humidity: 10% to 80%
	Storing Condition	Temperature: -20°C to 60°C; Humidity: 5% to 90%
Stand Angle Adjustment	Forwards/Backwards: -5° to 20° (Head)	
Dimension	Monitor Size (Width x Height x Depth)	
	With Stand	70.3 cm x 41.4 cm x 21.3 cm
	Without Stand	70.3 cm x 32.8 cm x 6.4 cm
Weight (Without Packaging)	5.2 kg	

The specifications are subject to change without notice.

- \* The power consumption level can be different by operating condition and monitor setting.
- \* The On mode power consumption is measured with ENERGY STAR® test standard.
- \* ENERGY STAR® is a US registered mark of the United States Environmental Protection Agency.



## Factory support mode

Preset Mode	Horizontal Frequency (kHz)	Vertical Frequency (Hz)	Polarity (H/V)	Remarks
720 x 400	31.468	70.08	-/+	
640 x 480	31.469	59.94	-/-	
640 x 480	37.5	75	-/-	
800 x 600	37.879	60.317	+/+	
800 x 600	46.875	75	+/+	
1024 x 768	48.363	60	-/-	
1024 x 768	60.123	75.029	+/+	
1152 x 864	67.5	75	+/+	
1280 x 720	45	60	+/+	
1280 x 1024	63.981	60.02	+/+	
1280 x 1024	79.976	75.025	+/+	
1600 x 900	60	60	+/+	
1680 x 1050	65.290	59.954	-/+	
1920 x 1080	67.5	60	+/-	
2560 x 1080	66.7	60	-/+	

## HDMI Timing (Video)

Preset Mode	Horizontal Frequency (kHz)	Vertical Frequency (Hz)	Remarks
480P	31.50	60	
576P	31.25	50	
720P	37.50	50	
720P	45.00	60	
1080P	56.25	50	
1080P	67.50	60	

## Power Indicator

Mode	LED Color
On Mode	Light On
Power-saving	Blinking
Off Mode	Off

# PROPER POSTURE

## Proper Posture for Using the Monitor

Adjust the screen so that you can comfortably view at a slight downward angle from your natural eye level.

- Take a break for approximately ten minutes every hour to reduce any fatigue caused by long-time usage.
- The stand of the touch monitor allows the product to be used in the optimum position. Adjust the stand angle to obtain the best view of the screen.

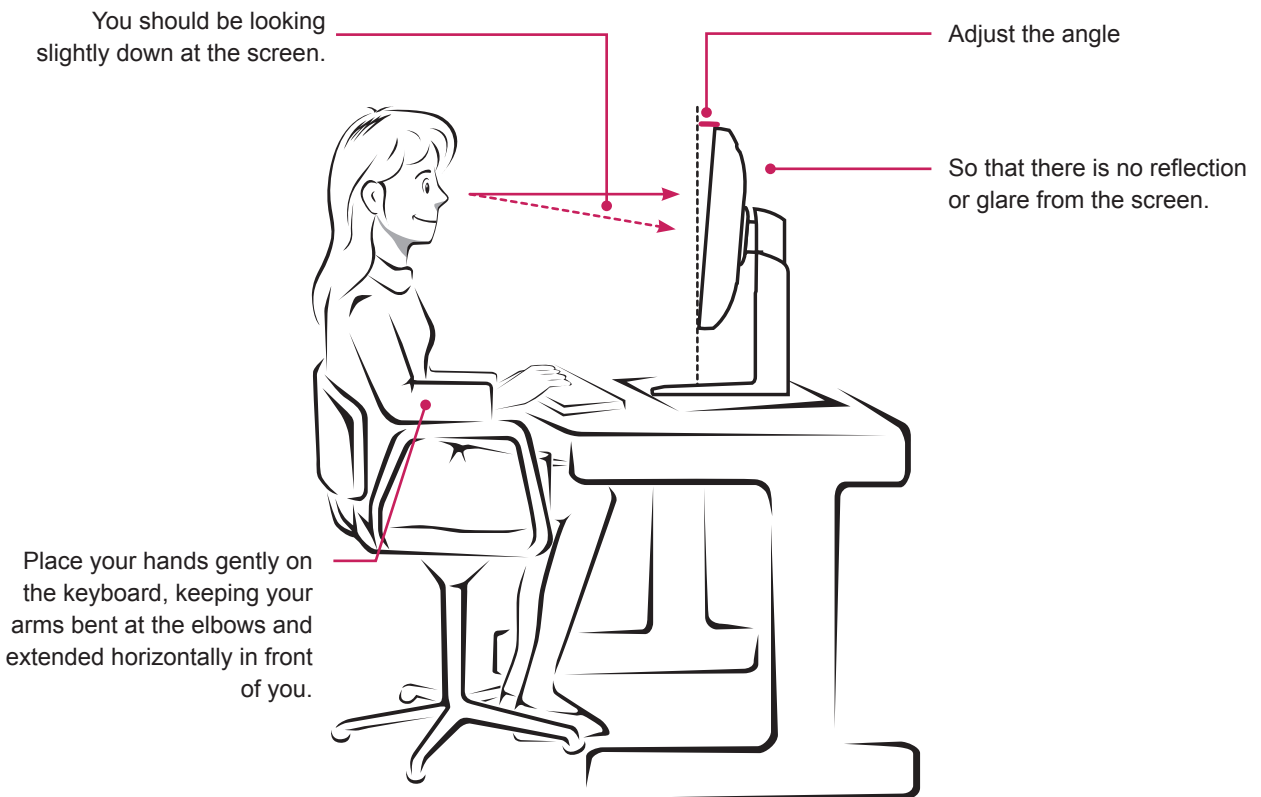



**Declaration of Conformity**

Trade Name: LG

Model : 25UM57,29UM57

Responsible Party: LG Electronics Inc.

Address : 1000 Sylvan Ave. Englewood Cliffs

NJ 07632 U.S.A

TEL: 201-266-2534

\*above information is only for USA FCC Regulatory

**Make sure to read the Safety Precautions before using the product.**

**Keep the Owner's Manual(CD) in an accessible place for future reference.**

The model and serial number of the SET is located on the back and one side of the SET. Record it below should you ever need service.

MODEL \_\_\_\_\_

SERIAL \_\_\_\_\_

ENERGY STAR is a set of power-saving guidelines issued by the U.S.Environmental Protection Agency (EPA).



As an ENERGY STAR Partner LGE USA, Inc. has determined that this product meets the ENERGY STAR guidelines for energy efficiency.

Refer to [ENERGY STAR.gov](http://ENERGY STAR.gov) for more information on the ENERGY STAR program.