

SVEN®
YOU WANT – WE CAN

2.0 Multimedia Speaker System

OPERATION MANUAL



SPS-610

www.sven.fi

Congratulations on your purchase of the Sven speaker system!

COPYRIGHT

© 2014. SVEN PTE. LTD. Version 1.0 (V 1.0).

This Manual and information contained in it are copyrighted. All rights reserved.

TRADEMARKS

All trademarks are the property of their legal holders.

NOTICE OF RESPONSIBILITY RESTRICTION

Despite the exerted efforts to make this Manual more exact, some discrepancies may occur. The information in this Manual is given on “as is” terms. The author and the publisher do not bear any liability to a person or an organization for loss or damage which has arisen from the information contained in this Manual.

CONTENTS

1. BUYER RECOMMENDATIONS	1
2. PACKAGE CONTENTS.....	2
3. SAFETY PRECAUTIONS	2
4. TECHNICAL DESCRIPTION	2
5. PREPARATION AND OPERATION	3
6. TROUBLESHOOTING.....	4
7. TECHNICAL SPECIFICATIONS	5

1. BUYER RECOMMENDATIONS

- Unpack the device carefully. Make sure there are no accessories left in the box. Check up the device for damage; if the product was damaged during transportation, address the firm which carried out the delivery; if the product functions incorrectly, address the dealer at once.
- Check up the package contents and availability of the warranty card. Make sure the warranty card has a shop stamp, a legible signature or the seller’s stamp and purchase date, and the goods number corresponds to that in the warranty card. Remember: in case of warranty card loss or discrepancy of numbers you forfeit the right for warranty repairs.
- Do not switch on the speaker system immediately after you bring it into a room from environment with negative temperature! After unpacking, the speaker system should be kept in conditions of room temperature for at least 4 hours.
- Before installing and using the speaker system, read this Manual carefully and keep it for future reference.

Technical support is on www.sven.fi.

2. PACKAGE CONTENTS

- Speakers — 2 pcs
- 2RCA to mini-jack signal cable — 1 pc
- Audio cable — 1 pc
- Operation manual — 1 pc
- Warranty card — 1 pc

3. SAFETY PRECAUTIONS



Caution! High voltage inside! To avoid the risk of electric shock do not open or touch elements inside.

- To avoid electric shock, do not open the MSS and do not perform repairs by yourself. Service and repairs should be performed only by qualified specialists in an authorized service center. The list of authorized service centers is available on www.sven.fi.
- Do not allow the circuit of wires (including the grounded ones) between the speakers, on the power amplifier or the ground, for it causes damage to the power amplifier output stage.
- Do not touch the MSS power cord plug pins for 2 seconds after unplugging it from the mains.
- Disconnect MSS from the mains system during a fuse replacement. Use fuses of the same type and rated value. Do not use hand-made fuses.
- Do not put foreign objects inside the holes of the MSS.
- Protect the MSS from high humidity, water and dust.
- Protect the MSS from heating; do not place it closer than 1 m from a heat source. Do not expose it to direct sunlight.
- Do not place any open flame sources on or close to MSS.
- Do not place the MSS in poorly ventilated areas. Leave an air gap of 10 cm or more. When operating the MSS, do not put any devices on it, do not cover it with cloth or other objects preventing it from cooling.
- Do not use any chemical agents for cleaning. Clean it with dry soft cloth only.







4. TECHNICAL DESCRIPTION

SPS-610 2.0 Multimedia Speaker System (MSS) is designed to play music and sound games, movies, etc. The MSS has a built-in power amplifier allowing to connect it to virtually any audio source (CD/DVD-player, TV, PC, etc.) without using an additional power amplifier. One speaker is active (it has a built-in power amplifier and a control panel), the other one is passive. The MSS can be connected to an active subwoofer.

Special features

- Speaker system is compatible with PCs, DVD/Media-players, mobile devices and other sound sources
- Built-in transformer power supply
- Control knobs on the front control panel
- Soft timbre control
- Headphone jack
- Magnetic shielding
- MDF speaker cabinets

Active speaker front side

- ① : headphone jack
- ② : Power LED
- ③ : TREBLE: treble control knob
- ④ : BASS: bass control knob
- ⑤ : VOLUME: volume control knob
- ⑥ : POWER ON/OFF: power switch

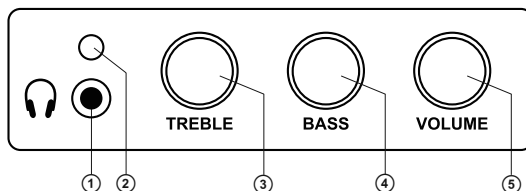

Fig. 1. Control panel

5. PREPARATION AND OPERATION**Speaker placement**

- Place the speakers symmetrically to the listeners at least one meter away.
- The bass reflex port is located on the back panel of the speaker cabinet, please locate the speakers 20–30 cm away from the wall or any other object.
- Place MSS far away from monitors and TV sets, as insignificant image distortion in these supersensitive devices is possible.

MSS Connecting

SPS-610 Multimedia Speaker System can be connected to virtually any audio source: DVD/CD, PC sound card, etc. (see Fig. 2).

- Before making any connections, be sure that all components are switched off.
- Connect the speakers with the audio cable.
- Plug the RCA connectors of the included 2RCA to 3.5 mm mini-jack stereo signal cable into the INPUT R/L jacks of the MSS, and connect the mini-jack of the signal cable to the output jack of your PC sound card or to the audio output (Ø 3.5 mm jack) of any other sound source, as shown in Fig. 2.

Note. To connect the MSS to a CD/DVD/MP3 player or TV, use a 2RCA to 3.5 mm mini-jack stereo signal cable (included) with a mini-jack to 2RCA adapter (not included), as shown in Fig. 2 or use a 2RCA to 2RCA stereo signal cable (not included).

- Plug the power cord into the mains socket.
- Adjust the VOLUME ⑤ knob to the minimum; switch on the power supply with the power button ⑥ on the side of the active speaker. The power LED ② lights up.
- Adjust the volume knob ⑤ to the necessary volume.
- Adjust the TREBLE ③ and BASS ④ knobs as desired.
- Connect your headphones to the headphone jack ① (see Fig. 1).

Notes:

- After using the MSS, mind to shift the POWER switch on the rear panel of the active speaker into the OFF position, and unplug the power cord.
- To enhance the sound quality, use the Line-Out port of your sound card.

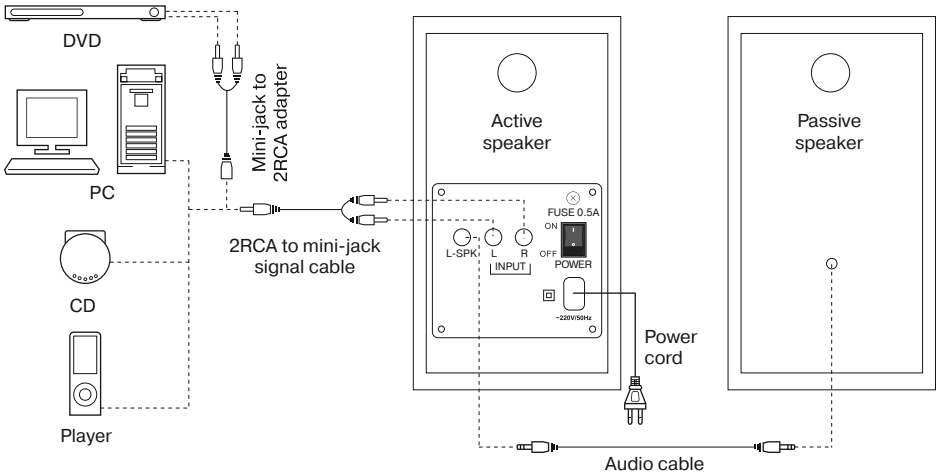

Fig. 2. Connection diagram

6. TROUBLESHOOTING

Problem	Cause	Solution
The MSS does not turn on.	The MSS isn't connected to a mains outlet.	Check the connection.
	The power switch is off.	Turn on the switch.
No sound.	The volume level is set at minimum value.	Adjust the volume control knob.
	Improperly connected audio source.	Connect audio sources correctly.
There is too quiet sound of speakers.	Volume level is set at minimum value.	Adjust the volume control knob.
Distortion of sound.	Large amplitude of the input signal.	Turn down the source volume and the MSS volume.

If none of the above methods can solve the problem, please seek professional advice at your nearest service center. Never attempt to repair the product yourself.

7. TECHNICAL SPECIFICATIONS

Parameter, measurement unit	Value
Output power (RMS), W	20 (2 × 10)
Frequency range, Hz	40 – 20,000
Impedance, Ohm	4
Speaker diameter, mm woofer tweeter	Ø 100 Ø 19
Magnetic shielding	yes
Voltage supply, V/Hz	~220/50
Dimensions (one speaker) (W × H × D), mm	145 × 246 × 160
Weight, kg	3.8

Notes:

- *Technical specifications given in this table are supplemental information and cannot give occasion to claims.*
- *Technical specifications and package contents are subject to change without notice due to the improvement of SVEN production.*

2.0 Multimedia Speaker System

SVEN®
YOU WANT – WE CAN



Модель: SPS-610

Импортер в России: ООО «СКАНДИТРЕЛ», 111024, РФ,
г. Москва, ул. Авиамоторная, д. 65, стр. 1.

Уполномоченная организация в России: ООО «РТ-Ф»,
105082, г. Москва, ул. Фридриха Энгельса, д. 75, стр. 5.

Условия гарантийного обслуживания смотрите
в гарантийном талоне или на сайте **www.sven.fi**.

Гарантийный срок: 12 мес.

Срок службы: 5 лет.

Производитель: «СВЕН ПТЕ. Лимитед»,
176 Джу Чиаг Роуд, № 02-02, Сингапур, 427447.

Произведено под контролем «Свен Скандинавия
Лимитед», 48310, Финляндия, Котка,
Котлахдентие, 15. Сделано в Китае.

Manufacturer: SVEN PTE. LTD, 176 Joo Chiat Road,
№ 02-02, Singapore, 427447. Produced under the
control of Oy Sven Scandinavia Ltd, 15, Kotolahdentie,
Kotka, Finland, 48310. Made in China.

© **Registered Trademark of Oy SVEN**
Scandinavia Ltd. Finland.

SPS-610