

User Guide



HP Officejet 6600



HP Officejet 6600 e-All-in-One series

User Guide

Copyright information

© 2014 Copyright Hewlett-Packard Development Company, L.P.
Edition 2, 1/2014

Hewlett-Packard Company notices

The information contained in this document is subject to change without notice.

All rights reserved. Reproduction, adaptation, or translation of this material is prohibited without prior written permission of Hewlett-Packard, except as allowed under copyright laws.

The only warranties for HP products and services are set forth in the express warranty statements accompanying such products and services. Nothing herein should be construed as constituting an additional warranty. HP shall not be liable for technical or editorial errors or omissions contained herein.

Acknowledgements

Windows, Windows XP, and Windows Vista are U.S. registered trademarks of Microsoft Corporation.

ENERGY STAR and the ENERGY STAR mark are registered U.S. marks.

Safety information



Always follow basic safety precautions when using this product to reduce risk of injury from fire or electric shock.

1. Read and understand all instructions in the documentation that comes with the printer.
2. Observe all warnings and instructions marked on the product.
3. Unplug this product from wall outlets before cleaning.
4. Do not install or use this product near water, or when you are wet.
5. Install the product securely on a stable surface.
6. Install the product in a protected location where no one can step on or trip over the line cord, and the line cord cannot be damaged.
7. If the product does not operate normally, see [Solve a problem](#).
8. There are no user-serviceable parts inside. Refer servicing to qualified service personnel.

Accessibility

The printer provides a number of features that make it accessible for people with disabilities.

Visual

The printer software is accessible for those with visual impairments or low vision through the use of your operating system's accessibility options and features. It also supports most assistive technology such as screen readers, Braille readers, and voice-to-text applications. For those who are color blind, colored buttons and tabs used in the software and on the printer control panel have simple text or icon labels that convey the appropriate action.

Mobility

For those with mobility impairments, the printer software functions can be executed through keyboard commands. The software also supports Windows accessibility options such as StickyKeys, ToggleKeys, FilterKeys, and MouseKeys. The printer doors, buttons, paper trays, and paper guides can be operated by those with limited strength and reach.

Support

For more details about the accessibility of this product and HP's commitment to product accessibility, visit HP's web site at www.hp.com/accessibility.

For accessibility information for Mac OS X, visit the Apple web site at www.apple.com/accessibility.

Contents

1 Get started

Accessibility.....	9
Eco.....	10
Understand the printer parts.....	11
Front view.....	11
Printing supplies area.....	11
Back view.....	12
Use the printer control panel.....	12
Overview of buttons and lights.....	12
Control panel display icons.....	13
Change printer settings.....	14
Select the mode.....	14
To select a different mode.....	14
To change settings for a mode.....	14
Change the printer settings.....	15
Find the printer model number.....	15
HP Digital Solutions.....	15
Scan to Computer.....	15
HP Digital Fax (Fax to PC and Fax to Mac).....	15
Select print media.....	15
Recommended papers for printing and copying.....	16
Recommended papers for photo printing.....	17
Tips for selecting and using media.....	18
Load an original on the scanner glass.....	18
Load an original in the automatic document feeder (ADF).....	19
Load media.....	20
Load standard-size media.....	20
Load envelopes.....	21
Load cards and photo paper.....	22
Load custom-size media.....	23
Maintain the printer.....	24
Clean the scanner glass.....	24
Clean the exterior.....	24
Clean the automatic document feeder.....	25
Update the printer.....	25
Turn off the printer.....	26

2 Print

Print documents.....	27
Print documents (Windows).....	28
Print documents (Mac OS X).....	28
Print brochures.....	28
Print brochures (Windows).....	29
Print brochures (Mac OS X).....	29

Print on envelopes.....	29
Print on envelopes (Windows).....	30
Print on envelopes (Mac OS X).....	30
Print photos.....	31
Print photos on photo paper (Windows).....	31
Print photos on photo paper (Mac OS X).....	32
Print on special and custom-size paper.....	32
Print on special or custom-size paper (Mac OS X).....	33
Print borderless documents.....	34
Print borderless documents (Windows).....	34
Print borderless documents (Mac OS X).....	34
3 Scan	
Scan an original.....	36
Scan to a computer.....	36
Scan using Webscan.....	37
Scanning documents as editable text.....	38
To scan documents as editable text.....	38
Guidelines for scanning documents as editable text.....	39
4 Copy	
Copy documents.....	41
Change copy settings.....	41
5 Fax	
Send a fax.....	43
Send a standard fax.....	43
Send a standard fax from the computer.....	44
Send a fax manually from a phone.....	45
Send a fax using monitor dialing.....	46
Send a fax from memory.....	47
Schedule a fax to send later.....	47
Send a fax to multiple recipients.....	48
Send a fax in Error Correction Mode.....	48
Receive a fax.....	49
Receive a fax manually.....	49
Set up backup fax.....	50
Reprint received faxes from memory.....	50
Poll to receive a fax.....	51
Forward faxes to another number.....	51
Set the paper size for received faxes.....	52
Set automatic reduction for incoming faxes.....	52
Block unwanted fax numbers.....	52
Add numbers to the junk fax list.....	53
Remove numbers from the junk fax list.....	53
Print a Junk Fax Report.....	54
Receive faxes to your computer using HP Digital Fax (Fax to PC and Fax to Mac).....	54
Fax to PC and Fax to Mac requirements.....	54
Activate Fax to PC and Fax to Mac.....	55
Modify Fax to PC and Fax to Mac settings.....	55

Set up speed-dial entries.....	56
Set up and change speed-dial entries.....	56
Set up and change group speed-dial entries.....	57
Delete speed-dial entries.....	57
Print a list of speed-dial entries.....	58
Change fax settings.....	58
Configure the fax header.....	58
Set the answer mode (Auto answer).....	58
Set the number of rings before answering.....	59
Change the answer ring pattern for distinctive ring.....	59
Set the dial type.....	60
Set the redial options.....	60
Set the fax speed.....	61
Set the fax sound volume.....	61
Fax and digital phone services.....	62
Fax over Internet Protocol.....	62
Use reports.....	63
Print fax confirmation reports.....	63
Print fax error reports.....	64
Print and view the fax log.....	64
Clear the fax log.....	64
Print the details of the last fax transaction.....	65
Print a Caller ID Report.....	65
View the Call History.....	65
6 Web Services	
What are Web Services?.....	66
HP ePrint.....	66
Printer Apps.....	66
Set up Web Services.....	67
Set up Web Services using the HP printer software	67
Set up Web Services using the printer's control panel.....	67
Set up Web Services using the embedded web server.....	68
Use Web Services.....	68
HP ePrint.....	68
Print using HP ePrint.....	68
Find the printer's email address.....	69
Turn off HP ePrint.....	69
Printer Apps.....	69
Use Printer Apps.....	69
Manage Printer Apps.....	69
Turn off Printer Apps.....	69
Remove Web Services.....	70
7 Work with ink cartridges	
Information on ink cartridges and the printhead.....	71
Check the estimated ink levels.....	72
Printing with black or color ink only.....	72
Replace the ink cartridges.....	73
Store printing supplies.....	74
Usage information collection.....	74

8 Solve a problem

HP support.....	76
Obtain electronic support.....	77
HP support by phone.....	77
Before you call.....	77
Phone support period.....	78
Telephone support numbers.....	78
After the phone support period.....	80
General troubleshooting tips and resources.....	80
Solve printer problems.....	80
The printer shuts down unexpectedly.....	81
The printer is making some unexpected noises.....	81
Alignment fails.....	81
The printer is not responding (nothing prints).....	81
The printer prints slowly.....	82
Blank or partial page printed.....	83
Something on the page is missing or incorrect.....	83
Placement of the text or graphics is wrong.....	84
Print quality troubleshooting.....	85
Solve paper-feed problems.....	91
Solve copy problems.....	92
No copy came out.....	92
Copies are blank.....	93
Documents are missing or faded.....	93
Size is reduced.....	93
Copy quality is poor.....	94
Copy defects are apparent.....	94
The printer prints half a page, then ejects the paper.....	95
Paper mismatch.....	95
Solve scan problems.....	95
Scanner did nothing.....	95
Scan takes too long.....	96
Part of the document did not scan or text is missing.....	96
Text cannot be edited.....	96
Error messages appear.....	97
Scanned image quality is poor.....	97
Scan defects are apparent.....	99
Solve fax problems.....	99
The fax test failed.....	100
Solve problems using Web Services and HP websites.....	112
Solve problems using Web Services.....	113
Solve problems using HP websites.....	113

Contents

Solve wireless problems.....	114
Basic wireless troubleshooting.....	114
Advanced wireless troubleshooting.....	115
Step 1: Make sure your computer is connected to your network.....	115
Step 2: Make sure that the printer is connected to your network.....	116
Step 3: Check to see if the firewall software is blocking communication.....	117
Step 4: Make sure the printer is online and ready.....	117
Step 5: Make sure the wireless version of the printer is set as the default printer driver (Windows only).....	118
Step 6: Make sure your computer is not connected to your network over a Virtual Private Network (VPN).....	118
After resolving the problems	119
Configure your firewall software to work with the printer.....	119
Solve printer management problems.....	120
Embedded web server cannot be opened.....	120
Troubleshoot installation issues.....	121
Hardware installation suggestions.....	122
HP software installation suggestions.....	122
Solve network problems.....	123
Understand the Printer Status Report.....	123
Understand the network configuration page.....	124
Clear jams.....	126
Clear paper jams.....	126
Avoid paper jams.....	128
A Technical information	
Warranty information.....	130
Hewlett-Packard limited warranty statement.....	131
Ink cartridge warranty information.....	132
Printer specifications.....	133
Physical specifications.....	133
Product features and capacities.....	133
Processor and memory specifications.....	134
System requirements.....	134
Network protocol specifications.....	134
Embedded web server specifications.....	135
Media specifications.....	135
Understand specifications for supported media.....	135
Set minimum margins.....	138
Print specifications.....	139
Copy specifications.....	139
Fax specifications.....	139
Scan specifications.....	140
Web Services specifications.....	140
HP ePrint.....	140
Printer Apps.....	140
HP website specifications.....	140
Environmental specifications.....	140
Electrical specifications.....	141
Acoustic emission specifications.....	141

Regulatory information.....	142
Regulatory Model Number.....	142
FCC statement.....	143
Notice to users in Korea.....	143
VCCI (Class B) compliance statement for users in Japan.....	143
Notice to users in Japan about the power cord.....	144
Noise emission statement for Germany.....	144
LED indicator statement.....	144
Gloss of housing of peripheral devices for Germany.....	144
Notice to users of the U.S. telephone network: FCC requirements.....	145
Notice to users of the Canadian telephone network.....	146
Notice to users of the German telephone network.....	146
Australia wired fax statement.....	146
European Union Regulatory Notice.....	146
Products with external AC Adapters.....	147
Products with wireless functionality.....	147
European telephone network declaration (Modem/Fax).....	147
Regulatory information for wireless products.....	147
Exposure to radio frequency radiation.....	147
Notice to users in Brazil.....	148
Notice to users in Canada.....	148
Notice to users in Taiwan.....	148
Environmental product stewardship program.....	149
Paper use.....	149
Plastics.....	149
Material safety data sheets.....	149
Recycling program.....	149
HP inkjet supplies recycling program.....	149
Disposal of waste equipment by users.....	150
Power consumption.....	150
Chemical Substances.....	150
Battery disposal in Taiwan.....	150
Battery Notice for Brazil.....	151
Disposal of Waste Electronic Equipment in Brazil.....	151
Attention California users.....	151
EU battery directive.....	152
RoHS notices (China only).....	152
RoHS notices (Ukraine only).....	153
Restriction of hazardous substance (India).....	153
Third-party licenses.....	154

B HP supplies and accessories

Order printing supplies online.....	162
Supplies.....	162
Ink cartridges.....	162
HP media.....	163

C Additional fax setup

Set up faxing (parallel phone systems).....164

 Select the correct fax setup for your home or office.....165

 Case A: Separate fax line (no voice calls received).....167

 Case B: Set up the printer with DSL.....168

 Case C: Set up the printer with a PBX phone system or an ISDN line.....169

 Case D: Fax with a distinctive ring service on the same line.....170

 Case E: Shared voice/fax line.....171

 Case F: Shared voice/fax line with voice mail.....172

 Case G: Fax line shared with computer modem (no voice calls received).....173

 Set up the printer with a computer dial-up modem.....173

 Set up the printer with a computer DSL/ADSL modem.....174

 Case H: Shared voice/fax line with computer modem.....175

 Shared voice/fax with computer dial-up modem.....176

 Shared voice/fax with computer DSL/ADSL modem.....178

 Case I: Shared voice/fax line with answering machine.....179

 Case J: Shared voice/fax line with computer modem and answering machine.....180

 Shared voice/fax line with computer dial-up modem and answering machine.....181

 Shared voice/fax line with computer DSL/ADSL modem and answering machine....183

 Case K: Shared voice/fax line with computer dial-up modem and voice mail.....184

Serial-type fax setup.....186

Test fax setup.....187

D Network setup

Set up the printer for wireless communication.....188

 Before you begin.....188

 Set up the printer on your wireless network.....189

 Set up the printer using the HP printer software (Recommended).....189

 Set up the printer using the Wireless Setup Wizard.....189

 Set up the printer using WiFi Protected Setup (WPS).....189

 To connect the printer using the Push Button Method.....190

 To connect the printer using the PIN Method.....190

 Set up the printer using the embedded web server (EWS).....190

 Change the connection type.....190

 Test the wireless connection.....191

 Guidelines for ensuring wireless network security.....191

 Overview of security settings.....191

 Add hardware addresses to a wireless router (MAC filtering).....191

 Other wireless security guidelines.....192

 Guidelines for reducing interference on a wireless network.....192

Change basic network settings.....192

 View and print network settings.....193

 Turn the wireless radio on and off.....193

Change advanced network settings.....193

 Set link speed.....193

 View IP settings.....193

 Change IP settings.....193

 Reset network settings.....194

Uninstall and reinstall the HP software.....194

E	Printer management tools	
	Toolbox (Windows).....	195
	HP Utility (Mac OS X).....	195
	Embedded web server.....	195
	About cookies.....	195
	To open the embedded web server.....	196
	Index	205

1 Get started

This guide provides details about how to use the printer and how to resolve problems.

- [Accessibility](#)
- [Eco](#)
- [Understand the printer parts](#)
- [Use the printer control panel](#)
- [Find the printer model number](#)
- [HP Digital Solutions](#)
- [Select print media](#)
- [Load an original on the scanner glass](#)
- [Load an original in the automatic document feeder \(ADF\)](#)
- [Load media](#)
- [Maintain the printer](#)
- [Update the printer](#)
- [Turn off the printer](#)

 **NOTE:** If you are using the printer with a computer running Windows XP Starter Edition, Windows Vista Starter Edition, or Windows 7 Starter Edition, some features might not be available. For more information, see [System requirements](#).

Accessibility

The printer provides a number of features that make it accessible for people with disabilities.

Visual

The HP software provided with the printer is accessible for those with visual impairments or low vision by using your operating system's accessibility options and features. The software also supports most assistive technology such as screen readers, Braille readers, and voice-to-text applications. For those who are color blind, colored buttons and tabs used in the HP software and on the printer control panel have simple text or icon labels that convey the appropriate action.

Mobility

For those with mobility impairments, the HP software functions can be executed through keyboard commands. The HP software also supports Windows accessibility options such as StickyKeys, ToggleKeys, FilterKeys, and MouseKeys. The printer doors, buttons, paper trays, and paper guides can be operated by those with limited strength and reach.

Support

For more details about the accessibility of this printer and HP's commitment to product accessibility, visit HP's web site at www.hp.com/accessibility.

For accessibility information for Mac OS X, visit the Apple web site at www.apple.com/accessibility.

Eco



Hewlett-Packard is committed to providing quality products in an environmentally sound manner. Design for recycling has been incorporated into this product. For more information, see [Environmental product stewardship program](#).

HP is committed to helping customers reduce their environmental footprint. HP has provided these features to help you focus on ways to assess and reduce the impact of your printing choices.

For more information about HP's environmental initiatives, visit www.hp.com/hpinfo/globalcitizenship/environment/

Manage Power

To conserve electricity, try the following:

- Turn on the printer's Sleep Mode feature, and then select the option for the shortest time. After the printer has been inactive for this period of time, the printer will go into low-power mode. To configure this feature, touch  (eco button) on the printer's control panel display, touch **Sleep**, and then touch the desired option.
- Use the printer's Schedule On and Off feature, and then select the days and time you want the printer to turn on and turn off automatically. For example, you can schedule the printer to turn on at 8am and turn off at 8pm from Monday to Friday. In this way, you will save energy during the night and weekends. To configure this feature, touch  (eco button) on the printer's control panel display, touch **Schedule On and Off**, and then set the time to turn on and off the printer.
- Adjust the screen brightness to a dimmer setting. To configure this feature, touch  (eco button) on the printer's control panel display, touch **Screen Brightness**, and then set the desired option.

 **NOTE:** The printer's Sleep Mode and Schedule On and Off features are temporarily not available if one or more of the ink cartridges are missing. After the cartridge is reinstalled, these features resume.

 **CAUTION:** HP recommends that you replace any missing cartridges as soon as possible to avoid print quality issues and possible extra ink usage or damage to the ink system. Never turn off the printer when ink cartridges are missing.

Conserve Printing Supplies

To conserve printing supplies such as ink and paper, try the following:

- Change the print mode to a draft setting. Draft setting uses less ink.
- Do not clean the printhead unnecessarily. This wastes ink and shortens the life of the cartridges.
- Reduce paper usage by printing on both sides of the paper. You can first print just the odd pages, flip the pages over, and then print just the even pages.

Understand the printer parts

This section contains the following topics:

- [Front view](#)
- [Printing supplies area](#)
- [Back view](#)

Front view

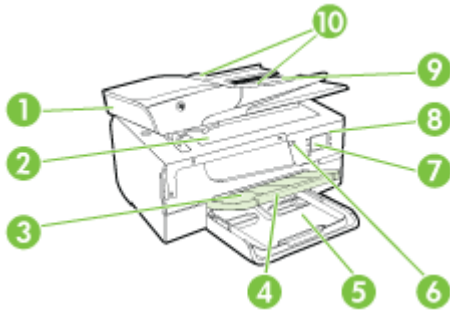

1	Automatic document feeder (ADF)
2	Scanner glass
3	Output tray
4	Output tray extension
5	Input tray
6	Power button
7	Control panel display
8	Control panel
9	Document feeder tray
10	Width guides

Printing supplies area

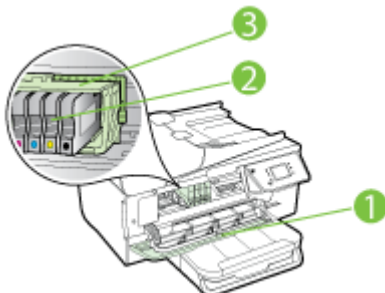

1	Ink cartridge access door
2	Ink cartridges
3	Printhead

 **NOTE:** Printing supplies should be kept in the printer to prevent possible print quality issues or printhead damage. Avoid removing supplies for extended periods of time. Do not turn off the printer when a cartridge is missing.

Back view

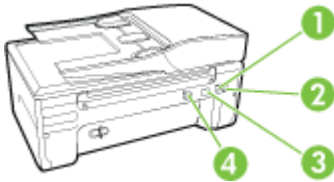

1	Fax port (1-LINE)
2	Fax port (2-EXT)
3	Power input
4	Universal serial bus (USB) port

Use the printer control panel

This section contains the following topics:

- [Overview of buttons and lights](#)
- [Control panel display icons](#)
- [Change printer settings](#)





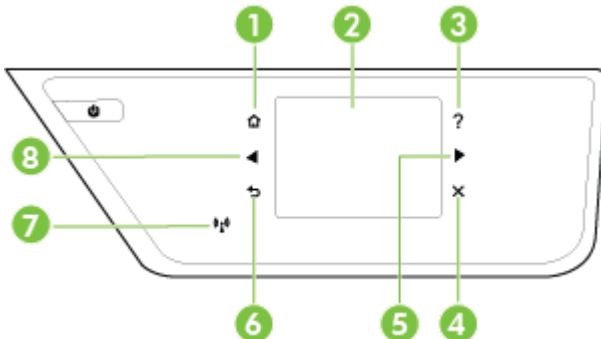





Overview of buttons and lights



The following diagrams and related tables provide a quick reference to the printer control panel features.



Label	Name and Description
1	Home button: Returns to the home screen from any other screen.
2	Control panel display: Touch the screen to select menu options. For information about the icons that appear on the display, see Control panel display icons .
3	Help button: Opens the Help menu.
4	Cancel button: Stops a job, exits a menu, or exits settings.
5	Right arrow button: Navigates through settings in the menus.
6	Back button: Returns to the previous menu.
7	Wireless light: The light is on when the 802.11 wireless feature is on.
8	Left arrow button: Navigates through settings in the menus.

Control panel display icons

Icon	Purpose
	Shows that a wireless network connection exists. The signal strength is indicated by the number of curved lines. This is for infrastructure mode. For more information, see Set up the printer for wireless communication .
	Displays a screen where you can learn about printer features that help conserve natural resources and reduce the environmental impact of your printing choices. TIP: You can configure settings for some features from this screen.
	Shows that HP ePrint is turned on. For more information, see HP ePrint .
	Displays a screen where you can make copies or select other options.
	Displays a screen where you can send a fax, or choose fax settings.
	Displays a screen where you can make a scan, or change scan settings.
	Displays a screen where you can use HP Apps.
	Displays a screen where you can adjust photo printing options.
	Displays the Setup screen for generating reports, changing fax and other maintenance settings, and accessing the Help screen.
	Provides more information about the printer's features.

Icon	Purpose
	<p>Displays a screen where you can see information about the ink cartridges, including fill levels. This icon has a red border when an ink cartridge needs attention.</p> <p>NOTE: Ink level warnings and indicators provide estimates for planning purposes only. When you receive a low-ink warning message, consider having a replacement cartridge available to avoid possible printing delays. You do not need to replace cartridges until prompted to do so.</p>
	<p>Displays the status of the Auto Answer function. Touch Auto Answer to turn it on or off. For more information, see Set the answer mode (Auto answer).</p>

Change printer settings

Use the control panel to change the printer mode and settings, print reports, or get help for the printer.



 **TIP:** If the printer is connected to a computer, you can also change the printer settings using HP software tools available on your computer, such as the HP printer software, HP Utility (Mac OS X), or the EWS. For more information about these tools, see [Printer management tools](#).

This section contains the following topics:



- [Select the mode](#)
- [To select a different mode](#)
- [To change settings for a mode](#)
- [Change the printer settings](#)

Select the mode

The main menu of the control panel display shows the available modes for the printer.

To select a mode, touch  (left arrow) or  (right arrow) to see the available modes, and then touch the icon to select the desired mode. Follow the prompts on the control panel display to complete the job. The control panel display returns to the main menu when the job is finished.

To select a different mode

Touch  (Back button) to return to the main menu. Touch  (left arrow) or  (right arrow) to scroll through the available modes, and then touch the icon to select the desired mode.

To change settings for a mode



1. After selecting a mode, touch the arrow buttons to scroll through the available settings, and then touch the setting you want to change.
2. Follow the prompts on the display to change the settings, and then touch **Done**.

 **NOTE:** Touch  (Back button) to return to the previous menu.

Change the printer settings

To change the printer settings or print reports, use the options available in the Setup screen:

1. Touch  (right arrow), and then touch **Setup**.
2. Touch the arrows to scroll through the screens.
3. Touch the screen items to select screens or options.

 **NOTE:** Use the  (Back) button to return to the previous menu.

Find the printer model number

In addition to the model name that appears on the front of the printer, this printer has a specific model number. You can use this number when obtaining support and to help determine which supplies or accessories are available for your printer.

The model number is printed on a label located on the inside of the ink-cartridge access door, near the ink cartridges area.

HP Digital Solutions

The printer includes a collection of digital solutions that can help you simplify and streamline your work.

Scan to Computer

You can simply walk up to the printer, touch a button on the control panel, and either scan documents directly to a computer or quickly share them with business partners as e-mail attachments.

For more information, see [Scan](#).

HP Digital Fax (Fax to PC and Fax to Mac)

Never lose important faxes misplaced within a stack of paper pages again!

Use Fax to PC and Fax to Mac to automatically receive faxes and save faxes directly to your computer. With Fax to PC and Fax to Mac, you can store digital copies of your faxes easily and eliminate the hassle of dealing with bulky paper files. In addition, you can turn off fax printing altogether, saving money on paper and ink, and reduce paper consumption and waste.

For more information, see [Receive faxes to your computer using HP Digital Fax \(Fax to PC and Fax to Mac\)](#).

Select print media

The printer is designed to work well with most types of office media. It is best to test a variety of print media types before buying large quantities. Use HP media for

optimum print quality. Visit the HP web site at www.hp.com for more information about HP media.

	<p>HP recommends plain papers with the ColorLok logo for printing and copying of everyday documents. All papers with the ColorLok logo are independently tested to meet high standards of reliability and print quality, and produce documents with crisp, vivid color, bolder blacks and dry faster than ordinary plain papers. Look for papers with the ColorLok logo in a variety of weights and sizes from major paper manufacturers.</p>
---	---

This section contains the following topics:

- [Recommended papers for printing and copying](#)
- [Recommended papers for photo printing](#)
- [Tips for selecting and using media](#)

Recommended papers for printing and copying

If you want the best print quality, HP recommends using HP papers that are specifically designed for the type of project you are printing.

Depending on your country/region, some of these papers might not be available.

<p>HP Brochure Paper HP Professional Paper</p>	<p>These papers are glossy-coated or matte-coated on both sides for two-sided use. They are the perfect choice for producing professional quality marketing materials such as brochures and mailers, as well as business graphics for report covers and calendars.</p>
<p>HP Premium Presentation Paper HP Professional Paper</p>	<p>These papers are heavy two-sided matte papers perfect for presentation, proposals, reports, and newsletters. They are heavyweight for an impressive look and feel.</p>
<p>HP Bright White Inkjet Paper</p>	<p>HP Bright White Inkjet Paper delivers high-contrast colors and sharp text. It is opaque enough for two-sided color usage with no showthrough, which makes it ideal for newsletters, reports, and flyers. It features ColorLok Technology for less smearing, bolder blacks, and vivid colors.</p>
<p>HP Printing Paper</p>	<p>HP Printing Paper is a high-quality multifunction paper. It produces documents that look and feel more substantial than documents printed on standard multipurpose or copy paper. It features ColorLok Technology for less smearing, bolder blacks, and vivid colors.</p>
<p>HP Office Paper</p>	<p>HP Office Paper is a high-quality multifunction paper. It is suitable for copies, drafts, memos and other everyday documents. It features ColorLok Technology for less smearing, bolder blacks, and vivid colors.</p>
<p>HP Office Recycled Paper</p>	<p>HP Office Recycled Paper is a high-quality multifunction paper made with 30% recycled fiber. It features ColorLok Technology for less smearing, bolder blacks and vivid colors.</p>
<p>HP Premium Plus Photo Paper</p>	<p>HP's best photo paper is heavyweight for producing professional quality photos. Features an instant-dry finish for easy handling without smudging. It resists water, smears, fingerprints, and humidity. It is available in several sizes, including A4, 8.5 x 11 inch, 10 x 15 cm</p>

(continued)

	(4 x 6 inch), 13 x 18 cm (5 x 7 inch), and two finishes – glossy or soft-gloss (satin matte). It is acid-free for longer lasting documents.
HP Advanced Photo Paper	This thick photo paper features an instant-dry finish for easy handling without smudging. It resists water, smears, fingerprints, and humidity. Your prints have a look and feel comparable to a store processed photo. It is available in several sizes, including A4, 8.5 x 11 inch, 10 x 15 cm (4 x 6 inch), 13x18 cm (5 x7 inch), and two finishes – glossy or soft gloss (satin matte). It is acid-free for longer lasting documents.
HP Everyday Photo Paper	Print colorful, everyday snapshots at a low cost, using paper designed for casual photo printing. This affordable, photo paper dries quickly for easy handling. Get sharp, crisp images when you use this paper with any inkjet printer. Available in semi-gloss finish in 8.5 x 11 inch, A4, 4 x 6 inch and 10 x 15 cm. It is acid-free for longer lasting documents.
HP Iron-On Transfers	HP Iron-on Transfers (for color fabrics or for light or white fabrics) are the ideal solution for creating custom T-shirts from your digital photos.

To order HP papers and other supplies, go to www.hp.com. Go to **Shop for Products & Services**, and select **Ink, toner & paper**.

 **NOTE:** At this time, some portions of the HP web site are available in English only.

Recommended papers for photo printing

For the best print quality, HP recommends using HP papers that are specifically designed for the type of project you are printing. Depending on your country/region, some of these papers might not be available.

HP Premium Plus Photo Paper	HP's best photo paper is heavyweight for producing professional quality photos. Features an instant-dry finish for easy handling without smudging. It resists water, smears, fingerprints, and humidity. It is available in several sizes, including A4, 8.5 x 11 inch, 10 x 15 cm (4 x 6 inch), 13 x 18 cm (5 x 7 inch), and two finishes – glossy or soft-gloss (satin matte). It is acid-free for longer lasting documents.
HP Advanced Photo Paper	This thick photo paper features an instant-dry finish for easy handling without smudging. It resists water, smears, fingerprints, and humidity. Your prints have a look and feel comparable to a store processed photo. It is available in several sizes, including A4, 8.5 x 11 inch, 10 x 15 cm (4 x 6 inch), 13x18 cm (5 x7 inch), and two finishes – glossy or soft gloss (satin matte). It is acid-free for longer lasting documents.
HP Everyday Photo Paper	Print colorful, everyday snapshots at a low cost, using paper designed for casual photo printing. This affordable, photo paper dries quickly for easy handling. Get sharp, crisp images when you use this paper with any inkjet printer. Available in semi-gloss finish in 8.5 x 11 inch, A4, 4 x 6 inch, and 10 x 15 cm. It is acid-free for longer lasting documents.
HP Photo Value Packs	HP Photo Value Packs conveniently package original HP ink cartridges and HP Advanced Photo Paper to save you time and take the guesswork out of printing affordable, lab-quality photos with your HP printer. Original HP inks and HP Advanced Photo Paper have been designed to work together so your photos are long lasting and

(continued)

vivid, print after print. Great for printing out an entire vacation's worth of photos or multiple prints to share.

To order HP papers and other supplies, go to www.hp.com. Go to **Shop for Products & Services** and select **Ink, toner & paper**.

 **NOTE:** At this time, some portions of the HP web site are available in English only.

Tips for selecting and using media

For the best results, observe the following guidelines.

- Always use media that conforms to the printer specifications. For more information, see [Media specifications](#).
- Load only one type of media at a time into a tray or automatic document feeder (ADF).
- When loading the trays and ADF, make sure the media is loaded correctly. For more information, see [Load media](#) or [Load an original in the automatic document feeder \(ADF\)](#).
- Do not overload the tray or ADF. For more information, see [Load media](#) or [Load an original in the automatic document feeder \(ADF\)](#).
- To prevent jams, poor print quality, and other printing problems, avoid loading the following media in the trays or ADF:
 - Multipart forms
 - Media that is damaged, curled, or wrinkled
 - Media with cutouts or perforations
 - Media that is heavily textured, embossed, or does not accept ink well
 - Media that is too lightweight or stretches easily
 - Media that contains staples or clips

 **NOTE:** To scan, copy, or fax documents that contain pages that do not conform to these guidelines, use the scanner glass. For more information, see [Load an original on the scanner glass](#).

Load an original on the scanner glass

You can copy, scan, or fax originals by loading them on the scanner glass.

 **NOTE:** Many of the special features do not work correctly if the glass and lid backing are not clean. For more information, see [Maintain the printer](#).

To load an original on the scanner glass

Use these steps to load an original on the scanner glass.

1. Lift the scanner lid.
2. Load your original print-side down.

 **TIP:** For more help on loading an original, refer to the engraved guides along the edge of the glass.



3. Close the lid.

Load an original in the automatic document feeder (ADF)

You can copy, scan, or fax a document by placing it in the automatic document feeder (ADF).

 **CAUTION:** Do not load photos in the ADF; this might cause damage to your photos. Use only media that is supported by the printer. For more information, see [Tips for selecting and using media](#).

 **NOTE:** Only single-sided documents can be scanned, copied, or faxed using the ADF. The ADF does not support double-sided documents.

NOTE: Some features, such as the **Fit to Page** copy feature, do not work when you load your originals in the ADF. You must load your originals on the glass.

To load an original in the ADF

Use these steps to load a document in the ADF.

1. Load your original print-side up into the ADF.
 - a. If you are loading an original printed in portrait orientation, place the pages so that the top edge of the document goes in first. If you are loading an original printed in landscape orientation, place the pages so that the left edge of the document goes in first.
 - b. Slide the media into the ADF until you hear a tone or see a message on the display indicating that the loaded pages were detected.

 **TIP:** For more help on loading originals in the ADF, refer to the diagram engraved in the document feeder tray.

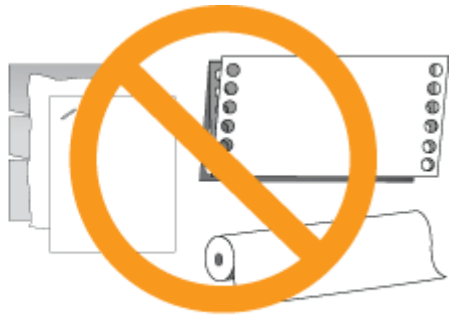

2. Slide the width guides inward until they stop at the left and right edges of the media.

 **NOTE:** Remove all originals from the document feeder tray before lifting the lid on the printer.

Load media

This section provides instructions for loading media into the printer.

This section contains the following topics:

- [Load standard-size media](#)
- [Load envelopes](#)
- [Load cards and photo paper](#)
- [Load custom-size media](#)

Load standard-size media

To load standard-size media

Use these instructions to load standard media.

1. Lift the output tray.
2. Slide the paper width guide out as far as possible.

3. Insert the media print-side down in the tray. Make sure the stack of media is inserted as far inside the printer as possible and does not exceed the line marking in the tray.

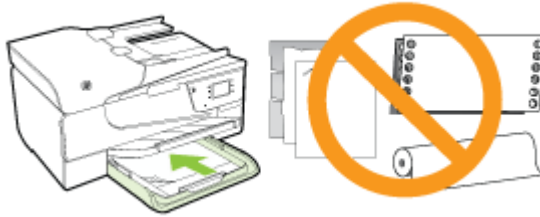

 **NOTE:** Do not load paper while the printer is printing.

4. Slide the media guides in the tray until they touch the edge of the stack of media.
5. Lower the output tray.
6. Pull out the tray extender.

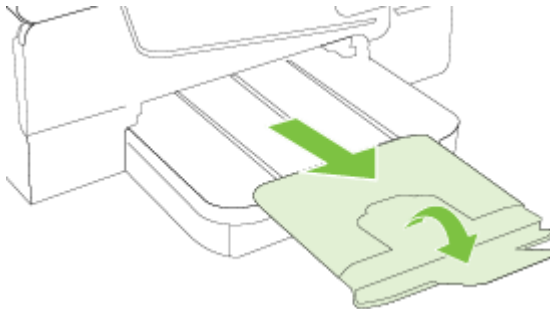

Load envelopes

To load envelopes

Use these instructions to load an envelope.

1. Lift the output tray.
2. Slide out the paper width guides in the input tray as far as possible.

3. Insert the envelopes print-side down and load according to the graphic. Make sure the stack of envelopes does not exceed the line marking in the tray.

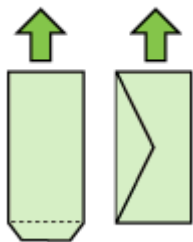

 **NOTE:** Do not load envelopes while the printer is printing.

4. Slide the media guides in the tray until they touch the edge of the stack of envelopes.
5. Lower the output tray.
6. Pull out the tray extender.

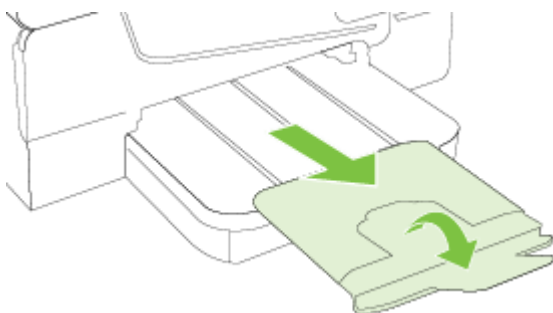

Load cards and photo paper

To load cards and photo paper

Use these instructions to load photo paper.

1. Lift the output tray.
2. Slide out the paper width guide in the input tray as far as possible.
3. Insert the media print-side down in the tray. Make sure the stack of media is inserted as far inside the printer as possible and does not exceed the line marking in the tray. If the photo paper has a tab along one edge, make sure the tab is pointing towards the front of the printer.

 **NOTE:** Do not load paper while the printer is printing.

4. Slide the media guides in the tray until they touch the edge of the stack of media.

5. Lower the output tray.
6. Pull out the tray extender.

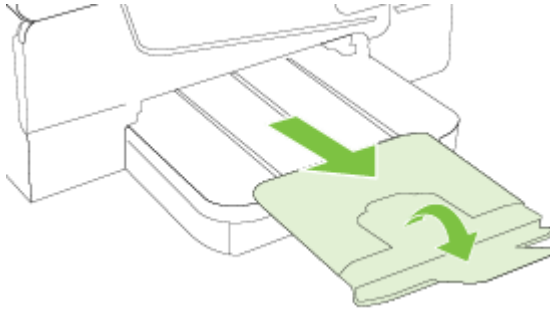

Load custom-size media

To load custom-size media

Use these instructions to load custom-size media.

⚠ CAUTION: Use only custom-size media that is supported by the printer. For more information, see [Media specifications](#).

1. Lift the output tray.
2. Slide the paper width guide out as far as possible.
3. Insert the media print-side down in the tray. Make sure the stack of media is inserted as far inside the printer as possible and does not exceed the line marking in the tray.

📄 NOTE: Do not load paper while the printer is printing.

4. Slide the media guides in the tray until they touch the edge of the stack of media.
5. Lower the output tray.
6. Pull out the tray extender.

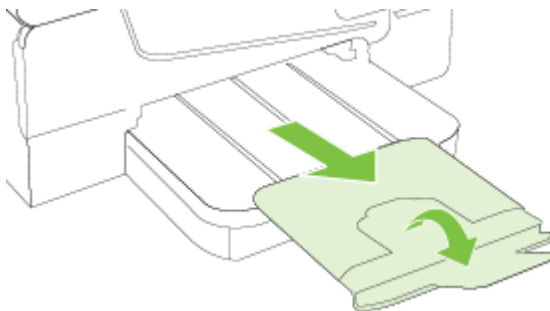

Maintain the printer

This section provides instructions for keeping the printer in top working condition. Perform these maintenance procedures as necessary.

- [Clean the scanner glass](#)
- [Clean the exterior](#)
- [Clean the automatic document feeder](#)

Clean the scanner glass

 **NOTE:** Dust or dirt on the scanner glass, scanner lid backing, or scanner frame can slow down performance, degrade the quality of scans, and affect the accuracy of special features such as fitting copies to a certain page size.

To clean the scanner glass

1. Turn off the printer. For more information, see [Turn off the printer](#).
2. Lift the scanner lid.
3. Clean the glass by using a soft, lint-free cloth that has been sprayed with a mild glass cleaner. Dry the glass with a dry, soft, lint-free cloth.

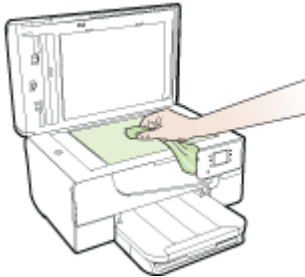



 **CAUTION:** Use only glass cleaner to clean the scanner glass. Avoid cleaners that contain abrasives, acetone, benzene, and carbon tetrachloride, all of which can damage the scanner glass. Avoid isopropyl alcohol because it can leave streaks on the glass.

CAUTION: Do not spray the glass cleaner directly on the glass. If too much glass cleaner is applied, the cleaner could leak under the glass and damage the scanner.

4. Close the scanner lid, and turn on the printer.

Clean the exterior

 **WARNING!** Before cleaning the printer, turn the printer off by pressing the  (Power button) and unplug the power cord from the electrical socket.

Use a soft, damp, lint-free cloth to wipe dust, smudges, and stains off of the case. Keep fluids away from the interior of the printer, as well as from the printer control panel.

Clean the automatic document feeder

If the automatic document feeder picks up multiple pages or if it does not pick up plain paper, you can clean the rollers and separator pad. Lift the automatic document feeder cover to access the pick assembly inside the automatic document feeder, clean the rollers or separator pad, and then close the cover.

To clean the rollers or separator pad

1. Remove all originals from the document feeder tray.
2. Lift the automatic document feeder cover (1).
This provides easy access to the rollers (2) and separator pad (3).

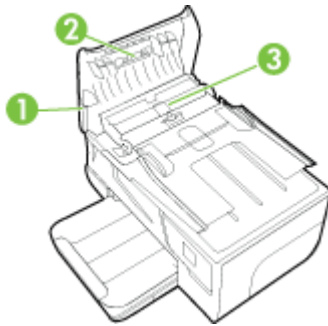

1	Automatic document feeder cover
2	Rollers
3	Separator pad

3. Lightly dampen a clean lint-free cloth with distilled water, then squeeze any excess liquid from the cloth.
4. Use the damp cloth to wipe any residue off the rollers or separator pad.

 **NOTE:** If the residue does not come off using distilled water, try using isopropyl (rubbing) alcohol.

5. Close the cover of the automatic document feeder.

Update the printer

HP is always working to improve the performance of its printers and bring you the latest features. If the printer is connected to a network and Web Services has been enabled, you can check for and install printer updates.

To update the printer, complete the following steps:

1. On the printer control panel, touch  (HP ePrint), touch **Settings**, and then touch **Product Updates**.
2. Touch **Check for Product Update**, and then follow the instructions on the display.

 **TIP:** To enable the printer to automatically check for updates, touch **Settings**, touch **Product Updates**, touch **Auto Update**, and then touch **Automatically**.

Turn off the printer

Turn the printer off by pressing  (Power) button located on the printer. Wait until the power light turns off before unplugging the power cord or turning off a power strip.







 **CAUTION:** If you incorrectly turn the printer off, the print carriage might not return to the correct position causing problems with the ink cartridges and print quality issues.

CAUTION: HP recommends that you replace any missing cartridges as soon as possible to avoid print quality issues and possible extra ink usage or damage to the ink system. Never turn off the printer when ink cartridges are missing.

2 Print

Most print settings are automatically handled by the software application. Change the settings manually only when you want to change print quality, print on specific types of paper, or use special features. For more information about selecting the best print media for your documents, see [Select print media](#).

Choose a print job to continue:

	Print documents
	Print brochures
	Print on envelopes
	Print photos
	Print on special and custom-size paper
	Print borderless documents

Print documents

Follow the instructions for your operating system.

- [Print documents \(Windows\)](#)
- [Print documents \(Mac OS X\)](#)

 **TIP:** This printer includes HP ePrint, a free service from HP that allows you to print documents on your HP ePrint-enabled printer anytime, from any location, without any additional software or printer drivers. For more information, see [HP ePrint](#).

Print documents (Windows)

1. Load paper in the tray. For more information, see [Load media](#).
2. On the **File** menu in your software application, click **Print**.
3. Make sure the printer you want to use is selected.
4. To change settings, click the button that opens the **Properties** dialog box. Depending on your software application, this button might be called **Properties**, **Options**, **Printer Setup**, **Printer**, or **Preferences**.
5. Change the paper orientation on the **Layout** tab, and paper source, media type, paper size, and quality settings on the **Paper/Quality** tab. To print in black and white, click the **Advanced** button, and then change the **Print in Grayscale** option.
6. Click **OK**.
7. Click **Print** or **OK** to begin printing.

Print documents (Mac OS X)

1. Load paper in the tray. For more information, see [Load media](#).
2. Select a paper size:
 - a. From the **File** menu in your software application, click **Page Setup**.

 **NOTE:** If you do not see a **Page Setup** menu item, go to step 3.
 - b. Make sure the printer you want to use is selected in the **Format For** pop-up menu.
 - c. Select the paper size from the **Paper Size** pop-up menu, and then click **OK**.
3. From the **File** menu in your software application, click **Print**.
4. Make sure the printer you want to use is selected.
5. Select the paper size from the **Paper Size** pop-up menu (if available).
6. Change the print settings for the option provided in the pop-up menus, as appropriate for your project.

 **NOTE:** If you do not see any options, click the disclosure triangle next to the **Printer** pop-up menu or click **Show Details**.
7. Click **Print** to begin printing.

Print brochures

Follow the instructions for your operating system.

- [Print brochures \(Windows\)](#)
- [Print brochures \(Mac OS X\)](#)

 **TIP:** This printer includes HP ePrint, a free service from HP that allows you to print documents on your HP ePrint-enabled printer anytime, from any location, without any additional software or printer drivers. For more information, see [HP ePrint](#).

Print brochures (Windows)

 **NOTE:** To set print settings for all print jobs, make the changes in the HP software provided with the printer. For more information on the HP software, see [Printer management tools](#).

1. Load paper in the tray. For more information, see [Load media](#).
2. On the **File** menu in your software application, click **Print**.
3. Make sure the printer you want to use is selected.
4. To change settings, click the button that opens the **Properties** dialog box. Depending on your software application, this button might be called **Properties**, **Options**, **Printer Setup**, **Printer**, or **Preferences**.
5. Change the paper orientation on the **Layout** tab, and paper source, media type, paper size, and quality settings on the **Paper/Quality** tab. To print in black and white, click the **Advanced** button, and then change the **Print in Grayscale** option.
6. Click **OK**.
7. Click **Print** or **OK** to begin printing.

Print brochures (Mac OS X)

1. Load paper in the tray. For more information, see [Load media](#).
2. Select a paper size:
 - a. From the **File** menu in your software application, click **Page Setup**.

 **NOTE:** If you do not see a **Page Setup** menu item, go to step 3.

- b. Make sure the printer you want to use is selected in the **Format For** pop-up menu.
- c. Select the paper size from the **Paper Size** pop-up menu, and then click **OK**.
3. From the **File** menu in your software application, click **Print**.
4. Make sure the printer you want to use is selected.
5. Select the paper size from the **Paper Size** pop-up menu (if available).
6. Click **Paper Type/Quality** from the pop-up menu, and then select the following settings:
 - **Paper Type:** The appropriate brochure paper type
 - **Quality:** **Normal** or **Best**

 **NOTE:** If you do not see these options, click the disclosure triangle next to the **Printer** pop-up menu or click **Show Details**.

7. Select any other print settings that you want, and then click **Print** to begin printing.

Print on envelopes

Avoid envelopes with the following characteristics:

- Very slick finish
- Self-stick adhesives, clasps, or windows

- Thick, irregular, or curled edges
- Areas that are wrinkled, torn, or otherwise damaged

Make sure the folds of envelopes you load in the printer are sharply creased.



NOTE: For more information about printing on envelopes, see the documentation available with the software program you are using.

Follow the instructions for your operating system.

- [Print on envelopes \(Windows\)](#)
- [Print on envelopes \(Mac OS X\)](#)

Print on envelopes (Windows)

1. Load envelopes print-side down in the tray. For more information, see [Load media](#).
2. On the **File** menu in your software application, click **Print**.
3. Make sure the printer you want to use is selected.
4. To change settings, click the button that opens the **Properties** dialog box. Depending on your software application, this button might be called **Properties**, **Options**, **Printer Setup**, **Printer**, or **Preferences**.
5. On the **Layout** tab, change the orientation to **Landscape**.
6. Click **Paper/Quality**, and then select the appropriate envelope type from the **Paper Size** drop-down list.



TIP: You can change more options for the print job by using the features available on the other tabs in the dialog box.

7. Click **OK**, and then click **Print** or **OK** to begin printing.

Print on envelopes (Mac OS X)

1. Load envelopes in the tray. For more information, see [Load media](#).
2. Select a paper size:
 - a. From the **File** menu in your software application, click **Page Setup**.

 **NOTE:** If you do not see a **Page Setup** menu item, go to step 3.
 - b. Make sure the printer you want to use is selected in the **Format For** pop-up menu.
 - c. Select the appropriate envelope size from the **Paper Size** pop-up menu, and then click **OK**.
3. From the **File** menu in your software application, click **Print**.
4. Make sure the printer you want to use is selected.
5. Select the appropriate envelope size in the **Paper Size** pop-up menu (if available).

6. Select the **Orientation** option.



NOTE: If you do not see these options, click the disclosure triangle next to the **Printer** pop-up menu or click **Show Details**.

7. Select any other print settings that you want, and then click **Print** to begin printing.

Print photos

Do not leave unused photo paper in the input tray. The paper might start to curl, which could impair the quality of your printout. Photo paper should be flat before printing.

Follow the instructions for your operating system.

- [Print photos on photo paper \(Windows\)](#)
- [Print photos on photo paper \(Mac OS X\)](#)



TIP: This printer includes HP ePrint, a free service from HP that allows you to print documents on your HP ePrint-enabled printer anytime, from any location, without any additional software or printer drivers. For more information, see [HP ePrint](#).

Print photos on photo paper (Windows)

1. Load paper in the tray. For more information, see [Load media](#).
2. On the **File** menu in your software application, click **Print**.
3. Make sure the printer you want to use is selected.
4. To change settings, click the option that opens the printer **Properties** dialog box. Depending on your software application, this option might be called **Properties**, **Options**, **Printer Setup**, **Printer**, or **Preferences**.
5. On the **Paper/Quality** tab, select the appropriate photo paper type from the **Media** drop-down menu.
6. Click **Advanced**, and then select **Best** or **Maximum DPI** from the **Output Quality** drop-down menu.
7. To print the photo in black and white, click the **Grayscale** drop-down menu, and then select one of the following options:
 - **High-Quality Grayscale:** uses all the available colors to print your photo in grayscale. This creates smooth and natural shades of gray.
 - **Black Ink Only:** uses black ink to print your photo in grayscale. The gray shading is created by varying patterns of black dots, which might result in a grainy image.
8. Click **OK**, and then click **Print** or **OK** to begin printing.

Print photos on photo paper (Mac OS X)

1. Load paper in the tray. For more information, see [Load media](#).
2. Select a paper size:
 - a. From the **File** menu in your software application, click **Page Setup**.

 **NOTE:** If you do not see a **Page Setup** menu item, go to step 3.

 - b. Make sure the printer you want to use is selected in the **Format For** pop-up menu.
 - c. Select the paper size from the **Paper Size** pop-up menu, and then click **OK**.
3. From the **File** menu in your software application, click **Print**.
4. Make sure the printer you want to use is selected.
5. Select the appropriate paper size from the **Paper Size** pop-up menu (if available).
6. Click **Paper Type/Quality** from the pop-up menu, and then select the following settings:
 - **Paper Type:** The appropriate photo paper type
 - **Quality: Best or Maximum dpi**

 **NOTE:** If you do not see these options, click the disclosure triangle next to the **Printer** pop-up menu or click **Show Details**.

7. If necessary, change the photo and color options:
 - a. Click the disclosure triangle beside **Color Options** and select the appropriate **Photo Fix** options:
 - **Off:** Applies no automatic adjustments to the image.
 - **Basic:** Automatically focuses the image; moderately adjusts image sharpness.
 - b. To print the photo in black and white, click **Grayscale** from the **Color** pop-up menu, and then select one of the following options:
 - **High Quality:** Uses all the available colors to print your photo in grayscale. This creates smooth and natural shades of gray.
 - **Black Print Cartridge Only:** Uses black ink to print your photo in grayscale. The gray shading is created by varying patterns of black dots, which might result in a grainy image.
8. Select any other print settings that you want, and then click **Print** to begin printing.

Print on special and custom-size paper

If your application supports custom-size paper, set the size in the application before printing the document. If not, set the size in the printer driver. You might need to reformat existing documents to print them correctly on custom-size paper.

Use only custom-size paper that is supported by the printer. For more information, see [Media specifications](#).

 **NOTE:** Defining custom-size media sizes is only available in the HP printing software in Mac OS X.

Follow the instructions for your operating system.

- [Print on special or custom-size paper \(Mac OS X\)](#)

Print on special or custom-size paper (Mac OS X)

 **NOTE:** Before you can print on custom-size paper, you must set up the custom size in the HP software provided with the printer. For instructions, see [Set up custom sizes \(Mac OS X\)](#).

1. Load the appropriate paper in the tray. For more information, see [Load media](#).
 2. Select a paper size:
 - a. From the **File** menu in your software application, click **Page Setup**.
-
-  **NOTE:** If you do not see a **Page Setup** menu item, go to step 3.
-
- b. Make sure the printer you want to use is selected in the **Format For** pop-up menu.
 - c. Select the paper size from the **Paper Size** pop-up menu, and then click **OK**.
3. From the **File** menu in your software application, click **Print**.
 4. Make sure the printer you want to use is selected.
 5. Select the appropriate paper size from the **Paper Size** pop-up menu (if available).
 6. Click **Paper Handling** from the pop-up menu.
 7. Under **Destination Paper Size**, click **Scale to fit paper size**, and then select the custom size.
 8. Select any other print settings that you want, and then click **Print** to begin printing.

Set up custom sizes (Mac OS X)

1. Load paper in the tray. For more information, see [Load media](#).
 2. From the **File** menu in your software application, click **Page Setup**, and then make sure the printer you want to use is selected in the **Format For** pop-up menu.
- OR -
From the **File** menu in your software application, click **Print**, and then make sure the printer you want to use is selected.
 3. Select **Manage Custom Sizes** in the **Paper Size** pop-up menu.
-
-  **NOTE:** If you do not see these options in the **Print** dialog, click the disclosure triangle next to the **Printer** pop-up menu or click **Show Details**.
-
4. Click the **+** on the left side of the screen, double-click **Untitled**, and type a name for the new, custom size.
 5. In the **Width** and **Height** boxes, type the dimensions, and then set the margins, if you want to customize them.
 6. Click **OK**.

Print borderless documents

Borderless printing lets you print to the edges of certain photo media types and a range of standard media sizes.



NOTE: You cannot print a borderless document if the paper type is set to **Plain paper**.

NOTE: Before printing a borderless document, open the file in a software application and assign the image size. Make sure the size corresponds to the media size on which you are printing the image.

NOTE: Not all applications support borderless printing.

Follow the instructions for your operating system.

- [Print borderless documents \(Windows\)](#)
- [Print borderless documents \(Mac OS X\)](#)

Print borderless documents (Windows)

1. Load paper in the tray. For more information, see [Load media](#).
2. On the **File** menu in your software application, click **Print**.
3. Make sure the printer you want to use is selected.
4. To change settings, click the button that opens the **Properties** dialog box. Depending on your software application, this button might be called **Properties**, **Options**, **Printer Setup**, **Printer**, or **Preferences**.
5. Click the **Paper/Quality** tab, and then click the **Advanced** button.
6. In the **Borderless Printing** option, click **Print Borderless**, and then click the **OK** button.
7. In the **Media** drop-down list, select the appropriate paper type.
8. Click **OK**, and then click **Print** or **OK** to begin printing.

Print borderless documents (Mac OS X)

1. Load paper in the tray. For more information, see [Load media](#).
2. Select a borderless paper size:
 - a. From the **File** menu in your software application, click **Page Setup**.



NOTE: If you do not see a **Page Setup** menu item, go to step 3.

- b. Make sure the printer you want to use is selected in the **Format For** pop-up menu.
 - c. Select an available borderless paper size from the **Paper Size** pop-up menu, and then click **OK**.
3. From the **File** menu in your software application, click **Print**.
4. Make sure the printer you want to use is selected.
5. Select the paper size from the **Paper Size** pop-up menu (if available).

6. Click **Paper Type/Quality** from the pop-up menu, and then select the following settings:
 - **Paper Type:** The appropriate paper type
 - **Quality:** **Best** or **Maximum dpi**

 **NOTE:** If you do not see these options, click the disclosure triangle next to the **Printer** pop-up menu or click **Show Details**.

7. Make sure the **Print Borderless** check box is selected.
8. If necessary, click the disclosure triangle beside **Color Options** and select the appropriate **Photo Fix** options:
 - **Off:** Applies no automatic adjustments to the image.
 - **Basic:** Automatically focuses the image; moderately adjusts image sharpness.
9. Select any other print settings that you want, and then click **Print** to begin printing.

3 Scan

You can use the printer's control panel to scan documents, photos, and other originals and send them to a variety of destinations, such as a folder on a computer. You can also scan these originals from your computer using either the HP software provided with the printer or TWAIN-compliant or WIA-compliant programs.

When scanning documents, you can use the HP software to scan documents into a format that you can search, copy, paste, and edit.

 **NOTE:** The HP scanning software does not support TWAIN and WIA scanning on computers running Mac OS X.

NOTE: Some scan functions are only available after you install the HP recommended software.

 **TIP:** If you have problems scanning documents, see [Solve scan problems](#).

This section contains the following topics:

- [Scan an original](#)
- [Scan using Webscan](#)
- [Scanning documents as editable text](#)

Scan an original

This section contains the following topics:

 **NOTE:** Your printer and computer must be connected and turned on.

NOTE: If you are scanning an original from the printer control panel or from your computer using the HP printer software, the HP software provided with the printer must be installed on your computer prior to scanning. In addition, on Windows computers, the HP software must be running prior to scanning.

NOTE: If you are scanning a borderless original, load the original on the scanner glass, not the ADF.

- [Scan to a computer](#)

Scan to a computer

To scan an original to a computer from the printer control panel

 **NOTE:** If your printer is connected to a network and you are scanning to a Windows computer, before you can scan from the control panel, you need to enable scanning from the software. From the computer desktop, click **Start**, select **Programs** or **All Programs**, select the folder for your HP printer, and then select the option for your HP printer. Double-click **Scanner Actions**, double-click **Manage Scan to Computer**, and then click **Enable**.

Use these steps to scan from the control panel.

1. Load your original print-side down in the right-front corner of the glass or in the ADF. For more information, see [Load an original on the scanner glass](#) or [Load an original in the automatic document feeder \(ADF\)](#).
2. Touch **Scan**, and then select **Computer**.
3. Make changes to scan options, if needed.
4. Touch **Start Scan**.

To scan an original from HP scanning software

1. Load your original print-side down in the right-front corner of the glass or in the ADF. For more information, see [Load an original on the scanner glass](#) or [Load an original in the automatic document feeder \(ADF\)](#).
2. On the computer, open the HP scanning software:
 - **Windows:** From the computer desktop, click **Start**, select **Programs** or **All Programs**, select the folder for your HP printer, and then select **HP Scan**.
 - **Mac OS X:** Double-click the **HP Scan 3** icon. This icon is located in the **Hewlett-Packard** folder that is in the **Applications** folder at the top level of the hard disk.
3. Select a scan shortcut. Make changes to the scan settings, if needed.
4. To start the scan, click **Scan**.

 **NOTE:** Use the HP software to scan documents into editable text, a format that allows you to search, copy, paste, and edit within the scanned document. Use this format to edit letters, newspaper clippings, and many other documents. For more information, see [Scanning documents as editable text](#).

Scan using Webscan

Webscan is a feature of the embedded web server that lets you scan photos and documents from your printer to your computer using a web browser. This feature is available even if you did not install the printer software on your computer.

 **NOTE:** If you are unable to open Webscan in the EWS, your network administrator might have turned it off. For more information, contact your network administrator or the person who set up your network.

For more information, see [Embedded web server](#).

To scan using Webscan

1. Load your original print-side down in the right-front corner of the glass or in the ADF. For more information, see [Load an original on the scanner glass](#) or [Load an original in the automatic document feeder \(ADF\)](#).
2. Open the embedded web server. For more information, see [Embedded web server](#).
3. Click the **Scan** tab, click **Webscan** in the left pane, change any settings, and then click **Start Scan**.

 **TIP:** To scan documents as editable text, you must install the HP software included with the printer. For more information, see [Scanning documents as editable text](#).

Scanning documents as editable text

When scanning documents, you can use the HP software to scan documents into a format that you can search, copy, paste, and edit. This allows you to edit letters, newspaper clippings, and many other documents.

This section contains the following topics:

- [To scan documents as editable text](#)
- [Guidelines for scanning documents as editable text](#)

To scan documents as editable text

Use the following guidelines for scanning documents as editable text.

Follow the instructions for your operating system.

Windows

1. Load your original print-side down in the right-front corner of the glass or in the ADF. For more information, see [Load an original on the scanner glass](#) or [Load an original in the automatic document feeder \(ADF\)](#).
2. From the computer desktop, click **Start**, select **Programs** or **All Programs**, select the folder for your HP printer, and then select **HP Scan**.
3. Select the type of editable text you want to use in the scan:

I want to...	Follow these steps
Extract just the text, without any of the formatting of the original	Select the Save as Editable Text (OCR) shortcut from the list, and then select Text (.txt) from the File Type drop-down menu.
Extract the text, as well as some of the formatting of the original	Select the Save as Editable Text (OCR) shortcut from the list, and then select Rich Text (.rtf) from the File Type drop-down menu. Or Select the Save as PDF shortcut from the list, and then select Searchable PDF (.pdf) from the File Type drop-down menu.

4. To start the scan, click **Scan**, and then follow the onscreen instructions.

Mac OS X

1. Load your original print-side down in the right-front corner of the glass or in the ADF. For more information, see [Load an original on the scanner glass](#) or [Load an original in the automatic document feeder \(ADF\)](#).
2. Double-click the HP Scan 3 icon. This icon is located in the **Hewlett-Packard** folder in the **Applications** folder at the top level of the hard disk.

3. From the **HP Scan** menu, click **Preferences**.
4. Select the **Documents** preset from the **Presets** pop-up menu.
5. To start the scan, click **Scan**.
6. After the scan is complete, click the **Save** button in the HP Scan toolbar
7. Select the type of editable text you want to use in the scan:

I want to...	Follow these steps
Extract just the text, without any of the formatting of the original	Select TEXT from the Format pop-up menu.
Extract the text, as well as some of the formatting of the original	Select RTF or PDF-Searchable from the Format pop-up menu.

8. Click **Save**.

Guidelines for scanning documents as editable text

To ensure that the software can convert your documents successfully, do the following:

- **Make sure the scanner glass or ADF window is clean.**
When the printer scans the document, smudges or dust on the scanner glass or ADF window can be scanned, as well, and can prevent the software from converting the document to editable text.
- **Make sure the document is loaded correctly.**
When scanning documents as editable text from the ADF, the original must be loaded into the ADF with the top forward and face up. When scanning from the scanner glass, the original must be loaded with the top facing the right edge of the scanner glass.
Also, make sure the document is not skewed. For more information, see [Load an original on the scanner glass](#) or [Load an original in the automatic document feeder \(ADF\)](#).
- **Make sure the text on the document is clear.**
To successfully convert the document to editable text, the original must be clear and of high quality. The following conditions can cause the software to not convert the document successfully:
 - The text on the original is faint or wrinkled.
 - The text is too small.
 - The structure of the document is too complex.
 - The text is tightly spaced. For example, if the text that the software converts has missing or combined characters, "rn" might appear as "m."
 - The text is on a colored background. Colored backgrounds can cause images in the foreground to blend too much.

- **Choose the correct profile.**

Be sure to select a shortcut or preset that allows scanning as editable text. These options use scan settings designed to maximize the quality of your OCR scan. In Windows, use the **Editable Text (OCR)** or **Save as PDF** shortcuts. In Mac OS X, use the **Documents** preset.

- **Save your file in the correct format.**

If you want to extract just the text from the document, without any of the formatting of the original, select a plain text format (such as **Text (.txt)** or **TXT**). If you want to extract the text, as well as some of the formatting of the original, select Rich Text Format (such as **Rich Text (.rtf)** or **RTF**) or searchable PDF format (**Searchable PDF (.pdf)** or **PDF-Searchable**).

4 Copy

You can produce high-quality color and grayscale copies on a variety of paper types and sizes.

 **NOTE:** If you are copying a document when a fax arrives, the fax is stored in the printer's memory until the copying finishes. This can reduce the number of fax pages stored in memory.

This section contains the following topics:

- [Copy documents](#)
- [Change copy settings](#)

Copy documents

You can make quality copies from the printer control panel.

To copy documents

1. Make sure you have paper loaded in the main tray. For more information, see [Load media](#).
2. Place your original face down on the scanner glass or face up in the ADF. For more information, see [Load an original on the scanner glass](#) or [Load an original in the automatic document feeder \(ADF\)](#).

 **NOTE:** If you are copying a photo, place the photo on the scanner glass face down, as shown on the icon on the edge of the scanner glass.

3. Touch **Copy**.
4. Change any additional settings. For more information, see [Change copy settings](#).
5. To start the copy job, touch **Start Black** or **Start Color**.

 **NOTE:** If you have a color original, selecting **Start Black** produces a black-and-white copy of the color original, while selecting **Start Color** produces a full-color copy of the color original.

Change copy settings

You can customize copy jobs using the various settings available from the printer's control panel, including the following:

- Number of copies
- Copy paper size
- Copy paper type
- Copy speed or quality
- Lighter/Darker settings
- Resizing originals to fit on different paper sizes

You can use these settings for single copy jobs, or you can save settings to be used as defaults for future jobs.

To change copy settings for a single job

1. Touch **Copy**.
2. Select the copy function settings you want to change.
3. Touch **Start Black** or **Start Color**.

To save the current settings as defaults for future jobs

1. Touch **Copy**.
2. Make any changes to the copy function settings, and then touch **Settings**.
3. Touch ▼ (down arrow), and then select **Set As New Defaults**.
4. Touch **Yes, change defaults**, and then select **Done**.

5 Fax

You can use the printer to send and receive faxes, including color faxes. You can schedule faxes to be sent at a later time and set up speed-dials to send faxes quickly and easily to frequently used numbers. From the printer control panel, you can also set a number of fax options, such as resolution and the contrast between lightness and darkness on the faxes you send.

 **NOTE:** Before you begin faxing, make sure you have set up the printer correctly for faxing. You might have already done this as part of the initial setup, by using either the control panel or the HP software provided with the printer. You can verify the fax is set up correctly by running the fax setup test from the control panel. For more information on the fax test, see [Test fax setup](#).

This section contains the following topics:

- [Send a fax](#)
- [Receive a fax](#)
- [Set up speed-dial entries](#)
- [Change fax settings](#)
- [Fax and digital phone services](#)
- [Fax over Internet Protocol](#)
- [Use reports](#)

Send a fax

You can send a fax in a variety of ways. Using the printer control panel, you can send a black-and-white or color fax. You can also send a fax manually from an attached phone. This allows you to speak with the recipient before sending the fax.

This section contains the following topics:

- [Send a standard fax](#)
- [Send a standard fax from the computer](#)
- [Send a fax manually from a phone](#)
- [Send a fax using monitor dialing](#)
- [Send a fax from memory](#)
- [Schedule a fax to send later](#)
- [Send a fax to multiple recipients](#)
- [Send a fax in Error Correction Mode](#)

Send a standard fax

You can easily send a single- or multiple-page black-and-white or color fax by using the printer control panel.

 **NOTE:** If you need printed confirmation that your faxes were successfully sent, enable fax confirmation **before** sending any faxes.

-  **TIP:** You can also send a fax manually from a phone or by using monitor dialing. These features allow you to control the pace of your dialing. They are also useful when you want to use a calling card to charge the call and you have to respond to tone prompts while dialing.
-

To send a standard fax from the printer control panel

1. Load your original print-side down in the right-front corner of the glass or in the ADF. For more information, see [Load an original on the scanner glass](#) or [Load an original in the automatic document feeder \(ADF\)](#).
2. Touch **Fax**.
3. Enter the fax number by using the keypad.

-  **TIP:** To add a pause in the fax number you are entering, touch * repeatedly, until a dash (-) appears on the display.
-

4. Touch **Start Black** or **Start Color**.
If the printer detects an original loaded in the automatic document feeder, it sends the document to the number you entered.

-  **TIP:** If the recipient reports issues with the quality of the fax you sent, you can try changing the resolution or contrast of your fax.
-

Send a standard fax from the computer

You can send a document on your computer as a fax, without printing a copy and faxing it from the printer.

-  **NOTE:** Faxes sent from your computer by this method use the printer's fax connection, not your Internet connection or computer modem. Therefore, make sure the printer is connected to a working telephone line and that the fax function is set up and functioning correctly.
-

To use this feature, you must install the printer software using the installation program provided on the HP software CD provided with the printer.

Windows

1. Open the document on your computer that you want to fax.
2. On the **File** menu in your software application, click **Print**.
3. From the **Name** list, select the printer that has “**fax**” in the name.
4. To change settings (such as selecting to send the document as a black fax or a color fax), click the button that opens the **Properties** dialog box. Depending on your software application, this button might be called **Properties**, **Options**, **Printer Setup**, **Printer**, or **Preferences**.
5. After you have changed any settings, click **OK**.
6. Click **Print** or **OK**.
7. Enter the fax number and other information for the recipient, change any further settings for the fax, and then click **Send Fax**. The printer begins dialing the fax number and faxing the document.

Mac OS X

1. Open the document on your computer that you want to fax.
2. From the **File** menu in your software application, click **Print**.
3. Select the printer that has “**(Fax)**” in the name.
4. Select **Fax Recipients** from the pop-up menu below the **Orientation** setting.

 **NOTE:** If you cannot find the pop-up menu, try clicking the disclosure triangle next to the **Printer selection**.

5. Enter the fax number and other information in the boxes provided, and then click **Add to Recipients**.
6. Select the **Fax Mode** and any other fax options you want, and then click **Send Fax Now** to begin dialing the fax number and faxing the document.

Send a fax manually from a phone

Sending a fax manually allows you to make a phone call and talk with the recipient before you send the fax. This is useful if you want to inform the recipient that you are going to send them a fax before sending it. When you send a fax manually, you can hear the dial tones, telephone prompts, or other sounds through the handset on your telephone. This makes it easy for you to use a calling card to send your fax.

Depending on how the recipient has their fax machine set up, the recipient might answer the phone, or the fax machine might take the call. If a person answers the phone, you can speak with the recipient before sending the fax. If a fax machine answers the call, you can send the fax directly to the fax machine when you hear the fax tones from the receiving fax machine.

To send a fax manually from an extension phone

1. Load your original print-side down in the right-front corner of the glass or in the ADF. For more information, see [Load an original on the scanner glass](#) or [Load an original in the automatic document feeder \(ADF\)](#).
2. Touch **Fax**.
3. Dial the number by using the keypad on the phone that is connected to the printer.

 **NOTE:** Do not use the keypad on the control panel of the printer when manually sending a fax. You must use the keypad on your phone to dial the recipient's number.

4. If the recipient answers the telephone, you can engage in a conversation before sending your fax.

 **NOTE:** If a fax machine answers the call, you will hear fax tones from the receiving fax machine. Proceed to the next step to transmit the fax.

5. When you are ready to send the fax, touch **Start Black** or **Start Color**.

 **NOTE:** If prompted, select **Send Fax**.

If you were speaking with the recipient before sending the fax, inform the recipient that they should press **Start** on their fax machine after they hear fax tones.

The telephone line is silent while the fax is transmitting. At this point, you can hang up the telephone. If you want to continue speaking with the recipient, remain on the line until the fax transmission is complete.

Send a fax using monitor dialing



Monitor dialing allows you to dial a number from the printer control panel as you would dial a regular telephone. When you send a fax using monitor dialing, you can hear the dial tones, telephone prompts, or other sounds through the speakers on the printer. This enables you to respond to prompts while dialing, as well as control the pace of your dialing.

 **TIP:** If you are using a calling card and do not enter your PIN fast enough, the printer might start sending fax tones too soon and cause your PIN not to be recognized by the calling card service. If this is the case, you can create a speed dial entry to store the PIN for your calling card. For more information, see [Set up speed-dial entries](#).

 **NOTE:** Make sure the volume is turned on to hear a dial tone.

To send a fax using monitor dialing from the printer control panel

1. Load your originals. For additional information, see [Load an original on the scanner glass](#) or [Load an original in the automatic document feeder \(ADF\)](#).
2. Touch **Fax**, and then touch **Start Black** or **Start Color**.
If the printer detects an original loaded in the automatic document feeder, you hear a dial tone.
3. When you hear the dial tone, enter the number by using the keypad on the printer control panel.
4. Follow any prompts that might occur.

 **TIP:** If you are using a calling card to send a fax and you have your calling card PIN stored as a speed dial, when prompted to enter your PIN, touch  (Speed Dial) to select the speed dial entry where you have your PIN stored.



Your fax is sent when the receiving fax machine answers.

Send a fax from memory

You can scan a black-and-white fax into memory and then send the fax from memory. This feature is useful if the fax number you are trying to reach is busy or temporarily unavailable. The printer scans the originals into memory and sends them once it is able to connect to the receiving fax machine. After the printer scans the pages into memory, you can immediately remove the originals from the document feeder tray or scanner glass.

 **NOTE:** You can only send a black-and-white fax from memory.

To send a fax from memory

1. Load your originals. For additional information, see [Load an original on the scanner glass](#) or [Load an original in the automatic document feeder \(ADF\)](#).
2. Touch **Fax**, and then touch **Settings**.
3. Touch **Scan and Fax**.
4. Enter the fax number by using the keypad, touch  (Speed Dial) to select a speed dial, or touch  (Call History) to select a previously dialed or received number.
5. Touch **Start Fax**.
The printer scans the originals into memory and sends the fax when the receiving fax machine is available.





Schedule a fax to send later

You can schedule a black-and-white fax to be sent within the next 24 hours. This enables you to send a black-and-white fax late in the evening, when phone lines are not as busy or phone rates are lower, for example. The printer automatically sends your fax at the specified time.

You can only schedule one fax to be sent at a time. You can continue to send faxes normally, however, while a fax is scheduled.

 **NOTE:** You can only send scheduled faxes in black-and-white.

To schedule a fax from the printer control panel

1. Load your originals. For additional information, see [Load an original in the automatic document feeder \(ADF\)](#).
2. Touch **Fax**, and then touch **Settings**.
3. Touch **Send Fax Later**.
4. Enter the send time by touching  (up arrow) and  (down arrow), touch **AM** or **PM**, and then select **Done**.
5. Enter the fax number by using the keypad, touch  (Speed Dial) to select a speed dial, or touch  (Call History) to select a previously dialed or received number.
6. Touch **Start Fax**.
The printer scans all pages and the scheduled time appears on the display. The fax is sent at the scheduled time.

To cancel a scheduled fax

1. Touch the **Send Fax Later** message on the display.
– OR –
Touch **Fax**, and then select **Fax Options** or **Fax Settings**.
2. Touch **Cancel Scheduled Fax**.

Send a fax to multiple recipients

You can send a fax to multiple recipients at once by grouping individual speed dial entries into group speed dial entries.

To send a fax to multiple recipients using group speed dial

1. Load your originals. For additional information, see [Load an original on the scanner glass](#) or [Load an original in the automatic document feeder \(ADF\)](#).
2. Touch **Fax**, touch  (Speed Dial), and then select the recipient group.
3. Touch **Start Black**.
If the printer detects an original loaded in the automatic document feeder, it sends the document to each number in the group speed dial entry.

 **NOTE:** You can only use group speed dial entries to send faxes in black and white, because of memory limitations. The printer scans the fax into memory then dials the first number. When a connection is made, it sends the fax and dials the next number. If a number is busy or not answering, the printer follows the settings for **Busy Redial** and **No Answer Redial**. If a connection cannot be made, the next number is dialed and an error report is generated.

Send a fax in Error Correction Mode

Error Correction Mode (ECM) prevents loss of data due to poor phone lines by detecting errors that occur during transmission and automatically requesting retransmission of the erroneous portion. Phone charges are unaffected, or might even be reduced, on good phone lines. On poor phone lines, ECM increases sending time and phone charges, but sends the data much more reliably. The default setting is **On**. Turn ECM off only if it increases phone charges substantially, and if you can accept poorer quality in exchange for reduced charges.

Before turning the ECM setting off, consider the following. If you turn ECM off:

- The quality and transmission speed of faxes you send and receive are affected.
- The **Fax Speed** is automatically set to **Medium**.
- You can no longer send or receive faxes in color.

To change the ECM setting from the control panel

1. From the Home screen, touch , and then select **Setup**.
2. Touch **Fax Setup**, and then select **Advanced Fax Setup**.
3. Select **Error Correction Mode**.
4. Select **On** or **Off**.

Receive a fax

You can receive faxes automatically or manually. If you turn off the **Auto Answer** option, you must receive faxes manually. If you turn on the **Auto Answer** option (the default setting), the printer automatically answers incoming calls and receives faxes after the number of rings that are specified by the **Rings to Answer** setting. (The default **Rings to Answer** setting is five rings.)

If you receive a Legal-size or larger fax and the printer is not currently set to use Legal-size paper, the printer reduces the fax so that it fits on the paper that is loaded. If you have disabled the **Automatic Reduction** feature, the printer prints the fax on two pages.

 **NOTE:** If you are copying a document when a fax arrives, the fax is stored in the printer memory until the copying finishes. This can reduce the number of fax pages stored in memory.

- [Receive a fax manually](#)
- [Set up backup fax](#)
- [Reprint received faxes from memory](#)
- [Poll to receive a fax](#)
- [Forward faxes to another number](#)
- [Set the paper size for received faxes](#)
- [Set automatic reduction for incoming faxes](#)
- [Block unwanted fax numbers](#)
- [Receive faxes to your computer using HP Digital Fax \(Fax to PC and Fax to Mac\)](#)

Receive a fax manually

When you are on the phone, the person you are speaking with can send you a fax while you are still connected. This is referred to as manual faxing. Use the instructions in this section to receive a manual fax.

 **NOTE:** You can pick up the handset to talk or listen for fax tones.

You can receive faxes manually from a phone that is:

- Directly connected to the printer (on the 2-EXT port)
- On the same phone line, but not directly connected to the printer

To receive a fax manually

1. Make sure the printer is turned on and you have paper loaded in the main tray.
2. Remove any originals from the document feeder tray.
3. Set the **Rings to Answer** setting to a high number to allow you to answer the incoming call before the printer answers. Or, turn off the **Auto Answer** setting so that the printer does not automatically answer incoming calls.

4. If you are currently on the phone with the sender, instruct the sender to press **Start** on their fax machine.
5. When you hear fax tones from a sending fax machine, do the following:
 - a. Touch **Fax**, and then select **Start Black** or **Start Color**.
 - b. After the printer begins to receive the fax, you can hang up the phone or remain on the line. The phone line is silent during fax transmission.

Set up backup fax

Depending on your preference and security requirements, you can set up the printer to store all the faxes it receives, only the faxes it receives while the printer is in an error condition, or none of the faxes it receives.

The following backup fax modes are available:

On	<p>The default setting. When Backup fax is On, the printer stores all received faxes in memory. This enables you to reprint up to eight of the most recently printed faxes if they are still saved in memory.</p> <p>NOTE: When printer memory is low, it overwrites the oldest, printed faxes as it receives new faxes. If the memory becomes full of unprinted faxes, the printer stops answering incoming fax calls.</p> <p>NOTE: If you receive a fax that is too large, such as a very detailed color photo, it might not be stored in memory due to memory limitations.</p>
On Error Only	<p>Causes the printer to store faxes in memory only if an error condition exists that prevents the printer from printing the faxes (for example, if the printer runs out of paper). The printer continues to store incoming faxes as long as there is memory available. (If the memory becomes full, the printer stops answering incoming fax calls.) When the error condition is resolved, the faxes stored in memory print automatically, and then they are deleted from memory.</p>
Off	<p>Faxes are never stored in memory. For example, you might want to turn off Backup fax for security purposes. If an error condition occurs that prevents the printer from printing (for example, the printer runs out of paper), the printer stops answering incoming fax calls.</p>

 **NOTE:** If backup fax is enabled and you turn the printer off, all faxes stored in memory are deleted, including any unprinted faxes that you might have received while the printer was in an error condition. You must contact the senders to ask them to resend any unprinted faxes. For a list of the faxes you have received, print the **Fax Log**. The **Fax Log** is not deleted when the printer is turned off.

To set backup fax from the printer control panel

1. Touch , and then select **Setup**.
2. Touch **Fax Setup**, and then select **Advanced Fax Setup**.
3. Touch **Backup Fax Reception**.
4. Touch **On**, **On Error Only**, or **Off**.



Reprint received faxes from memory

If you set the **Backup fax** mode to **On**, the received faxes are stored in memory, whether the printer has an error condition or not.

 **NOTE:** After the memory becomes full, the oldest, printed faxes are overwritten as new faxes are received. If all the stored faxes are unprinted, the printer does not receive any fax calls until you print or delete the faxes from memory. You might also want to delete the faxes in memory for security or privacy purposes.

Depending on the sizes of the faxes in memory, you can reprint up to eight of the most recently printed faxes, if they are still in memory. For example, you might need to reprint your faxes if you lost the copy of your last printout.

To reprint faxes in memory from the printer control panel

1. Make sure you have paper loaded in the main tray. For more information, see [Load media](#).
2. Touch , and then select **Setup**.
3. Touch **Fax Setup**, touch **Fax Tools**, and then select **Reprint Faxes in Memory**. The faxes are printed in the reverse order from which they were received with the most recently received fax printed first, and so on.
4. If you want to stop reprinting the faxes in memory, touch  (Cancel button).

Poll to receive a fax

Polling allows the printer to ask another fax machine to send a fax that it has in its queue. When you use the **Poll to Receive** feature, the printer calls the designated fax machine and requests the fax from it. The designated fax machine must be set for polling and have a fax ready to send.

 **NOTE:** The printer does not support polling pass codes. Polling pass codes are a security feature that require the receiving fax machine to provide a pass code to the printer it is polling in order to receive the fax. Make sure the printer you are polling does not have a pass code set up (or has not changed the default pass code) or the printer cannot receive the fax.

To set up poll to receive a fax from the printer control panel

1. Touch **Fax**, and then select **Settings**.
2. Touch **Poll to Receive**.
3. Enter the fax number of the other fax machine.
4. Touch **Start Fax**.

Forward faxes to another number

You can set up the printer to forward your faxes to another fax number. A received color fax is forwarded in black and white.

HP recommends that you verify the number you are forwarding to is a working fax line. Send a test fax to make sure the fax machine is able to receive your forwarded faxes.

To forward faxes from the printer control panel

1. Touch , and then select **Setup**.
2. Touch **Fax Setup**, and then select **Advanced Fax Setup**.
3. Touch **Fax Forwarding**.

4. Touch **On (Print and Forward)** to print and forward the fax, or select **On (Forward)** to forward the fax.

 **NOTE:** If the printer is not able to forward the fax to the designated fax machine (for example, if it is not turned on), the printer prints the fax. If you set up the printer to print error reports for received faxes, it also prints an error report.

5. At the prompt, enter the number of the fax machine intended to receive the forwarded faxes, and then touch **Done**. Enter the required information for each of the following prompts: start date, start time, end date, and end time.
6. Fax forwarding is activated. Touch **OK** to confirm.
If the printer loses power when fax forwarding is set up, it saves the fax forwarding setting and phone number. When the power is restored to the printer, the fax forwarding setting is still **On**.

 **NOTE:** You can cancel fax forwarding by selecting **Off** from the **Fax Forwarding** menu.

Set the paper size for received faxes

You can select the paper size for received faxes. The paper size you select should match what is loaded in your main tray. Faxes can be printed on Letter, A4, or Legal paper only.

 **NOTE:** If an incorrect paper size is loaded in the main tray when you receive a fax, the fax does not print and an error message appears on the display. Load Letter, A4, or Legal paper, and then touch **OK** to print the fax.

To set the paper size for received faxes from the printer control panel

1. Touch  (right arrow), and then select **Setup**.
2. Touch **Fax Setup**, and then select **Basic Fax Setup**.
3. Touch **Fax Paper Size**, and then select an option.

Set automatic reduction for incoming faxes

The **Automatic Reduction** setting determines what the printer does if it receives a fax that is too large for the default paper size. This setting is turned on by default, so the image of the incoming fax is reduced to fit on one page, if possible. If this feature is turned off, information that does not fit on the first page is printed on a second page. **Automatic Reduction** is useful when you receive a Legal-size fax and Letter-size paper is loaded in the main tray.

To set automatic reduction from the printer control panel

1. Touch  (right arrow), and then select **Setup**.
2. Touch **Fax Setup**, and then select **Advanced Fax Setup**.
3. Touch **Automatic Reduction**, and then select **On** or **Off**.

Block unwanted fax numbers

If you subscribe to a caller ID service through your phone provider, you can block specific fax numbers so the printer does not print faxes received from those numbers.

When an incoming fax call is received, the printer compares the number to the list of junk fax numbers to determine if the call should be blocked. If the number matches a number in the blocked fax numbers list, the fax is not printed. (The maximum number of fax numbers you can block varies by model.)

 **NOTE:** This feature is not supported in all countries/regions. If it is not supported in your country/region, **Junk Fax Blocker** does not appear in the **Fax Options** or **Fax Settings** menu.

NOTE: If no phone numbers are added in the Caller ID list, it is assumed that you are not subscribed to a Caller ID service.

- [Add numbers to the junk fax list](#)
- [Remove numbers from the junk fax list](#)
- [Print a Junk Fax Report](#)

Add numbers to the junk fax list

You can block specific numbers by adding them to the junk fax list.

To add a number to the junk fax list

1. Touch , and then touch **Setup**.
2. Touch **Fax Setup**, and then select **Basic Fax Setup**.
3. Touch **Junk Fax Blocker**.
4. A message appears stating that Caller ID is required to block junk faxes. Touch **OK** to continue.
5. Touch **Add Numbers**.
6. To select a fax number to block from the caller ID list, touch **Select from Caller ID History**.
- or -
To manually enter a fax number to block, touch **Enter new number**.
7. After entering a fax number to block, touch **Done**.

 **NOTE:** Make sure you enter the fax number as it appears on the control panel display, and not the fax number that appears on the fax header of the received fax, as these numbers can be different.

Remove numbers from the junk fax list

If you no longer want to block a fax number, you can remove a number from your junk fax list.

To remove numbers from the list of junk fax numbers

1. Touch , and then touch **Setup**.
2. Touch **Fax Setup**, and then touch **Basic Fax Setup**.
3. Touch **Junk Fax Blocker**.
4. Touch **Remove Numbers**.
5. Touch the number you want to remove, and then touch **OK**.

Print a Junk Fax Report

Use the following procedure to print a list of blocked junk fax numbers.

To print a Junk Fax Report

1. Touch  (right arrow), and then touch **Setup**.
2. Touch **Fax Setup**, and then touch **Basic Fax Setup**.
3. Touch **Junk Fax Blocker**.
4. Touch **Print Reports**, and then touch **Junk Fax List**.

Receive faxes to your computer using HP Digital Fax (Fax to PC and Fax to Mac)

If the printer is connected to your computer with a USB cable, you can use HP Digital Fax (Fax to PC and Fax to Mac) to automatically receive faxes and save faxes directly to your computer. With Fax to PC and Fax to Mac, you can store digital copies of your faxes easily and also eliminate the hassle of dealing with bulky paper files.

Received faxes are saved as TIFF (Tagged Image File Format). Once the fax is received, you get an onscreen notification with a link to the folder where the fax is saved.

The files are named in the following method: XXXX_YYYYYYYY_ZZZZZZ.tif, where X is the sender's information, Y is the date, and Z is the time that the fax was received.



NOTE: Fax to PC and Fax to Mac are available for receiving black-and-white faxes only. Color faxes are printed instead of being saved to the computer.

This section contains the following topics:

- [Fax to PC and Fax to Mac requirements](#)
- [Activate Fax to PC and Fax to Mac](#)
- [Modify Fax to PC and Fax to Mac settings](#)

Fax to PC and Fax to Mac requirements

- The administrator computer, the computer that activated the Fax to PC or Fax to Mac feature, must be on at all times. Only one computer can act as the Fax to PC or Fax to Mac administrator computer.
- The destination folder's computer or server must be on at all times. The destination computer must also be awake, faxes will not be saved if the computer is asleep or in hibernate mode.
- Paper must be loaded in the input tray. For more information, see [Load media](#).

Activate Fax to PC and Fax to Mac

On a computer running Windows, you can use the Digital Fax Setup Wizard to activate Fax to PC. On a Macintosh computer, you can use the HP Utility.

To set up Fax to PC (Windows)

1. From the computer desktop, click **Start**, select **Programs** or **All Programs**, select the folder for your HP printer, and then select the option for your HP printer.
2. Double-click **Fax Actions**, and then double-click **Digital Fax Setup Wizard**.
3. Follow the on-screen instructions.

To set up Fax to Mac (Mac OS X)

1. Open HP Utility. For more information, see [HP Utility \(Mac OS X\)](#).
2. Click the **Applications** icon on the HP Utility toolbar.
3. Double-click **HP Setup Assistant**, and then follow the on-screen instructions.

Modify Fax to PC and Fax to Mac settings

You can update the Fax to PC settings from your computer at any time from the Digital Fax Setup Wizard. You can update the Fax to Mac settings from the HP Utility.

You can turn off Fax to PC or Fax to Mac and disable printing faxes from the printer's control panel.

To modify settings from the printer's control panel

1. Touch  (right arrow), and then touch **Setup**.
2. Touch **Fax Setup**, touch **Basic Fax Setup**, and then touch **Fax to PC**.
3. Select the setting that you want to change. You can change the following settings:
 - **View PC hostname:** View the name of the computer that is set up to administer Fax to PC or Fax to Mac.
 - **Turn Off:** Turn off Fax to PC or Fax to Mac.

 **NOTE:** Use the HP software on your computer to turn on Fax to PC or Fax to Mac.

- **Disable Fax Print:** Choose this option to print faxes as they are received. If you turn off printing, color faxes will still print.

To modify settings from the HP software (Windows)

1. From the computer desktop, click **Start**, select **Programs** or **All Programs**, select the folder for your HP printer, and then select the option for your HP printer.
2. Double-click **Fax Actions**, and then double-click **Digital Fax Setup Wizard**.
3. Follow the onscreen instructions.

To modify settings from the HP software (Mac OS X)

1. Open HP Utility. For more information, see [HP Utility \(Mac OS X\)](#).
2. Click the **Applications** icon on the HP Utility toolbar.
3. Double-click **HP Setup Assistant**, and then follow the on-screen instructions.

Turn off Fax to PC or Fax to Mac

1. Touch  (right arrow), and then touch **Setup**.
2. Touch **Fax Setup**, touch **Basic Fax Setup**, and then touch **Fax to PC**.
3. Touch **Turn Off**.

Set up speed-dial entries

You can set up frequently used fax numbers as speed-dial entries. This lets you dial those numbers quickly by using the printer's control panel.

 **TIP:** In addition to creating and managing speed-dial entries from the printer's control panel, you can also use tools available on your computer, such as the HP software included with the printer and the printer's embedded web server (EWS). For more information, see [Printer management tools](#).

This section contains the following topics:

- [Set up and change speed-dial entries](#)
- [Set up and change group speed-dial entries](#)
- [Delete speed-dial entries](#)
- [Print a list of speed-dial entries](#)

Set up and change speed-dial entries

You can store fax numbers as speed-dial entries.

To set up speed-dial entries

1. On the printer's control panel, touch  (right arrow), and then touch **Setup**.
2. Touch **Fax Setup**, and then select **Speed Dial Setup**.
3. Touch **Add/Edit Speed Dial**, and then touch an unused entry number.
4. Type the fax number, and then touch **Next**.

 **NOTE:** Be sure to include any pauses or other required numbers, such as an area code, an access code for numbers outside a PBX system (usually a 9 or 0), or a long-distance prefix.

5. Type the name for the speed-dial entry, and then touch **Done**.

To change speed-dial entries

1. On the printer's control panel, touch  (right arrow), and then touch **Setup**.
2. Touch **Fax Setup**, and then select **Speed Dial Setup**.
3. Touch **Add/Edit Speed Dial**, and then touch the speed-dial entry you want to change.

4. If you want to change the fax number, type the new number, and then touch **Next**.

 **NOTE:** Be sure to include any pauses or other required numbers, such as an area code, an access code for numbers outside a PBX system (usually a 9 or 0), or a long-distance prefix.

5. If you want to change the name of the speed-dial entry, type the new name, and then touch **Done**.

Set up and change group speed-dial entries

You can store groups of fax numbers as group speed-dial entries.

To set up group speed-dial entries

 **NOTE:** Before you can create a group speed-dial entry, you must have already created at least one speed-dial entry.

1. On the printer's control panel, touch  (right arrow), and then touch **Setup**.
2. Touch **Fax Setup**, and then select **Speed Dial Setup**.
3. Touch **Group Speed Dial**, and then touch an unused entry number.
4. Touch the speed-dial entries you want to include in the group speed-dial entry, and then touch **OK**.
5. Type the name for the speed-dial entry, and then touch **Done**.

To change group speed-dial entries

1. On the printer's control panel, touch  (right arrow), and then touch **Setup**.
2. Touch **Fax Setup**, and then select **Speed Dial Setup**.
3. Select **Group Speed Dial**, and then touch the entry you want to change.
4. If you want to add or remove speed-dial entries from the group, touch the speed-dial entries you want to include or those you want to remove, and then touch **OK**.
5. If you want to change the name of the group speed-dial, type the new name, and then touch **Done**.

Delete speed-dial entries

To delete speed-dial entries or group speed-dial entries, complete the following steps:

1. On the printer's control panel, touch  (right arrow), and then touch **Setup**.
2. Touch **Fax Setup**, and then touch **Speed Dial Setup**.
3. Touch **Delete Speed Dial**, touch the entry you want to delete, and then touch **Yes** to confirm.

 **NOTE:** Deleting a group speed-dial entry does not delete the individual speed-dial entries.

Print a list of speed-dial entries

To print a list of all of the speed-dial entries that have been set up, complete the following steps:

1. Load paper in the tray. For more information, see [Load media](#).
2. On the printer's control panel, touch  (right arrow), and then touch **Setup**.
3. Touch **Fax Setup**, and then touch **Speed Dial Setup**.
4. Touch **Print Speed Dial List**.

Change fax settings

After completing the steps in the getting started guide that came with the printer, use the following steps to change the initial settings or to configure other options for faxing.

- [Configure the fax header](#)
- [Set the answer mode \(Auto answer\)](#)
- [Set the number of rings before answering](#)
- [Change the answer ring pattern for distinctive ring](#)
- [Set the dial type](#)
- [Set the redial options](#)
- [Set the fax speed](#)
- [Set the fax sound volume](#)

Configure the fax header

The fax header prints your name and fax number on the top of every fax you send. HP recommends that you set up the fax header by using the HP software provided with the printer. You can also set up the fax header from the printer control panel, as described here.

 **NOTE:** In some countries/regions, the fax header information is a legal requirement.

To set or change the fax header

1. Touch  (right arrow), and then touch **Setup**.
2. Touch **Fax Setup**, and then touch **Basic Fax Setup**.
3. Touch **Fax Header**.
4. Enter your personal or company name, and then touch **Done**.
5. Enter your fax number, and then touch **Done**.

Set the answer mode (Auto answer)

The answer mode determines whether the printer answers incoming calls.

- Turn on the **Auto Answer** setting if you want the printer to answer faxes **automatically**. The printer answers all incoming calls and faxes.
- Turn off the **Auto Answer** setting if you want to receive faxes **manually**. You must be available to respond in person to the incoming fax call or else the printer does not receive faxes.

To set the answer mode

1. Touch , and then touch **Setup**.
2. Touch **Fax Setup**, and then touch **Basic Fax Setup**.
3. Touch **Auto Answer**, and then select **On** or **Off**.



Set the number of rings before answering

If you turn on the **Auto Answer** setting, you can specify how many rings occur before incoming calls are automatically answered.

The **Rings to Answer** setting is important if you have an answering machine on the same phone line as the printer, because you want the answering machine to answer the phone before the printer does. The number of rings to answer for the printer should be greater than the number of rings to answer for the answering machine.

For example, set your answering machine to a low number of rings and the printer to answer in the maximum number of rings. (The maximum number of rings varies by country/region.) In this setup, the answering machine answers the call and the printer monitors the line. If the printer detects fax tones, it receives the fax. If the call is a voice call, the answering machine records the incoming message.

To set the number of rings before answering

1. Touch , and then touch **Setup**.
2. Touch **Fax Setup**, and then touch **Basic Fax Setup**.
3. Touch **Rings to Answer**.
4. Touch  (up arrow) or  (down arrow) to change the number of rings.
5. Touch **Done** to accept the setting.

Change the answer ring pattern for distinctive ring

Many phone companies offer a distinctive ring feature that allows you to have several phone numbers on one phone line. When you subscribe to this service, each number is assigned a different ring pattern. You can set up the printer to answer incoming calls that have a specific ring pattern.

If you connect the printer to a line with distinctive ring, have your telephone company assign one ring pattern to voice calls and another ring pattern to fax calls. HP recommends that you request double or triple rings for a fax number. When the printer detects the specified ring pattern, it answers the call and receives the fax.

 **TIP:** You can also use the Ring Pattern Detection feature in the printer's control panel to set distinctive ring. With this feature, the printer recognizes and records the ring pattern of an incoming call and, based on this call, automatically determines the distinctive ring pattern assigned by your telephone company to fax calls.

If you do not have a distinctive ring service, use the default ring pattern, which is **All Rings**.

 **NOTE:** The printer cannot receive faxes when the main phone number is off the hook.

To change the answer ring pattern for distinctive ring

1. Verify that the printer is set to answer fax calls automatically.
2. Touch  (right arrow), and then touch **Setup**.
3. Touch **Fax Setup**, and then select **Advanced Fax Setup**.
4. Touch **Distinctive Ring**.
5. A message appears stating that this setting should not be changed unless you have multiple numbers on the same telephone line. Touch **Yes** to continue.
6. Do one of the following:
 - Touch the ring pattern assigned by your telephone company to fax calls.
- Or -
 - Touch **Ring Pattern Detection**, and then follow the instructions on the printer's control panel.

 **NOTE:** If the Ring Pattern Detection feature cannot detect the ring pattern or if you cancel the feature before it finishes, the ring pattern is automatically set to the default, which is **All Rings**.



NOTE: If you are using a PBX phone system that has different ring patterns for internal and external calls, you must call the fax number from an external number.

Set the dial type

Use this procedure to set tone-dialing or pulse-dialing mode. The factory-set default is **Tone**. Do not change the setting unless you know that your phone line cannot use tone dialing.

 **NOTE:** The pulse-dialing option is not available in all countries/regions.

To set the dial type

1. Touch  (right arrow), and then touch **Setup**.
2. Touch **Fax Setup**, and then touch **Basic Fax Setup**.
3. Touch  (down arrow), and then touch **Tone or Pulse Dialing**.
4. Touch to select **Tone Dialing** or **Pulse Dialing**.

Set the redial options

If the printer was unable to send a fax because the receiving fax machine did not answer or was busy, the printer attempts to redial based on the settings for the busy-redial and no-answer-redial options. Use the following procedure to turn the options on or off.

- **Busy redial:** If this option is turned on, the printer redials automatically if it receives a busy signal. The factory-set default for this option is **On**.
- **No answer redial:** If this option is turned on, the printer redials automatically if the receiving fax machine does not answer. The factory-set default for this option is **Off**.

To set the redial options

1. Touch  (right arrow), and then touch **Setup**.
2. Touch **Fax Setup**, and then touch **Advanced Fax Setup**.
3. Touch **Busy Redial** or **No Answer Redial**, and then select the appropriate options.

Set the fax speed

You can set the fax speed used to communicate between your printer and other fax machines when sending and receiving faxes.

If you use one of the following, setting the fax speed to a slower speed might be required:

- An Internet phone service
- A PBX system
- Fax over Internet Protocol (FoIP)
- An integrated services digital network (ISDN) service

If you experience problems sending and receiving faxes, try using a lower **Fax Speed**. The following table provides the available fax speed settings.

Fax speed setting	Fax speed
Fast	v.34 (33600 baud)
Medium	v.17 (14400 baud)
Slow	v.29 (9600 baud)

To set the fax speed

1. Touch  (right arrow), and then touch **Setup**.
2. Touch **Fax Setup**, and then touch **Advanced Fax Setup**.
3. Touch **Fax Speed**.
4. Touch to select an option.

Set the fax sound volume

Use this procedure to increase or decrease the volume of the fax sounds.

To set the fax sound volume

1. Touch  (right arrow), and then touch **Setup**.
2. Touch **Fax Setup**, and then touch **Basic Fax Setup**.
3. Touch **Fax Sound Volume**.
4. Touch to select **Soft**, **Loud**, or **Off**.

Fax and digital phone services

Many telephone companies provide their customers with digital phone services, such as the following:

- DSL: A Digital subscriber line (DSL) service through your telephone company. (DSL might be called ADSL in your country/region.)
- PBX: A private branch exchange (PBX) phone system.
- ISDN: An integrated services digital network (ISDN) system.
- FoIP: A low-cost phone service that allows you to send and receive faxes with your printer by using the Internet. This method is called Fax over Internet Protocol (FoIP). For more information, see [Fax over Internet Protocol](#).

HP printers are designed specifically for use with traditional analog phone services. If you are in a digital phone environment (such as DSL/ADSL, PBX, or ISDN), you might need to use digital-to-analog filters or converters when setting up the printer for faxing.

 **NOTE:** HP does not guarantee that the printer will be compatible with all digital service lines or providers, in all digital environments, or with all digital-to-analog converters. It is always recommended that you discuss with the telephone company directly for the correct setup options based on their line services provided.

Fax over Internet Protocol

You might be able to subscribe to a low cost phone service that allows you to send and receive faxes with your printer by using the Internet. This method is called Fax over Internet Protocol (FoIP).

You probably use a FoIP service (provided by your telephone company) when you:

- Dial a special access code along with the fax number, or
- Have an IP converter box that connects to the Internet and provides analog phone ports for the fax connection.

 **NOTE:** You can only send and receive faxes by connecting a phone cord to the port labeled "1-LINE" on the printer. This means that your connection to the Internet must be done either through a converter box (which supplies regular analog phone jacks for fax connections) or your telephone company.

 **TIP:** Support for traditional fax transmission over any Internet protocol telephone systems are often limited. If you experience problems faxing, try using a slower fax speed or disabling the fax error-correction mode (ECM). However, if you turn off ECM, you cannot send and receive color faxes. (For more information about changing the fax speed, see [Set the fax speed](#). For more information about using ECM, see [Send a fax in Error Correction Mode](#).)

If you have questions about Internet faxing, contact your Internet faxing services support department or your local service provider for further assistance.

Use reports

You can set up the printer to print error reports and confirmation reports automatically for each fax you send and receive. You can also manually print system reports as required; these reports provide useful system information about the printer.

By default, the printer is set to print a report only if there is a problem sending or receiving a fax. A confirmation message that indicates whether a fax was successfully sent appears briefly on the control panel display after each transaction.

 **NOTE:** If the reports are not legible, you can check the estimated ink levels from the control panel or the HP software. For more information, see [Printer management tools](#).

NOTE: Ink level alerts and indicators provide estimates for planning purposes only. When you receive a low-ink alert, consider having a replacement cartridge available to avoid possible printing delays. You do not need to replace the ink cartridges until prompted to do so.

NOTE: Ensure that the printheads and ink cartridges are in good conditions and installed properly. For more information, see [Work with ink cartridges](#).

This section contains the following topics:

- [Print fax confirmation reports](#)
- [Print fax error reports](#)
- [Print and view the fax log](#)
- [Clear the fax log](#)
- [Print the details of the last fax transaction](#)
- [Print a Caller ID Report](#)
- [View the Call History](#)

Print fax confirmation reports

If you require printed confirmation that your faxes were successfully sent, follow these instructions to enable fax confirmation **before** sending any faxes. Select either **On (Fax Send)** or **On (Send and Receive)**.

The default fax confirmation setting is **Off**. This means that a confirmation report is not printed for each fax sent or received. A confirmation message indicating whether a fax was successfully sent appears briefly on the control panel display after each transaction.

 **NOTE:** You can include an image of the first page of the fax on the Fax Sent Confirmation report if you select **On (Fax Send)** or **On (Send and Receive)**, and if you scan the fax to send from memory or use the **Scan and Fax** option.

To enable fax confirmation

1. Touch  (right arrow), and then touch **Setup**.
2. Touch **Fax Setup**, and then touch **Fax Reports**.

3. Touch **Fax Confirmation**.
4. Touch to select one of the following options.

Off	Does not print a fax confirmation report when you send and receive faxes successfully. This is the default setting.
On (Fax Send)	Prints a fax confirmation report for every fax you send.
On (Fax Receive)	Prints a fax confirmation report for every fax you receive.
On (Send and Receive)	Prints a fax confirmation report for every fax you send and receive.

To include an image of the fax on the report

1. Touch , and then touch **Setup**.
2. Touch **Fax Reports**, and then touch **Fax Confirmation**.
3. Touch **On (Fax Send)** or **On (Send and Receive)**.
4. Touch **Fax Confirmation with image**.

Print fax error reports

You can configure the printer so that it automatically prints a report when there is an error during transmission or reception.

To set the printer to print fax error reports automatically

1. Touch , and then touch **Setup**.
2. Touch **Fax Setup**, and then touch **Fax Reports**.
3. Touch **Fax Error Report**.
4. Touch to select one of the following.

On (Send and Receive)	Prints whenever a fax error occurs.
Off	Does not print any fax error reports.
On (Fax Send)	Prints whenever a transmission error occurs. This is the default setting.
On (Fax Receive)	Prints whenever a receiving error occurs.

Print and view the fax log

You can print a log of faxes that have been received and sent by the printer.

To print the fax log from the printer control panel

1. Touch , and then touch **Setup**.
2. Touch **Fax Setup**, and then touch **Fax Reports**.
3. Touch **Fax Log**.

Clear the fax log

Use the following steps to clear the fax log.



NOTE: Clearing the fax log also deletes all faxes stored in memory.

To clear the fax log

1. Touch , and then touch **Setup**.
2. Do one of the following:
 - Touch **Tools**.
 - Or -
 - Touch **Fax Setup**, and then touch **Fax Tools**.
3. Touch **Clear Fax Log**.

Print the details of the last fax transaction

The Last Fax Transaction report prints the details of the last fax transaction to occur. Details include the fax number, number of pages, and the fax status.

To print the Last Fax Transaction report

1. Touch , and then touch **Setup**.
2. Touch **Fax Setup**, and then touch **Fax Reports**.
3. Touch **Last Transaction**.

Print a Caller ID Report

Use the following procedure to print a list of Caller ID fax numbers.

To print a Caller ID History Report

1. Touch , and then touch **Setup**.
2. Touch **Fax Setup**, and then touch **Fax Reports**.
3. Touch **Caller ID Report**.



View the Call History

Use the following procedure to view a list of all the calls placed from the printer.



NOTE: The call history cannot be printed. You can only view it from the printer's control panel display.

To view the Call History

1. Touch , and then touch **Fax**.
2. Touch  (Call History).

6 Web Services

The printer offers innovative, web-enabled solutions that can help you quickly access the Internet, obtain documents, and print them faster and with less hassle—and all without using a computer.

 **NOTE:** To use these web features, the printer must be connected to the Internet using a wireless connection. You cannot use these web features if the printer is connected using a USB cable.

This section contains the following topics:

- [What are Web Services?](#)
- [Set up Web Services](#)
- [Use Web Services](#)
- [Remove Web Services](#)

What are Web Services?

The printer includes the following Web Services:

HP ePrint

HP ePrint is a free service from HP that allows you to print to your HP ePrint-enabled printer anytime, from any location. It's as simple as sending an email to the email address assigned to your printer when you enable Web Services on the printer. No special drivers or software are needed. If you can send an email, you can print from anywhere, using HP ePrint.

Once you have signed up for an account on ePrintCenter, you can sign in to view your HP ePrint job status, manage your HP ePrint printer queue, control who can use your printer's HP ePrint email address to print, and get help for HP ePrint.

Printer Apps

Printer Apps allow you to easily locate and print preformatted web content, directly from your printer. You can also scan and store your documents digitally on the Web.

Printer Apps provide a wide range of content, from store coupons to family activities, news, travel, sports, cooking, photos, and many more. You can even view and print your online images from popular photo sites

Certain Printer Apps also allow you to schedule the delivery of app content to your printer.

Pre-formatted content designed specifically for your printer means no cut-off text and pictures and no extra pages with only one line of text. On some printers, you can also choose paper and print quality settings on the print preview screen.

All without even having to turn on your computer!

Set up Web Services

To set up Web Services, complete the following steps.

 **NOTE:** Before you set up Web Services, make sure you are connected to the Internet using a wireless connection.

Set up Web Services using the HP printer software

In addition to enabling key printer features, you can use the HP printer software that came with your printer to set up Web Services. If you didn't set up Web Services when you installed the HP software on your computer, you can still use the software to set up Web Services.

To set up Web Services, complete the following steps for your operating system:

Windows:

1. From the computer desktop, click **Start**, select **Programs** or **All Programs**, click **HP**, click the folder for your printer, and then select the icon with your printer's name.
2. Double-click **Web Connected Solutions**, and then double-click **ePrint Setup**. The printer's embedded web server opens.
3. On the **Web Services** tab, click **Setup** in the **Web Services Settings** section.
4. Click **Accept Terms of Use and Enable Web Services**, and then click **Next**.
5. Click **Yes** to allow the printer to automatically check for and install product updates.
6. If your network uses proxy settings when connecting to the Internet, enter these settings.
7. Follow the instructions on the Web Services information sheet to finish the setup.



Mac OS X:

To set up and manage Web Services in Mac OS X, you can use the printer's embedded web server (EWS). For more information, see [Set up Web Services using the embedded web server](#)

Set up Web Services using the printer's control panel

The printer's control panel provides an easy way to set up and manage Web Services.

To set up Web Services, complete the following steps:

1. Make sure the printer is connected to the Internet.
2. On the printer control panel, touch  (Apps) or  (HP ePrint).
3. Touch **Accept** to accept the Web Services terms of use and enable Web Services.
4. In the **Auto Update** screen, touch **Yes** to allow the printer to automatically check for and install product updates.

5. If your network uses proxy settings when connecting to the Internet, enter these settings:
 - a. Touch **Enter Proxy**.
 - b. Enter the proxy server settings, and then touch **Done**.
6. Follow the instructions on the Web Services information sheet to finish the setup.

Set up Web Services using the embedded web server

You can use the printer's embedded web server (EWS) to set up and manage Web Services.

To set up Web Services, complete the following steps:

1. Open the EWS. For more information, see [Embedded web server](#).
2. On the **Web Services** tab, click **Setup** in the **Web Services Settings** section.
3. Click **Accept Terms of Use and Enable Web Services**, and then click **Next**.
4. Click **Yes** to allow the printer to automatically check for and install product updates.
5. If your network uses proxy settings when connecting to the Internet, enter these settings.
6. Follow the instructions on the Web Services information sheet to finish the setup.

Use Web Services

The following section describes how to use and configure Web Services.

HP ePrint

HP ePrint allows you to print to your HP ePrint-enabled printer anytime, from any location.

To use HP ePrint, make sure to have the following:

- An Internet- and email-capable computer or mobile device
- An HP ePrint-capable printer on which Web Services has been enabled

 **TIP:** For more information about managing and configuring HP ePrint settings and to learn about the latest features, visit ePrintCenter at www.eprintcenter.com.

Print using HP ePrint

To print documents using HP ePrint, complete the following steps:

1. On your computer or mobile device, open your email application.



NOTE: For information about using the email application on your computer or mobile device, see the documentation provided with the application.

2. Create a new email message, and then attach the file that you want to print. For a list of files that can be printed using HP ePrint, as well as guidelines to follow when using HP ePrint, see [Web Services](#) and [HP website specifications](#).
3. Enter the printer's email address in the "To" line of the email message, and then select the option to send the email message.

 **NOTE:** Make sure that the printer's email address is the only address listed in the "To" line of the email message. If other email addresses are listed in the "To" line, the attachments you are sending might not print.

Find the printer's email address

To display your printer's HP ePrint email address, complete the following steps:

From the Home screen, touch  (HP ePrint).

The email address for the printer appears on the display.

 **TIP:** To print the email address, touch **Print**.

Turn off HP ePrint

To turn off HP ePrint, complete the following steps:

1. From the Home screen, touch  (HP ePrint), and then touch **Settings**.
2. Touch **ePrint**, and then touch **Off**.

 **NOTE:** To remove all Web Services, see [Remove Web Services](#).

Printer Apps

Printer Apps allow you to easily locate and print pre-formatted web content, directly from your printer.

Use Printer Apps

To use the Printer Apps on your printer, touch Apps on the printer's control panel display, and then touch the Print App you want to use.

For more information about individual Printer Apps, visit www.eprintcenter.com.

Manage Printer Apps

You can manage your Printer Apps with ePrintCenter. You can add, configure, or remove Printer Apps, and set the order in which they appear on your printer's display.

 **NOTE:** To manage Printer Apps from ePrintCenter, create an account on ePrintCenter and add your printer. For more information, visit www.eprintcenter.com.

Turn off Printer Apps

To turn off Printer Apps, complete the following steps:

1. From the Home screen, touch  (HP ePrint), and then touch **Settings**.
2. Touch **Apps**, and then touch **Off**.



NOTE: To remove all Web Services, see [Remove Web Services](#).

Remove Web Services

To remove Web Services, complete the following steps:

1. On the printer's control panel display, touch  (HP ePrint), and then touch **Settings**.
2. Touch **Remove Web Services**.

7 Work with ink cartridges

To ensure the best print quality from the printer, you need to perform some simple maintenance procedures. This section provides guidelines for handling the ink cartridges, instructions for replacing the ink cartridges, and aligning and cleaning the printhead.

 **TIP:** If you have problems copying documents, see [Print quality troubleshooting](#).

This section contains the following topics:

- [Information on ink cartridges and the printhead](#)
- [Check the estimated ink levels](#)
- [Printing with black or color ink only](#)
- [Replace the ink cartridges](#)
- [Store printing supplies](#)
- [Usage information collection](#)

Information on ink cartridges and the printhead

The following tips help maintain HP ink cartridges and ensure consistent print quality.

- The instructions in this user guide are for replacing ink cartridges, and are not intended for first time installation.
- Keep all ink cartridges in the original sealed packages until they are needed.
- Be sure to turn off the printer properly. For more information, see [Turn off the printer](#).
- Store ink cartridges at room temperature (15-35° C or 59-95° F).
- Do not clean the printhead unnecessarily. This wastes ink and shortens the life of the cartridges.
- Handle ink cartridges carefully. Dropping, jarring, or rough handling during installation can cause temporary printing problems.
- If you are transporting the printer, do the following to prevent ink leaking from the printer or other damage from occurring to the printer:
 - Make sure you turn off the printer by pressing  (Power) button. Wait until all sounds of internal motion stop before unplugging the printer. For more information, see [Turn off the printer](#).
 - Make sure you leave the ink cartridges installed.
 - The printer must be transported sitting flat; it should not be placed on its side, back, front, or top.

 **CAUTION:** HP recommends that you replace any missing cartridges as soon as possible to avoid print quality issues and possible extra ink usage or damage to the ink system. Never turn off the printer when ink cartridges are missing.

Related topics

[Check the estimated ink levels](#)

Check the estimated ink levels

You can check the estimated ink levels from the printer software or from the printer control panel. For information about using these tools, see [Printer management tools](#) and [Use the printer control panel](#). You can also print the Printer Status page to view this information (see [Understand the Printer Status Report](#)).

 **NOTE:** Ink level alerts and indicators provide estimates for planning purposes only. When you receive a low-ink alert, consider having a replacement cartridge available to avoid possible printing delays. You do not have to replace the cartridges until prompted to do so.

NOTE: If you have installed a refilled or remanufactured cartridge, or a cartridge that has been used in another printer, the ink level indicator might be inaccurate or unavailable.

NOTE: Ink from the cartridges is used in the printing process in a number of different ways, including in the initialization process, which prepares the printer and cartridges for printing, and in printhead servicing, which keeps print nozzles clear and ink flowing smoothly. In addition, some residual ink is left in the cartridge after it is used. For more information, see www.hp.com/go/inkusage.

Printing with black or color ink only

For regular usage, this product is not designed to print using only the black cartridge when the color cartridges are out of ink.

However, your printer is designed to let you print as long as possible when your cartridges start to run out of ink.

When there is sufficient ink in the printhead, the printer will offer you the use of black ink only when one or more of the color cartridges are out of ink, and the use of color ink only when the black cartridge is out of ink.

- The amount that you can print using black or color ink only is limited, so have replacement ink cartridges available when you are printing with black or color ink only.
- When there is no longer sufficient ink to print, you will get a message that one or more cartridges are depleted, and you will need to replace the depleted cartridges before you resume printing.

 **CAUTION:** While ink cartridges are not damaged when left outside of the printer, the printhead does need to have all cartridges installed at all times after the printer is set up and in use. Leaving one or more cartridge slots empty for an extended period may lead to print quality problems and possibly damage the printhead. If you have recently left a cartridge out of the printer for an extended period, or if you have had a recent paper jam, and have noticed poor print quality, clean the printhead. For more information, see [Clean the printhead](#).

Replace the ink cartridges

 **NOTE:** For information on recycling used ink supplies, see [HP inkjet supplies recycling program](#).

If you do not already have replacement ink cartridges for the printer, see [HP supplies and accessories](#).

 **NOTE:** At this time, some portions of the HP web site are available in English only.

NOTE: Not all cartridges are available in all countries/regions.

 **CAUTION:** HP recommends that you replace any missing cartridges as soon as possible to avoid print quality issues and possible extra ink usage or damage to the ink system. Never turn off the printer when ink cartridges are missing.

To replace the ink cartridges

Use these steps to replace the ink cartridges.

1. Make sure the printer is turned on.
2. Open the ink cartridge access door.

 **NOTE:** Wait until the print carriage stops moving before proceeding.

3. Press the front of the ink cartridge to release it, and then remove it from the slot.

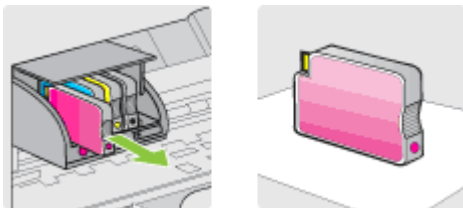

4. Remove the new ink cartridge from its packaging.
5. Using the color-coded letters for help, slide the ink cartridge into the empty slot until it is securely installed in the slot.

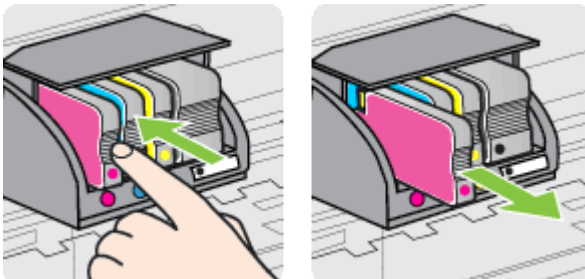

Make sure that you insert the ink cartridge into the slot that has the same colored letter as the color you are installing.



6. Repeat steps 3 through 5 for each ink cartridge you are replacing.
7. Close the print-carriage access door.

Related topics

[HP supplies and accessories](#)

Store printing supplies

Ink cartridges can be left in the printer for extended periods of time. However, to assure optimal ink cartridge health, be sure to turn off the printer properly. For more information, see [Turn off the printer](#).

Usage information collection

The HP cartridges used with this printer contain a memory chip that assists in the operation of the printer.

In addition, this memory chip collects a limited set of information about the usage of the printer, which might include the following: the date when the cartridge was first installed, the date when the cartridge was last used, the number of pages printed using the cartridge, the page coverage, the printing modes used, any printing errors that might have occurred, and the printer model. This information helps HP design future printers to meet our customers' printing needs.

The data collected from the cartridge memory chip does not contain information that can be used to identify a customer or user of the cartridge or their printer.

HP collects a sampling of the memory chips from cartridges returned to HP's free return and recycling program (HP Planet Partners: www.hp.com/recycle). The memory chips from this sampling are read and studied in order to improve future HP printers. HP partners who assist in recycling this cartridge might have access to this data, as well.

Any third party possessing the cartridge might have access to the anonymous information on the memory chip. If you prefer to not allow access to this information, you can render the chip inoperable. However, after you render the memory chip inoperable, the cartridge cannot be used in an HP printer.

If you are concerned about providing this anonymous information, you can make this information inaccessible by turning off the memory chip's ability to collect the printer's usage information:

To turn off usage information collection

1. On the printer control panel, touch  (right arrow), and then touch **Setup**.
2. Select **Preferences**, and then touch **Cartridge Chip Information**.
3. Touch **OK** to turn off usage information collection.

 **NOTE:** If you turn off the memory chip's ability to collect the printer's usage information, you can still continue to use the cartridge in the HP printer.

8 Solve a problem

The information in this section suggests solutions to common problems. If your printer is not operating correctly and these suggestions did not solve your problem, try using one of the following support services to obtain assistance.

This section contains the following topics:

- [HP support](#)
- [General troubleshooting tips and resources](#)
- [Solve printer problems](#)
- [Print quality troubleshooting](#)
- [Solve paper-feed problems](#)
- [Solve copy problems](#)
- [Solve scan problems](#)
- [Solve fax problems](#)
- [Solve problems using Web Services and HP websites](#)
- [Solve wireless problems](#)
- [Configure your firewall software to work with the printer](#)
- [Solve printer management problems](#)
- [Troubleshoot installation issues](#)
- [Understand the Printer Status Report](#)
- [Understand the network configuration page](#)
- [Clear jams](#)

HP support

If you have a problem, follow these steps

1. Check the documentation that came with the printer.
2. Visit the HP online support web site at www.hp.com/go/customer-care. This website provides information and utilities that can help you correct many common printer problems. HP online support is available to all HP customers. It is the fastest source for up-to-date printer information and expert assistance and includes the following features:
 - Fast access to qualified online support specialists
 - HP software and driver updates for the HP printer
 - Valuable troubleshooting information for common problems
 - Proactive printer updates, support alerts, and HP newsletters that are available when you register the printerFor more information, see [Obtain electronic support](#).
3. Call HP support. Support options and availability vary by printer, country/region, and language. For more information, see [HP support by phone](#).

Obtain electronic support

To find support and warranty information, go to the HP web site at www.hp.com/go/customercare. This website provides information and utilities that can help you correct many common printer problems. If prompted, select your country/region, and then click **Contact HP** for information about calling for technical support.

This web site also offers technical support, drivers, supplies, ordering information and other options such as:

- Access online support pages.
- Send HP an email message for answers to your questions.
- Connect with an HP technician by using online chat.
- Check for HP software updates.

You can also obtain support from the HP software for Windows or Mac OS X, which provide easy, step-by-step solutions to common printing problems. For more information, see [Printer management tools](#).

Support options and availability vary by printer, country/region, and language.

HP support by phone

The phone support numbers and associated costs listed here are those in effect at time of publication and are applicable only for calls made on a land line. Different rates may apply for mobile phones.

For the most current HP list of telephone support numbers and call costs information, see www.hp.com/go/customercare.

During the warranty period, you may obtain assistance from the HP Customer Care Center.

 **NOTE:** HP does not provide telephone support for Linux printing. All support is provided online at the following web site: <https://launchpad.net/hplip>. Click the **Ask a question** button to begin the support process.

The HPLIP web site does not provide support for Windows or Mac OS X. If you are using these operating systems, see www.hp.com/go/customercare.

This section contains the following topics:

- [Before you call](#)
- [Phone support period](#)
- [Telephone support numbers](#)
- [After the phone support period](#)

Before you call

Call HP support while you are in front of the computer and the printer. Be prepared to provide the following information:

- Model number (for more information, see [Find the printer model number](#))
- Serial number (located on the back or bottom of the printer)

- Messages that appear when the situation occurs
- Answers to these questions:
 - Has this situation happened before?
 - Can you re-create it?
 - Did you add any new hardware or software to your computer at about the time that this situation began?
 - Did anything else occur prior to this situation (such as a thunderstorm or moving the printer)?

Phone support period

One year of phone support is available in North America, Asia Pacific, and Latin America (including Mexico).

Telephone support numbers

In many locations, HP provides toll free telephone support during the warranty period. However, some of the support numbers might not be toll free.

For the most current list of telephone support numbers, see www.hp.com/go/customer-care. This website provides information and utilities that can help you correct many common printer problems.



www.hp.com/support

Africa (English speaking)	+27 11 2345872
Afrique (francophone)	+33 1 4993 9230
021 672 280	الجزائر
Algérie	021 67 22 80
Argentina (Buenos Aires)	54-11-4708-1600
Argentina	0-800-555-5000
Australia	1300 721 147
Australia (out-of-warranty)	1902 910 910
Österreich	+43 0820 87 4417 doppelter Ortstarif
17212049	البحرين
België	+32 078 600 019 Peak Hours: 0,055 € p/m Low Hours: 0,27 € p/m
Belgique	+32 078 600 020 Peak Hours: 0,055 €/m Low Hours: 0,27 €/m
Brasil (Sao Paulo)	55-11-4004-7751
Brasil	0-800-709-7751
Canada	1-(800)-474-6836 (1-800 hp invent)
Central America & The Caribbean	www.hp.com/la/sopoorte
Chile	800-360-999
中国	1068687980
中国	800-810-3888
Colombia (Bogotá)	571-606-9191
Colombia	01-8000-51-4746-8368
Costa Rica	0-800-011-1046
Česká republika	810 222 222 1.53 CZN/min
Danmark	+45 70 202 845 Opkald: 0,145 (kr. pr. min.) Pr. min. man-ter 08.00-19.30: 0,25 Pr. min. øvrige tidspunkter: 0,125
Ecuador (Andinatel)	1-999-119 ☎ 800-711-2884
Ecuador (Pacifitel)	1-800-225-528 ☎ 800-711-2884
(02) 6910602	مصر
El Salvador	800-6160
España	+34 902 010 059 0,94 € p/m
France	+33 0969 320 435
Deutschland	+49 01805 652 180 0,14 €/Min aus dem deutschen Festnetz - bei Anrufen aus Mobilfunknetzen können andere Preise gelten
Ελλάδα	801-11-75400
Κύπρος	+800 9 2654
Guatemala	1-800-711-2884
香港特別行政區	(852) 2802 4098
India	1-800-425-7737
India	91-80-28526900
Indonesia	+62 (21) 350 3408
+971 4 224 9189	العراق
+971 4 224 9189	الكويت
+971 4 224 9189	لبنان
+971 4 224 9189	قطر
+971 4 224 9189	اليمن
Ireland	+353 1890 923 902 Calls cost Cost 5.1 cent peak / 1.3 cent off-peak per minute
Italia	+39 848 800 871 costo telefonico locale
Jamaica	1-800-711-2884
日本	0120-96-1665

0800 222 47	الأردن
한국	1588-3003
Luxembourg (Français)	+352 900 40 006 0.15 €/min
Luxemburg (Deutsch)	+352 900 40 007 0.15 €/Min
Madagascar	262 262 51 21 21
Magyarország	06 40 200 629 7.2 HUF/perc vezetékes telefonra
Malaysia	1800 88 8588
Mauritius	262 262 210 404
México (Ciudad de México)	55-5258-9922
México	01-800-472-68368
Maroc	0801 005 010
Nederland	+31 0900 2020 165 0.10 €/Min
New Zealand	0800 441 147
Nigeria	(01) 271 2320
Norge	+47 815 62 070 starter på 0,59 Kr per min., deretter 0,39 Kr per min. Fra mobiltelefon gjelder mobiltelefonaktster.
24791773	عمان
Panamá	1-800-711-2884
Paraguay	009 800 54 1 0006
Perú	0-800-10111
Philippines	2 867 3551
Polska	(22) 583 43 73 Koszt połączenia: - z tel. stacjonarnego jak za 1 impuls wg taryfy operatora - z tel. komórkowego wg taryfy operatora.
Portugal	+351 808 201 492 Custo: 8 céntimos no primeiro minuto e 3 céntimos restantes minutos
Puerto Rico	1-877-232-0589
República Dominicana	1-800-711-2884
Reunion	0820 890 323
România	0801 033 390 (021 204 7090)
Россия (Москва)	495 777 3284
Россия (Санкт-Петербург)	812 332 4240
800 897 1415	السعودية
Singapore	+65 6272 5300
Slovenská republika	0850 111 256
South Africa (RSA)	0860 104 771
Suomi	+358 0 203 66 767
Sverige	+46 077 120 4765 0,23 kr/min
Switzerland	+41 0848 672 672 0,08 CHF/min.
臺灣	0800-010055 (免費)
ไทย	+66 (2) 353 9000
071 891 391	تونس
Trinidad & Tobago	1-800-711-2884
Tunisie	23 926 000
Türkiye (İstanbul, Ankara, İzmir & Bursa)	0(212) 444 0307 Yerel numara: 444 0307
Україна	(044) 230-51-06
600 54 47 47	الإمارات العربية المتحدة
United Kingdom	0844 369 0369 0.50 £ p/m
United States	1-(800)-474-6836
Uruguay	0004-054-177
Venezuela (Caracas)	58-212-278-8666
Venezuela	0-800-474-68368
Việt Nam	+84 882345HP support

After the phone support period

After the phone support period, help is available from HP at an additional cost. Help may also be available at the HP online support web site: www.hp.com/go/customer-care. This website provides information and utilities that can help you correct many common printer problems. Contact your HP dealer or call the support phone number for your country/region to learn more about support options.

General troubleshooting tips and resources

 **NOTE:** Many of the following steps require HP software. If you did not install the HP software, you can install it using the HP software CD included with the printer, or you can download the HP software from the HP support web site, www.hp.com/go/customer-care. This website provides information and utilities that can help you correct many common printer problems.

Check or do the following before you begin troubleshooting:

- Try turning the printer off and then on again.
- For a paper jam, see [Clear jams](#).
- For paper-feed problems, such as the paper skew and paper pick, see [Solve paper-feed problems](#).
- The  (Power button) light is on and is not blinking. When the printer is turned on for the first time, it takes approximately 9 minutes to initialize it after the ink cartridges are installed.
- The power cord and other cables are working, and are firmly connected to the printer. Make sure the printer is connected firmly to a functioning alternating current (AC) power outlet, and is turned on. For voltage requirements, see [Electrical specifications](#).
- Media is loaded correctly in the input tray and is not jammed in the printer.
- All packing tapes and materials are removed.
- The printer is set as the current or default printer. For Windows, set it as the default in the Printers folder. For Mac OS X, set it as the default in the **Print & Fax** or **Print & Scan** section of the **System Preferences**. See your computer's documentation for more information.
- **Pause Printing** is not selected if you are using a computer running Windows.
- You are not running too many programs when you are performing a task. Close programs that you are not using or restart the computer before attempting the task again.

Solve printer problems

This section contains the following topics:

- [The printer shuts down unexpectedly](#)
- [The printer is making some unexpected noises](#)
- [Alignment fails](#)
- [The printer is not responding \(nothing prints\)](#)
- [The printer prints slowly](#)

- [Blank or partial page printed](#)
- [Something on the page is missing or incorrect](#)
- [Placement of the text or graphics is wrong](#)

The printer shuts down unexpectedly

Check the power and power connections

Make sure the printer's power cord is connected firmly to a functioning power outlet. For voltage requirements, see [Electrical specifications](#).

The printer is making some unexpected noises

You might hear some unexpected noises made by the printer. These are the servicing sounds when the printer performs automatic servicing functions to maintain the health of the printheads.

 **NOTE:** To prevent any potential damage to your printer:

Do not turn off the printer while the printer is performing any servicing. If you are turning off the printer, wait for the printer to come to a complete stop before turning off using the  (Power) button. For more information, see [Turn off the printer](#).

Make sure all ink cartridges are installed. If any of the ink cartridge is missing, the printer will perform extra servicing to protect the printheads.

Alignment fails

If the alignment process fails, make sure you have loaded unused, plain white paper into the input tray. If you have colored paper loaded in the input tray when you align the ink cartridges, the alignment fails.

If the alignment process fails repeatedly, you may need to clean the printhead, or you might have a defective sensor. To clean the printhead, see [Clean the printhead](#).

If cleaning the printhead does not solve the problem, contact HP support. Go to www.hp.com/go/customer-care. This website provides information and utilities that can help you correct many common printer problems. If prompted, select your country/region, and then click **Contact HP** for information on calling for technical support.

The printer is not responding (nothing prints)

There are print jobs stuck in the print queue

Open the print queue, cancel all documents, and then reboot the computer. Try to print after the computer reboots. Refer to the Help system for the operating system for more information.

Check the printer setup

For more information, see [General troubleshooting tips and resources](#).

Check the HP software installation

If the printer is turned off when printing, an alert message should appear on your computer screen; otherwise, the HP software provided with the printer might not be

installed correctly. To resolve this, uninstall the HP software completely, and then reinstall the HP software. For more information, see [Uninstall and reinstall the HP software](#).

Check the cable connections

- Make sure both ends of the USB cable are secure.
- If the printer is connected to a network, check the following:
 - Check the Link light on the back of the printer.
 - Make sure you are not using a phone cord to connect the printer.

Check any personal firewall software installed on the computer

The personal software firewall is a security program that protects a computer from intrusion. However, the firewall might block communication between the computer and the printer. If there is a problem communicating with the printer, try temporarily disabling the firewall. If the problem persists, the firewall is not the source of the communication problem. Re-enable the firewall.

The printer prints slowly

Try the following solutions if the printer is printing very slowly.

- [Solution 1: Use a lower print quality setting](#)
- [Solution 2: Check the ink levels](#)
- [Solution 3: Contact HP support](#)

Solution 1: Use a lower print quality setting

Solution: Check the print quality setting. **Best** and **Maximum dpi** provide the best quality but are slower than **Normal** or **Draft**. **Draft** provides the fastest print speed.

Cause: The print quality was set to a high setting.

If this did not solve the issue, try the next solution.

Solution 2: Check the ink levels

Solution: Check the estimated ink levels in the ink cartridges.

 **NOTE:** Ink level alerts and indicators provide estimates for planning purposes only. When you receive a low on ink message, consider having a replacement cartridge available to avoid possible printing delays. You do not need to replace the ink cartridges until prompted to do so.

 **CAUTION:** While ink cartridges are not damaged when left outside of the printer, the printhead does need to have all cartridges installed at all times after the printer is set up and in use. Leaving one or more cartridge slots empty for an extended period may lead to print quality problems and possibly damage the printhead. If you have recently left a cartridge out of the printer for an extended period and have noticed poor print quality, clean the printhead. For more information, see [Clean the printhead](#).

For more information, see:

[Check the estimated ink levels](#)

Cause: The ink cartridges might have insufficient ink.

If this did not solve the issue, try the next solution.

Solution 3: Contact HP support

Solution: Contact HP support for service.

Go to: www.hp.com/go/customer-care. This website provides information and utilities that can help you correct many common printer problems.



If prompted, choose your country/region, and then click **Contact HP** for information on calling for technical support.

Cause: There was a problem with the printer.

Blank or partial page printed

Clean the printhead

Complete the printhead cleaning procedure. The printhead may need to be cleaned if the printer was turned off incorrectly.

 **NOTE:** Incorrectly turning off the printer can cause print quality problems like blank or partial pages. Printhead cleaning can solve these problems, but turning off the printer correctly can prevent them in the first place. Always turn the printer off by pressing the  (Power button) on the printer. Wait until the  (Power button) light goes out before unplugging the power cord or turning off a power strip.

Check the media settings

- Make sure you select the correct print quality settings in the printer driver for the media loaded in the trays.
- Make sure the page settings in the printer driver match the page size of media loaded in the tray.

More than one page is being picked

For more information on paper-feed problems, see [Solve paper-feed problems](#).

There is a blank page in the file

Check the file to make sure there is no blank page.

Something on the page is missing or incorrect

Check the Print Quality Diagnostic page

Print a Print Quality Diagnostic page to help you decide whether to run any maintenance tools to improve the print quality of your printouts. For more information, see [Understand the Printer Status Report](#).

Check the margin settings

Make sure the margin settings for the document do not exceed the printable area of the printer. For more information, see [Set minimum margins](#).

Check the color print settings

Make sure **Print in Grayscale** is not selected in the printer driver.

Check the printer location and length of USB cable

High electromagnetic fields (such as those generated by USB cables) can sometimes cause slight distortions to printouts. Move the printer away from the source of the electromagnetic fields. Also, it is recommended that you use a USB cable that is less than 3 meters (9.8 feet) long to minimize the effects of these electromagnetic fields.

Check the paper size

Make sure the selected paper size matches the actual loaded paper size.

Placement of the text or graphics is wrong

Check how the media is loaded

Make sure the media width and length guides fit snugly against the edges of the stack of media, and make sure the tray is not overloaded. For more information, see [Load media](#).

Check the media size

- Content on a page might be cut off if the document size is larger than the media that you are using.
- Make sure the media size selected in the printer driver match the size of media loaded in the tray.

Check the margin settings

If the text or graphics are cut off at the edges of the page, make sure the margin settings for the document do not exceed the printable area of your printer. For more information, see [Set minimum margins](#).

Check the page-orientation setting

Make sure the media size and page orientation selected in the application match the settings in the printer driver. For more information, see [Print](#).

Check the printer location and length of USB cable

High electromagnetic fields (such as those generated by USB cables) can sometimes cause slight distortions to printouts. Move the printer away from the source of the electromagnetic fields. Also, it is recommended that you use a USB cable that is less than 3 meters (9.8 feet) long to minimize the effects of these electromagnetic fields.

If the above solutions do not work, the problem may be caused by the inability of the application to interpret print settings correctly. See the release notes for known software conflicts, refer to the application's documentation, or contact the software manufacturer for specific help.

 **TIP:** If you are using a computer running Windows, you can visit the HP online support website at www.hp.com/go/customer-care. This website provides information and utilities that can help you correct many common printer problems.

Print quality troubleshooting

Try the solutions in this section to resolve print quality problems in your printout.

- [Solution 1: Make sure you are using original HP ink cartridges](#)
- [Solution 2: Check the ink levels](#)
- [Solution 3: Check the paper loaded in the input tray](#)
- [Solution 4: Check the paper type](#)
- [Solution 5: Check the print settings](#)
- [Solution 6: Print and evaluate a print quality report](#)
- [Solution 7: Contact HP support](#)

Solution 1: Make sure you are using original HP ink cartridges

Solution: Check to see if your ink cartridges are original HP ink cartridges.

HP recommends that you use original HP ink cartridges. Original HP ink cartridges are designed and tested with HP printers to help you easily produce great results, time after time.

 **NOTE:** HP cannot guarantee the quality or reliability of non-HP supplies. Printer service or repairs required as a result of using a non-HP supply are not covered under warranty.

If you believe you purchased original HP ink cartridges, go to:

www.hp.com/go/anticounterfeit

Cause: Non-HP ink cartridges were being used.

If this did not solve the issue, try the next solution.

Solution 2: Check the ink levels

Solution: Check the estimated ink levels in the ink cartridges.

 **NOTE:** Ink level alerts and indicators provide estimates for planning purposes only. When you receive a low-ink alert, consider having a replacement cartridge available to avoid possible printing delays. You do not need to replace the ink cartridges until prompted to do so.

 **CAUTION:** While ink cartridges are not damaged when left outside of the printer, the printhead does need to have all cartridges installed at all times after the printer is set up and in use. Leaving one or more cartridge slots empty for an extended period may lead to print quality problems and possibly damage the printhead. If you have recently left a cartridge out of the printer for an extended period, or if you have had a recent paper jam, and have noticed poor print quality, clean the printhead. For more information, see [Clean the printhead](#).

For more information, see:

[Check the estimated ink levels](#)

Cause: The ink cartridges might have insufficient ink.

If this did not solve the issue, try the next solution.

Solution 3: Check the paper loaded in the input tray

Solution: Make sure the paper is loaded correctly and that it is not wrinkled or too thick.

- Load paper with the print side facing down. For example, if you are loading glossy photo paper, load the paper with the glossy side down.
- Make sure the paper lays flat in the input tray and is not wrinkled. If the paper is too close to the printhead during printing, the ink might be smeared. This can happen if the paper is raised, wrinkled, or very thick, such as a mailing envelope.

For more information, see:

[Load media](#)

Cause: The paper was loaded incorrectly, or it was wrinkled or too thick.

If this did not solve the issue, try the next solution.

Solution 4: Check the paper type

Solution: HP recommends that you use HP papers or any other paper type with ColorLok technology that is appropriate for the printer. All papers with the ColorLok logo are independently tested to meet high standards of reliability and print quality, and produce documents with crisp, vivid color, bolder blacks and dry faster than ordinary plain papers.

Always make sure the paper you are printing on is flat. For best results when printing images, use HP Advanced Photo Paper.

Store specialty media in its original packaging inside a resealable plastic bag on a flat surface in a cool, dry place. When you are ready to print, remove only the

paper you plan to use immediately. When you have finished printing, return any unused photo paper to the plastic bag. This prevents the photo paper from curling.

 **NOTE:** For this issue, there is not a problem with your ink supplies. Therefore, replacing the ink cartridges is not necessary.

For more information, see:

[Select print media](#)

Cause: The wrong kind of paper was loaded in the input tray.

If this did not solve the issue, try the next solution.

Solution 5: Check the print settings

Solution: Check the print settings.

- Check the print settings to see if the color settings are incorrect. For example, check to see if the document is set to print in grayscale. Or, check to see if advanced color settings such as saturation, brightness, or color tone, are set to modify the appearance of colors.
- Check the print quality setting and make sure it matches the type of paper loaded in the printer. You might need to choose a lower print quality setting if colors are running into each other. Or, choose a higher setting if you are printing a high-quality photo, and then make sure photo paper such as HP Advanced Photo Paper is loaded in the input tray.

 **NOTE:** On some computer screens, colors might appear differently than they do when printed on paper. In this case, there is nothing wrong with the printer, print settings, or ink cartridges. No further troubleshooting is required.

For more information, see:

[Select print media](#)

Cause: The print settings were set incorrectly.

If this did not solve the issue, try the next solution.

Solution 6: Print and evaluate a print quality report

Solution:

To print a print quality report

- **Control panel:** Touch  (right arrow), touch **Setup**, touch **Reports**, and then touch **Print Quality Report**.
- **Embedded web server:** Click the **Tools** tab, click **Print Quality Toolbox** under **Utilities**, and then click the **Print Quality Report** button.
- **HP Utility (Mac OS X):** In the **Information And Support** section, click **Print Quality Diagnostics**, and then click **Print**.

HP Officejet 6800 e-All-in-One series
Print Quality Diagnostic Page

Printer Information

Product model number: CE863A
Product serial number: CMX801T10N05K0R
Service ID: 21324
Firmware Version: TGL4FA1106AR
Pages printed: Tray 1=14, Tray 2=0, Total=14, Auto-duplex unit=0
Ink cartridge level*: K=66, Y=90, M=60, C=60
*Estimates only. Actual ink levels may vary.

Test Pattern 1

If the lines are not straight and connected, align the printheads.



Test Pattern 2

If you see thin white lines across any of the colored blocks, clean the printheads.

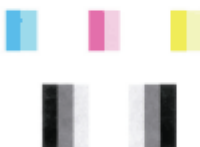

Test Pattern 3

If you see dark lines or white gaps where the arrows are pointing, align printhead.



If defects are seen on the Print Quality Diagnostic report, follow the steps below:

1. If the lines in Test Pattern 1 are not straight and connected, align the printer. For more information, see [Align the printhead](#).
2. If you see white lines in any of the color blocks in Test Pattern 2, clean the printhead. For more information, see [Clean the printhead](#).
3. If you see white or dark lines where the arrows are pointing in Test Pattern 3, align the printer. For more information, see [Align the printhead](#).

Cause: Print quality problems can have many causes: software settings, a poor image file, or the printing system itself. If you are unhappy with the quality of your prints, a Print Quality Diagnostic page can help you determine if the printing system is working correctly.

Solution 7: Contact HP support

Solution: Contact HP support for service.

If prompted, choose your country/region, and then click **Contact HP** for information on calling for technical support.

 **TIP:** If you are using a computer running Windows, you can visit the HP online support website at www.hp.com/go/customer-care. This website provides information and utilities that can help you correct many common printer problems.

Cause: There was a problem with the printhead.

Printhead maintenance

If you are experiencing problems with printing, you might have a problem with the printhead. You should perform the procedures in the following sections only when directed to do so for resolving print quality issues.

Performing the aligning and cleaning procedures unnecessarily can waste ink and shorten the life of the cartridges.

This section contains the following topics:

- [Clean the printhead](#)
- [Align the printhead](#)

Clean the printhead

If your printed output is streaked or has any incorrect or missing colors, the printhead might need to be cleaned.

There are two stages of cleaning. Each stage lasts about two minutes, uses one sheet of paper, and uses an increasing amount of ink. After each stage, review the quality of the printed page. You should only initiate the next phase of cleaning if the print quality is poor.

If print quality still seems poor after you complete both stages of cleaning, try aligning the printer. If print quality problems persist after cleaning and aligning, contact HP support. For more information, see [HP support](#).

 **NOTE:** Cleaning uses ink, so clean the printhead only when necessary. The cleaning process takes a few minutes. Some noise might be generated in the process. Before cleaning the printhead, make sure you load paper. For more information, see [Load media](#).

Not turning the printer off correctly can cause print quality problems. For more information, see [Turn off the printer](#).

To clean the printhead from the control panel

1. Load Letter, A4, or Legal unused plain white paper into the main input tray. For more information, see [Load standard-size media](#).
2. Touch  (right arrow), and then touch **Setup**.
3. Touch **Tools**, and then touch **Clean Printhead**.

To clean the printhead from Toolbox (Windows)

1. Load Letter, A4, or Legal unused plain white paper into the main input tray. For more information, see [Load standard-size media](#).
2. Open Toolbox. For more information, see [Open the Toolbox](#).

3. From the **Device Services** tab, click the icon to the left of **Clean Printheads**.
4. Follow the onscreen instructions.

To clean the printhead from HP Utility (Mac OS X)

1. Load Letter, A4, or Legal unused plain white paper into the main input tray. For more information, see [Load standard-size media](#).
2. Open HP Utility. For more information, see [HP Utility \(Mac OS X\)](#).
3. In the **Information And Support** section, click **Clean Printheads**.
4. Click **Clean**, and then follow the onscreen instructions.

To clean the printhead from the embedded web server (EWS)

1. Load Letter, A4, or Legal unused plain white paper into the main input tray. For more information, see [Load standard-size media](#).
2. Open the EWS. For more information, see [To open the embedded web server](#).
3. Click the **Tools** tab, and then click **Print Quality Toolbox** in the **Utilities** section.
4. Click **Clean Printhead** and follow the onscreen instructions.

Align the printhead

The printer automatically aligns the printhead during the initial setup.

You might want to use this feature when the printer status page shows streaking or white lines through any of the blocks of color or if you are having print quality issues with your printouts.

To align the printhead from the control panel

1. Load Letter, A4, or Legal unused plain white paper into the main input tray. For more information, see [Load standard-size media](#).
2. On the printer control panel, touch  (right arrow), and then touch **Setup**.
3. Touch **Tools**, and then select **Align Printer**.

To align the printhead from Toolbox (Windows)

1. Load Letter, A4, or Legal unused plain white paper into the main input tray. For more information, see [Load standard-size media](#).
2. Open Toolbox. For more information, see [Open the Toolbox](#).
3. From the **Device Services** tab, click the icon to the left of **Align Printheads**.
4. Follow the onscreen instructions.

To align the printhead from HP Utility (Mac OS X)

1. Load Letter, A4, or Legal unused plain white paper into the main input tray. For more information, see [Load standard-size media](#).
2. Open HP Utility. For more information, see [HP Utility \(Mac OS X\)](#).
3. In the **Information And Support** section, click **Align Printhead**.
4. Click **Align**, and then follow the onscreen instructions.

To align the printhead from the embedded web server (EWS)

1. Load Letter, A4, or Legal unused plain white paper into the main input tray. For more information, see [Load standard-size media](#).
2. Open the EWS. For more information, see [To open the embedded web server](#).
3. Click the **Tools** tab, and then click **Print Quality Toolbox** in the **Utilities** section.
4. Click **Align Printhead** and follow the onscreen instructions.

Solve paper-feed problems

 **TIP:** You can visit the HP online support website at www.hp.com/go/customer-care for information and utilities that can help you correct many common printer problems.

Media is not supported for the printer or tray

Use only media that is supported for the printer and the tray being used. For more information, see [Media specifications](#).

Media is not picked up from a tray

- Make sure media is loaded in the tray. For more information, see [Load media](#). Fan the media before loading.
- Make sure the paper guides are set to the correct markings in the tray for the media size you are loading. Also make sure the guides are snug, but not tight, against the stack.
- Make sure media in the tray is not curled. Uncurl paper by bending it in the opposite direction of the curl.

Media is not coming out correctly

- Make sure the output tray extender is fully extended; otherwise, printed pages may fall off the printer.

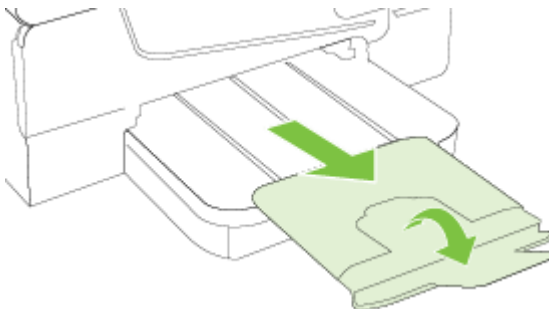

- Remove excess media from the output tray. There is a limit to the number of sheets the tray can hold.

Pages are skewing

- Make sure the media loaded in the trays is aligned to the paper guides. If needed, pull out the trays from the printer and reload the media correctly, making sure that the paper guides are aligned correctly.
- Load media into the printer only when it is not printing.

Multiple pages are being picked up

- Fan the media before loading.
- Make sure the paper guides are set to the correct markings in the tray for the media size you are loading. Also make sure the guides are snug, but not tight, against the stack.
- Make sure the tray is not overloaded with paper.
- Use HP media for optimum performance and efficiency.

Solve copy problems

If the following topics do not help, see [HP support](#) for information about HP support.

- [No copy came out](#)
- [Copies are blank](#)
- [Documents are missing or faded](#)
- [Size is reduced](#)
- [Copy quality is poor](#)
- [Copy defects are apparent](#)
- [The printer prints half a page, then ejects the paper](#)
- [Paper mismatch](#)

No copy came out

- **Check the power**
Make sure that the power cord is securely connected, and the printer turned on.
- **Check the status of the printer**
 - The printer might be busy with another job. Check the control panel display for information about the status of jobs. Wait for any job that is processing to finish.
 - The printer might be jammed. Check for jams. See [Clear jams](#).
- **Check the trays**
Make sure that media is loaded. For more information, see [Load media](#).

Copies are blank

- **Check the media**

The media might not meet Hewlett-Packard media specifications (for example, the media is too moist or too rough). For more information, see [Media specifications](#).
- **Check the settings**

The contrast setting might be set too light. On the printer control panel, touch **Copy**, touch **Lighter Darker**, and then use the arrows to create darker copies.
- **Check the trays**

If you are copying from the automatic document feeder (ADF), make sure that the originals have been loaded correctly. For more information, see [Load an original in the automatic document feeder \(ADF\)](#).

Documents are missing or faded

- **Check the media**

The media might not meet Hewlett-Packard media specifications (for example, the media is too moist or too rough). For more information, see [Media specifications](#).
- **Check the settings**

The quality setting of **Fast** (which produces draft-quality copies) might be responsible for the missing or faded documents. Change to the **Normal** or **Best** setting.
- **Check the original**
 - The accuracy of the copy depends on the quality and size of the original. Use the **Copy** menu to adjust the brightness of the copy. If the original is too light, the copy might not be able to compensate, even if you adjust the contrast.
 - Colored backgrounds might cause images in the foreground to blend into the background, or the background might appear in a different shade.
 - If you are copying a borderless original, load the original on the scanner glass, not the ADF. For more information, see [Load an original on the scanner glass](#).
 - If you are copying a photo, be sure to load it on the scanner glass as indicated by the icon on the scan bed.

Size is reduced

- The reduce/enlarge or other copy feature might have been set from the printer control panel to reduce the scanned image. Check the settings for the copy job to make sure that they are for normal size.
- The HP software settings might be set to reduce the scanned image. Change the settings, if needed. For more information, see the onscreen Help for the HP software.

Copy quality is poor

- **Take steps to improve the copy quality**
 - Use quality originals.
 - Load the media correctly. If the media is loaded incorrectly, it might skew, causing unclear images. For more information, see [Media specifications](#).
 - Use or make a carrier sheet to protect your originals.
- **Check the printer**
 - The scanner lid might not be closed correctly.
 - The scanner glass or lid backing might need cleaning. For more information, see [Maintain the printer](#).
 - The automatic document feeder (ADF) might need cleaning. For more information, see [Maintain the printer](#).
- Print a Print Quality Diagnostic Page and follow the instruction on the page to resolve poor quality copy problems. For more information, see [Print quality troubleshooting](#).

Copy defects are apparent

- **Vertical white or faded stripes**

The media might not meet Hewlett-Packard media specifications (for example, the media is too moist or too rough). For more information, see [Media specifications](#).
- **Too light or dark**

Try adjusting the contrast and copy-quality settings.
- **Unwanted lines**

The scanner glass, lid backing, or frame might need cleaning. For more information, see [Maintain the printer](#).
- **Black dots or streaks**

Ink, glue, correction fluid, or an unwanted substance might be on the scanner glass or lid backing. Try cleaning the printer. For more information, see [Maintain the printer](#).
- **Copy is slanted or skewed**

If you are using the automatic document feeder (ADF), check the following:

 - Make sure that the ADF input tray is not too full.
 - Make sure that the ADF width adjusters are snug against the sides of the media.

For more information, see [Load an original in the automatic document feeder \(ADF\)](#).
- **Unclear text**
 - Try adjusting the contrast and copy-quality settings.
 - The default enhancement setting might not be suitable for the job. Check the setting and change it to enhance text or photographs, if needed. For more information, see [Change copy settings](#).
- **Incompletely filled text or graphics**

Try adjusting the contrast and copy-quality settings.

- **Large, black typefaces look splotchy (not smooth)**
The default enhancement setting might not be suitable for the job. Check the setting and change it to enhance text or photographs, if needed. For more information, see [Change copy settings](#).
- **Horizontal grainy or white bands in light-gray to medium-gray areas**
The default enhancement setting might not be suitable for the job. Check the setting and change it to enhance text or photographs, if needed. For more information, see [Change copy settings](#).

The printer prints half a page, then ejects the paper

Check the ink cartridges

Make sure the correct ink cartridges are installed and the ink cartridges are not low on ink. For more information, see [Printer management tools](#) and [Understand the Printer Status Report](#).

HP cannot guarantee the quality of non-HP ink cartridges.

Paper mismatch

Check the settings

Verify that the loaded media size and type matches the control panel settings.

Solve scan problems

 **TIP:** You can visit the HP online support website at www.hp.com/go/customer-care for information and utilities that can help you correct many common printer problems.

- [Scanner did nothing](#)
- [Scan takes too long](#)
- [Part of the document did not scan or text is missing](#)
- [Text cannot be edited](#)
- [Error messages appear](#)
- [Scanned image quality is poor](#)
- [Scan defects are apparent](#)

Scanner did nothing

- **Check the original**
Make sure that the original is loaded correctly. For more information, see [Load an original on the scanner glass](#) or [Load an original in the automatic document feeder \(ADF\)](#).
- **Check the printer**
The printer might be coming out of Sleep mode after a period of inactivity, which delays processing a short while. Wait until the printer displays the Home screen.
- **Check the HP software**
Make sure that the HP software provided with the printer is installed correctly.

Scan takes too long

- **Check the settings**
 - If you set the resolution too high, the scan job takes longer and results in larger files. To obtain good results, do not use a resolution that is higher than needed. You can lower the resolution to scan more quickly.
 - If you acquire an image through TWAIN, you can change the settings so that the original scans in black and white. See the onscreen Help for the TWAIN program for information.
- **Check the status of the printer**

If you sent a print or copy job before you tried to scan, the scan starts if the scanner is not busy. However, the printing and scanning processes share memory, which means that the scan might be slower.

Part of the document did not scan or text is missing

- **Check the original**
 - Make sure that you loaded the original correctly. For more information, see [Load an original on the scanner glass](#) or [Load an original in the automatic document feeder \(ADF\)](#).
 - If you scanned the document from the ADF, try scanning the document directly from the scanner glass. For more information, see [Load an original on the scanner glass](#).
 - Colored backgrounds can cause images in the foreground to blend into the background. Try adjusting the settings before you scan the original, or try enhancing the image after you scan the original.
- **Check the settings**
 - Make sure that the input media size is large enough for the original that you are scanning.
 - If you are using the HP Printer Software, the default settings in the HP Printer Software might be set to automatically perform a specific task other than the one that you are attempting. See the onscreen Help for the HP Printer Software for instructions about changing the properties.

Text cannot be edited

- Make sure that the OCR has been installed:
 - Make sure that the OCR has been installed:

Windows: On the computer desktop, click **Start**, select **Programs** or **All Programs**, click **HP**, select your printer name, and then click **Printer Setup & Software**. Click **Add More Software**, click **Customize Software Selections**, and make sure the OCR option is selected.

Mac OS X: If you have installed the HP software using the Minimum installation option, the OCR software might not have been installed. To install this software, place the HP software CD into the computer, double-click the HP Installer icon on the software CD, and when prompted, select the **HP Recommended Software** option.
 - When you scan the original, make sure that you select a document type in the software that creates editable text. If text is classified as a graphic, it is not converted to text.

- If you are using a separate OCR (optical character recognition) program, the OCR program might be linked to a word-processing program that does not perform OCR tasks. For more information, see the documentation provided with the OCR program.
- Make sure you have selected an OCR language that corresponds to the language used for the document you are scanning. For more information, see the documentation provided with the OCR program.
- **Check the originals**
 - When scanning documents as editable text from the ADF, the original must be loaded into the ADF with the top forward and face up. When scanning from the scanner glass, the original must be loaded with the top facing the right edge of the scanner glass. Also, make sure the document is not skewed. For more information, see [Load an original on the scanner glass](#) or [Load an original in the automatic document feeder \(ADF\)](#).
 - The software might not recognize text that is tightly spaced. For example, if the text that the software converts has missing or combined characters, "rn" might appear as "m."
 - The accuracy of the software depends on the image quality, text size, and structure of the original and the quality of the scan itself. Make sure that your original has good image quality.
 - Colored backgrounds can cause images in the foreground to blend too much.

Error messages appear

- **Unable to activate TWAIN source or An error occurred while acquiring the image**
 - If you are acquiring an image from another device, such as another scanner, make sure that the other device is TWAIN-compliant. Devices that are not TWAIN-compliant do not work with the HP software provided with the printer.
 - If you are using a USB connection, make sure that you have connected the USB Device Cable to the correct port on the back of your computer.
 - Verify that the correct TWAIN source is selected. In the HP software, check the TWAIN source by selecting **Select Scanner** on the **File** menu.
- **Reload document and then restart job**

Touch **OK** on the printer control panel, and then reload the remaining documents in the ADF. For more information see [Load an original in the automatic document feeder \(ADF\)](#).

Scanned image quality is poor

The original is a second-generation photo or picture

Reprinted photographs, such as those in newspapers or magazines, are printed by using tiny dots of ink that make an interpretation of the original photograph, which degrades the quality. Often, the ink dots form unwanted patterns that can be detected when the image is scanned or printed or when the image appears on a screen. If the

following suggestions do not solve the problem, you might need to use a better-quality version of the original.

- To eliminate the patterns, try reducing the size of the image after scanning.
- Print the scanned image to see if the quality is better.
- Make sure that the resolution and color settings are correct for the type of scan job.
- For best results, use the scanner glass for scanning rather than the ADF.

Text or images on the back of a two-sided original appear in the scan

Two-sided originals can "bleed" text or images from the back side to the scan if the originals are printed on media that is too thin or too transparent.

The scanned image is skewed (crooked)

The original might have been loaded incorrectly. Be sure to use the media guides when you load the originals into the ADF. For more information, see [Load an original in the automatic document feeder \(ADF\)](#).

For best results, use the scanner glass for scanning rather than the ADF.

The image quality is better when printed

The image that appears on the screen is not always an accurate representation of the quality of the scan.

- Try adjusting your computer monitor settings to use more colors (or levels of gray). On Windows computers, you typically make this adjustment by opening **Display** on the Windows control panel.
- Try adjusting the resolution and color settings.

The scanned image shows blots, lines, vertical white stripes, or other defects

- If the scanner glass is dirty, the image produced does not have optimum clarity. See [Maintain the printer](#) for cleaning instructions.
- The defects might be on the original and are not a result of the scanning process.

Graphics look different from the original

Scan at a higher resolution.

 **NOTE:** Scanning at high resolution can take a long time, and it can take up a large amount of space on your computer.

Take steps to improve the scan quality

- Use the glass to scan rather than the ADF.
- Use high-quality originals.
- Place the media correctly. If the media is placed incorrectly on the scanner glass, it might skew, which causes unclear images. For more information, see [Load an original on the scanner glass](#).
- Adjust the HP software settings according to how you plan to use the scanned page.
- Use or make a carrier sheet to protect your originals.
- Clean the scanner glass. For more information, see [Clean the scanner glass](#).

Scan defects are apparent

- **Blank pages**

Make sure that the original document is placed correctly. Place the original document face down on the flatbed scanner with the top-left corner of the document located in the lower-right corner of the scanner glass.
- **Too light or dark**
 - Try adjusting the settings. Be sure to use the correct resolution and color settings.
 - The original image might be very light or dark or might be printed on colored paper.
- **Unwanted lines**

Ink, glue, correction fluid, or an unwanted substance might be on the scanner glass. Try cleaning the scanner glass. For more information, see [Maintain the printer](#).
- **Black dots or streaks**
 - Ink, glue, correction fluid, or an unwanted substance might be on the scanner glass; the scanner glass might be dirty or scratched; or the lid backing might be dirty. Try cleaning the scanner glass and lid backing. For more information, see [Maintain the printer](#). If cleaning does not correct the problem, the scanner glass or lid backing might need to be replaced.
 - The defects might be on the original and are not a result of the scanning process.
- **Unclear text**

Try adjusting the settings. Make sure that the resolution and color settings are correct.
- **Size is reduced**

The HP software settings might be set to reduce the scanned image. See the HP printer software Help for more information about changing the settings.

Solve fax problems

This section contains fax setup troubleshooting information for the printer. If the printer is not set up correctly for faxing, you might experience problems when sending faxes, receiving faxes, or both.

If you are having faxing problems, you can print a fax test report to check the status of the printer. The test fails if the printer is not set up correctly for faxing. Perform this test after you have completed setting up the printer for faxing. For more information, see [Test fax setup](#).

If the test fails, review the report for information on how to fix any problems found. For more information, see [The fax test failed](#).

 **TIP:** You can visit the HP online support website at www.hp.com/go/customer-care for information and utilities that can help you correct many common printer problems.

- [The fax test failed](#)
- [The display always shows Phone Off Hook](#)

- [The printer is having problems sending and receiving faxes](#)
- [The printer is having problems sending a manual fax](#)
- [The printer cannot receive faxes, but can send faxes](#)
- [The printer cannot send faxes, but can receive faxes](#)
- [Fax tones are recorded on my answering machine](#)
- [The phone cord that came with my printer is not long enough](#)
- [Color faxes do not print](#)
- [The computer cannot receive faxes \(Fax to PC and Fax to Mac\)](#)

The fax test failed

If you ran a fax test and the test failed, review the report for basic information about the error. For more detailed information, check the report to see which part of the test failed, and then review the appropriate topic in this section for solutions to try.

This section contains the following topics:

- [The "Fax Hardware Test" failed](#)
- [The "Fax Connected to Active Telephone Wall Jack" test failed](#)
- [The "Phone Cord Connected to Correct Port on Fax" test failed](#)
- [The "Using Correct Type of Phone Cord with Fax" test failed](#)
- [The "Dial Tone Detection" test failed](#)
- [The "Fax Line Condition" test failed](#)

The "Fax Hardware Test" failed

Solution:

- Turn the printer off by pressing the  (Power) button located on the printer control panel and then unplug the power cord from the back of the printer. After a few seconds, plug the power cord in again, and then turn the power on. Run the test again. If the test fails again, continue reviewing the troubleshooting information in this section.
- Try to send or receive a test fax. If you can send or receive a fax successfully, there might not be a problem.
- If you are running the test from the **Fax Setup Wizard** (Windows) or **HP Setup Assistant** (Mac OS X), make sure the printer is not busy completing another task, such as receiving a fax or making a copy. Check the display for a message indicating that the printer is busy. If it is busy, wait until it is finished and in the idle state before running the test.
- Make sure you use the phone cord that came with the printer. If you do not use the supplied phone cord to connect from the telephone wall jack to the printer, you might not be able to send or receive faxes. After you plug in the phone cord that came with the printer, run the fax test again.
- If you are using a phone splitter, this can cause faxing problems. (A splitter is a two-cord connector that plugs into a telephone wall jack.) Try removing the splitter and connecting the printer directly to the telephone wall jack.

After you resolve any problems found, run the fax test again to make sure it passes and the printer is ready for faxing. If the **Fax Hardware Test** continues to fail and you experience problems faxing, contact HP support. Go to www.hp.com/

go/customercare. This website provides information and utilities that can help you correct many common printer problems. If prompted, select your country/region, and then click **Contact HP** for information on calling for technical support.

The "Fax Connected to Active Telephone Wall Jack" test failed

Solution:

- Check the connection between the telephone wall jack and the printer to make sure the phone cord is secure.
- Make sure you use the phone cord that came with the printer. If you do not use the supplied phone cord to connect from the telephone wall jack to the printer, you might not be able to send or receive faxes. After you plug in the phone cord that came with the printer, run the fax test again.
- Make sure you have correctly connected the printer to the telephone wall jack. Using the phone cord supplied in the box with the printer, connect one end to your telephone wall jack, then connect the other end to the port labeled 1-LINE on the back of the printer. For more information on setting up the printer for faxing, see [Additional fax setup](#).
- If you are using a phone splitter, this can cause faxing problems. (A splitter is a two-cord connector that plugs into a telephone wall jack.) Try removing the splitter and connecting the printer directly to the telephone wall jack.
- Try connecting a working phone and phone cord to the telephone wall jack that you are using for the printer and check for a dial tone. If you do not hear a dial tone, contact your telephone company and have them check the line.
- Try to send or receive a test fax. If you can send or receive a fax successfully, there might not be a problem.

After you resolve any problems found, run the fax test again to make sure it passes and the printer is ready for faxing.

The "Phone Cord Connected to Correct Port on Fax" test failed

Solution: Plug the phone cord into the correct port.

1. Using the phone cord supplied in the box with the printer, connect one end to your telephone wall jack, then connect the other end to the port labeled 1-LINE on the back of the printer.

 **NOTE:** If you use the 2-EXT port to connect to the telephone wall jack, you cannot send or receive faxes. The 2-EXT port should only be used to connect other equipment, such as an answering machine.

Figure 8-1 Back view of the printer

1	Telephone wall jack
2	Use the phone cord supplied in the box with the printer to connect to the "1-LINE" port

2. After you have connected the phone cord to the port labeled 1-LINE, run the fax test again to make sure it passes and the printer is ready for faxing.
3. Try to send or receive a test fax.
 - Make sure you use the phone cord that came with the printer. If you do not use the supplied phone cord to connect from the telephone wall jack to the printer, you might not be able to send or receive faxes. After you plug in the phone cord that came with the printer, run the fax test again.
 - If you are using a phone splitter, this can cause faxing problems. (A splitter is a two-cord connector that plugs into a telephone wall jack.) Try removing the splitter and connecting the printer directly to the telephone wall jack.

The "Using Correct Type of Phone Cord with Fax" test failed

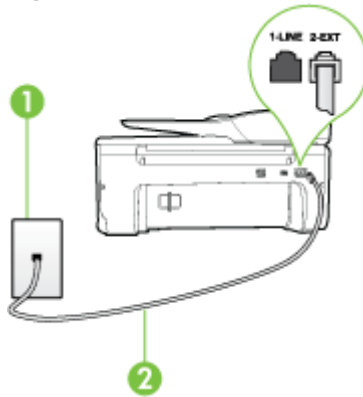
Solution:

- Make sure you used the phone cord in the box with the printer to connect to the telephone wall jack. One end of the phone cord should be

connected to the port labeled 1-LINE on the back of the printer, and the other end to your telephone wall jack, as shown in the illustration.

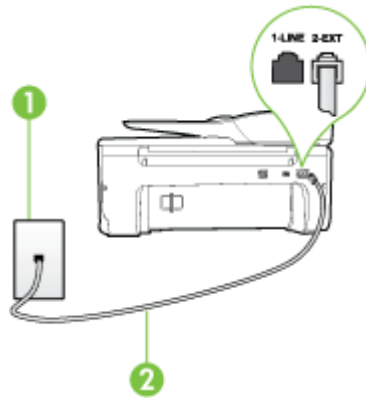

1	Telephone wall jack
2	Use the phone cord supplied in the box with the printer to connect to the "1-LINE" port

If the phone cord that came with the printer is not long enough, you can use a coupler to extend the length. You can purchase a coupler at an electronics store that carries phone accessories. You also need another phone cord, which can be a standard phone cord that you might already have in your home or office.

- Check the connection between the telephone wall jack and the printer to make sure the phone cord is secure.
- Make sure you use the phone cord that came with the printer. If you do not use the supplied phone cord to connect from the telephone wall jack to the printer, you might not be able to send or receive faxes. After you plug in the phone cord that came with the printer, run the fax test again.
- If you are using a phone splitter, this can cause faxing problems. (A splitter is a two-cord connector that plugs into a telephone wall jack.) Try removing the splitter and connecting the printer directly to the telephone wall jack.

The "Dial Tone Detection" test failed

Solution:

- Other equipment, which uses the same phone line as the printer, might be causing the test to fail. To find out if other equipment is causing a problem, disconnect everything from the phone line, and then run the test again. If the **Dial Tone Detection Test** passes without the other equipment, then one or more pieces of the equipment is causing problems; try adding them back one at a time and rerunning the test each time, until you identify which piece of equipment is causing the problem.
- Try connecting a working phone and phone cord to the telephone wall jack that you are using for the printer and check for a dial tone. If you do not hear a dial tone, contact your telephone company and have them check the line.
- Make sure you have correctly connected the printer to the telephone wall jack. Using the phone cord supplied in the box with the printer, connect one end to your telephone wall jack, then connect the other end to the port labeled 1-LINE on the back of the printer.
- If you are using a phone splitter, this can cause faxing problems. (A splitter is a two-cord connector that plugs into a telephone wall jack.) Try removing the splitter and connecting the printer directly to the telephone wall jack.
- If your telephone system is not using a standard dial tone, such as some PBX systems, this might cause the test to fail. This does not cause a problem sending or receiving faxes. Try sending or receiving a test fax.
- Check to make sure the country/region setting is set appropriately for your country/region. If the country/region setting is not set or is set incorrectly, the test might fail and you might have problems sending and receiving faxes.
- Make sure you connect the printer to an analog phone line or you cannot send or receive faxes. To check if your phone line is digital, connect a regular analog phone to the line and listen for a dial tone. If you do not hear a normal sounding dial tone, it might be a phone line set up for digital phones. Connect the printer to an analog phone line and try sending or receiving a fax.
- Make sure you use the phone cord that came with the printer. If you do not use the supplied phone cord to connect from the telephone wall jack to the printer, you might not be able to send or receive faxes. After you plug in the phone cord that came with the printer, run the fax test again.

After you resolve any problems found, run the fax test again to make sure it passes and the printer is ready for faxing. If the **Dial Tone Detection** test continues to fail, contact your telephone company and have them check the phone line.

The "Fax Line Condition" test failed

Solution:

- Make sure you connect the printer to an analog phone line or you cannot send or receive faxes. To check if your phone line is digital, connect a regular analog phone to the line and listen for a dial tone. If you do not hear a normal sounding dial tone, it might be a phone line set up for digital phones. Connect the printer to an analog phone line and try sending or receiving a fax.
- Check the connection between the telephone wall jack and the printer to make sure the phone cord is secure.
- Make sure you have correctly connected the printer to the telephone wall jack. Using the phone cord supplied in the box with the printer, connect one end to your telephone wall jack, then connect the other end to the port labeled 1-LINE on the back of the printer.
- Other equipment, which uses the same phone line as the printer, might be causing the test to fail. To find out if other equipment is causing a problem, disconnect everything from the phone line, and then run the test again.
 - If the **Fax Line Condition Test** passes without the other equipment, then one or more pieces of the equipment is causing problems; try adding them back one at a time and rerunning the test each time, until you identify which piece of equipment is causing the problem.
 - If the **Fax Line Condition Test** fails without the other equipment, connect the printer to a working phone line and continue reviewing the troubleshooting information in this section.
- If you are using a phone splitter, this can cause faxing problems. (A splitter is a two-cord connector that plugs into a telephone wall jack.) Try removing the splitter and connecting the printer directly to the telephone wall jack.
- Make sure you use the phone cord that came with the printer. If you do not use the supplied phone cord to connect from the telephone wall jack to the printer, you might not be able to send or receive faxes. After you plug in the phone cord that came with the printer, run the fax test again.



After you resolve any problems found, run the fax test again to make sure it passes and the printer is ready for faxing. If the **Fax Line Condition test** continues to fail and you experience problems faxing, contact your telephone company and have them check the phone line.

The display always shows Phone Off Hook

Solution: You are using the wrong type of phone cord. Make sure you are using the phone cord that came with the printer to connect the printer to your phone line. If the phone cord that came with the printer is not long enough, you can use a coupler to extend the length. You can purchase a coupler at an electronics store that carries phone accessories. You also need another phone cord, which can be a standard phone cord that you might already have in your home or office.

Solution: Other equipment that uses the same phone line as the printer might be in use. Make sure extension phones (phones on the same phone line, but not connected to the printer) or other equipment are not in use or off the hook. For example, you cannot use the printer for faxing if an extension phone is off the hook, or if you are using a computer dial-up modem to send email or access the Internet.

The printer is having problems sending and receiving faxes

Solution: Make sure the printer is turned on. Look at the display on the printer. If the display is blank and the  (Power button) light is not lit, the printer is turned off. Make sure the power cord is firmly connected to the printer and plugged into a power outlet. Press the  (Power) button to turn on the printer.

After turning on the printer, HP recommends you wait five minutes before sending or receiving a fax. The printer cannot send or receive faxes while it is initializing after being turned on.

Solution: If Fax to PC or Fax to Mac has been enabled, you might not be able to send or receive faxes if the fax memory is full (limited by printer memory).

Solution:

- Make sure you used the phone cord supplied in the box with the printer to connect to the telephone wall jack. One end of the phone cord should be connected to the port labeled 1-LINE on the back of the printer and the other end to your telephone wall jack, as shown in the illustration.

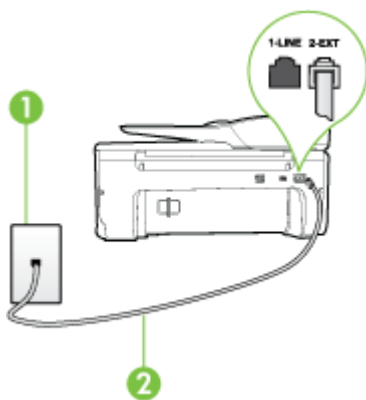

1	Telephone wall jack
2	Use the phone cord supplied in the box with the printer to connect to the "1-LINE" port

If the phone cord that came with the printer is not long enough, you can use a coupler to extend the length. You can purchase a coupler at an

electronics store that carries phone accessories. You also need another phone cord, which can be a standard phone cord that you might already have in your home or office.

- Try connecting a working phone and phone cord to the telephone wall jack that you are using for the printer and check for a dial tone. If you do not hear a dial tone, call your local telephone company for service.
- Other equipment, which uses the same phone line as the printer, might be in use. For example, you cannot use the printer for faxing if an extension phone is off the hook, or if you are using a computer dial-up modem to send an email or access the Internet.
- Check to see if another process has caused an error. Check the display or your computer for an error message providing information about the problem and how to solve it. If there is an error, the printer cannot send or receive a fax until the error condition is resolved.
- The phone line connection might be noisy. Phone lines with poor sound quality (noise) can cause faxing problems. Check the sound quality of the phone line by plugging a phone into the telephone wall jack and listening for static or other noise. If you hear noise, turn **Error Correction Mode (ECM)** off and try faxing again. For information about changing ECM, see [Send a fax in Error Correction Mode](#). If the problem persists, contact your telephone company.
- If you are using a digital subscriber line (DSL) service, make sure that you have a DSL filter connected or you cannot fax successfully. For more information, see [Case B: Set up the printer with DSL](#).
- Make sure the printer is not connected to a telephone wall jack that is set up for digital phones. To check if your phone line is digital, connect a regular analog phone to the line and listen for a dial tone. If you do not hear a normal sounding dial tone, it might be a phone line set up for digital phones.
- If you are using either a private branch exchange (PBX) or an integrated services digital network (ISDN) converter/terminal adapter, make sure the printer is connected to the correct port and the terminal adapter is set to the correct switch type for your country/region, if possible. For more information, see [Case C: Set up the printer with a PBX phone system or an ISDN line](#).

- If the printer shares the same phone line with a DSL service, the DSL modem might not be grounded correctly. If the DSL modem is not grounded correctly, it can create noise on the phone line. Phone lines with poor sound quality (noise) can cause faxing problems. You can check the sound quality of the phone line by plugging a phone into the telephone wall jack and listening for static or other noise. If you hear noise, turn off your DSL modem and completely remove power for at least 15 minutes. Turn the DSL modem back on and listen to the dial tone again.

 **NOTE:** You might notice static on the phone line again in the future. If the printer stops sending and receiving faxes, repeat this process.

If the phone line is still noisy, contact your telephone company. For information on turning your DSL modem off, contact your DSL provider for support.

- If you are using a phone splitter, this can cause faxing problems. (A splitter is a two-cord connector that plugs into a telephone wall jack.) Try removing the splitter and connecting the printer directly to the telephone wall jack.

The printer is having problems sending a manual fax

Solution:

 **NOTE:** This possible solution applies only in the countries/regions that receive a 2-wire phone cord in the box with the printer, including: Argentina, Australia, Brazil, Canada, Chile, China, Colombia, Greece, India, Indonesia, Ireland, Japan, Korea, Latin America, Malaysia, Mexico, Philippines, Poland, Portugal, Russia, Saudi Arabia, Singapore, Spain, Taiwan, Thailand, USA, Venezuela, and Vietnam.

- Make sure the telephone you use to initiate the fax call is connected directly to the printer. To send a fax manually, the telephone must be connected directly to the port labeled 2-EXT on the printer, as shown in the illustration.

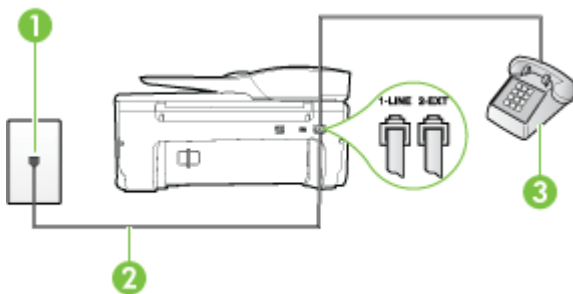

1	Telephone wall jack
2	Use the phone cord supplied in the box with the printer to connect to the "1-LINE" port
3	Telephone

- If you are sending a fax manually from your phone that is connected directly to the printer, you must use the keypad on the telephone to send the fax. You cannot use the keypad on the printer control panel.



NOTE: If using a serial-type phone system, connect your phone directly on top of the printer cable which has a wall plug attached to it.

The printer cannot receive faxes, but can send faxes

Solution:

- If you are not using a distinctive ring service, check to make sure that the **Distinctive Ring** feature on the printer is set to **All Rings**. For more information, see [Change the answer ring pattern for distinctive ring](#).
- If **Auto Answer** is set to **Off**, you need to receive faxes manually; otherwise, the printer cannot receive the fax. For information on receiving faxes manually, see [Receive a fax manually](#).
- If you have a voice mail service at the same phone number you use for fax calls, you must receive faxes manually, not automatically. This means that you must be available to respond in person to incoming fax calls. For information on setting up the printer when you have a voice mail service, see [Case F: Shared voice/fax line with voice mail](#). For information on receiving faxes manually, see [Receive a fax manually](#).
- If you have a computer dial-up modem on the same phone line with the printer, check to make sure that the software that came with your modem is not set to receive faxes automatically. Modems that are set up to receive faxes automatically take over the phone line to receive all incoming faxes, which prevents the printer from receiving fax calls.
- If you have an answering machine on the same phone line with the printer, you might have one of the following problems:
 - Your answering machine might not be set up correctly with the printer.
 - Your outgoing message might be too long or too loud to allow the printer to detect fax tones, and the sending fax machine might disconnect.
 - Your answering machine might not have enough quiet time after your outgoing message to allow the printer to detect fax tones. This problem is most common with digital answering machines.

The following actions might help solve these problems:

- When you have an answering machine on the same phone line you use for fax calls, try connecting the answering machine directly to the printer as described in [Case I: Shared voice/fax line with answering machine](#).
- Make sure the printer is set to receive faxes automatically. For information on setting up the printer to receive faxes automatically, see [Receive a fax](#).
- Make sure the **Rings to Answer** setting is set to a greater number of rings than the answering machine. For more information, see [Set the number of rings before answering](#).

- Disconnect the answering machine and then try receiving a fax. If faxing is successful without the answering machine, the answering machine might be causing the problem.
- Reconnect the answering machine and record your outgoing message again. Record a message that is approximately 10 seconds in duration. Speak slowly and at a low volume when recording your message. Leave at least 5 seconds of silence at the end of the voice message. There should be no background noise when recording this silent time. Try to receive a fax again.



NOTE: Some digital answering machines might not retain the recorded silence at the end of your outgoing message. Play back your outgoing message to check.

- If the printer shares the same phone line with other types of phone equipment, such as an answering machine, a computer dial-up modem, or a multi-port switch box, the fax signal level might be reduced. The signal level can also be reduced if you use a splitter or connect extra cables to extend the length of your phone. A reduced fax signal can cause problems during fax reception.
To find out if other equipment is causing a problem, disconnect everything except the printer from the phone line, and then try to receive a fax. If you can receive faxes successfully without the other equipment, one or more pieces of the other equipment is causing problems; try adding them back one at a time and receiving a fax each time, until you identify which equipment is causing the problem.
 - If you have a special ring pattern for your fax phone number (using a distinctive ring service through your telephone company), make sure that the **Distinctive Ring** feature on the printer is set to match. For more information, see [Change the answer ring pattern for distinctive ring](#).
-

The printer cannot send faxes, but can receive faxes

Solution:

- The printer might be dialing too fast or too soon. You might need to insert some pauses in the number sequence. For example, if you need to access an outside line before dialing the phone number, insert a pause following the access number. If your number is 95555555, and 9 accesses an outside line, you might insert pauses as follows: 9-555-5555. To enter a pause in the fax number you are typing, touch the * button repeatedly, until a dash (-) appears on the display.
You can also send the fax using monitor dialing. This enables you to listen to the phone line as you dial. You can set the pace of your dialing and respond to prompts as you dial. For more information, see [Send a fax using monitor dialing](#).
 - The number you entered when sending the fax is not in the proper format or the receiving fax machine is having problems. To check this, try calling the fax number from a telephone and listen for fax tones. If you cannot hear fax tones, the receiving fax machine might not be turned on or connected, or a voice mail service could be interfering with the recipient's phone line. You can also ask the recipient to check the receiving fax machine for any problems.
-

Fax tones are recorded on my answering machine

Solution:

- When you have an answering machine on the same phone line you use for fax calls, try connecting the answering machine directly to the printer as described in [Case I: Shared voice/fax line with answering machine](#). If you do not connect the answering machine as recommended, fax tones might be recorded on your answering machine.
 - Make sure the printer is set to receive faxes automatically and that the **Rings to Answer** setting is correct. The number of rings to answer for the printer should be greater than the number of rings to answer for the answering machine. If the answering machine and the printer are set to the same number of rings to answer, both devices answer the call and fax tones are recorded on the answering machine.
 - Set your answering machine to a low number of rings and the printer to answer in the maximum number of rings supported. (The maximum number of rings varies by country/region.) In this setup, the answering machine answers the call and the printer monitors the line. If the printer detects fax tones, the printer receives the fax. If the call is a voice call, the answering machine records the incoming message. For more information, see [Set the number of rings before answering](#).
-

The phone cord that came with my printer is not long enough

Solution: If the phone cord that came with the printer is not long enough, you can use a coupler to extend the length. You can purchase a coupler at an

electronics store that carries phone accessories. You also need another phone cord, which can be a standard phone cord that you might already have in your home or office.

 **TIP:** If the printer came with a 2-wire phone cord adaptor, you can use it with a 4-wire phone cord to extend the length. For information on using the 2-wire phone cord adaptor, see the documentation that came with it.

To extend your phone cord

1. Using the phone cord supplied in the box with the printer, connect one end to the coupler, then connect the other end to the port labeled 1-LINE on the back of the printer.
2. Connect another phone cord to the open port on the coupler and to the telephone wall jack.

Color faxes do not print

Cause: The Incoming Fax Printing option is turned off.

Solution: To print color faxes, make sure that the Incoming Fax Printing option in the printer control panel is turned on.

The computer cannot receive faxes (Fax to PC and Fax to Mac)

Cause: The computer selected to receive faxes is turned off.

Solution: Make sure the computer selected to receive faxes is switched on at all times.

Cause: Different computers are configured for setup and receiving faxes and one of them may be switched off.

Solution: If the computer receiving faxes is different from the one used for setup, both computers should be switched on at all times.

Cause: Fax to PC or Fax to Mac is not activated or the computer is not configured to receive faxes.

Solution: Activate Fax to PC or Fax to Mac and make sure the computer is configured to receive faxes.

Solve problems using Web Services and HP websites

This section provides solutions to common problems using Web Services and HP websites.

- [Solve problems using Web Services](#)
- [Solve problems using HP websites](#)

Solve problems using Web Services

If you are having problems using Web Services, such as HP ePrint and Printer Apps, check the following:

Make sure the printer is connected to the Internet using a wireless connection. (Web Services is not available for Internet connections using 3G or 4G networks.)

 **NOTE:** You cannot use these web features if the printer is connected using a USB cable.

- Make sure the latest product updates have been installed on the printer. For more information, see [Update the printer](#).
- Make sure Web Services is enabled on the printer. For more information, see [Set up Web Services using the printer's control panel](#).
- Make sure the network hub, switch, or router is turned on and working correctly.
- If you are connecting the printer using a wireless connection, make sure the wireless network is functioning properly. For more information, see [Solve wireless problems](#).
- If you are using HP ePrint, check the following:
 - Make sure the printer's email address is correct.
 - Make sure that the printer's email address is the only address listed in the "To" line of the email message. If other email addresses are listed in the "To" line, the attachments you are sending might not print.
 - Make sure you are sending documents that meet the HP ePrint requirements. For more information, see [Web Services specifications](#).
- If your network uses proxy settings when connecting to the Internet, make sure the proxy settings you are entering are valid:
 - Check the settings being used by the Web browser you are using (such as Internet Explorer, Firefox, or Safari).
 - Check with the IT administrator or person who set up your firewall. If the proxy settings used by your firewall have changed, you must update these settings in either the printer's control panel. If these settings are not updated, you will not be able to use Web Services. For more information, see [Set up Web Services using the printer's control panel](#).

 **TIP:** For additional help on setting up and using Web Services, visit ePrintCenter at www.eprintcenter.com.

Solve problems using HP websites

If you are having problems using HP websites from your computer, check the following:

- Make sure the computer that you are using is connected to the Internet.
- Make sure the web browser meets the minimum system requirements. For more information, see [HP website specifications](#).
- If your web browser uses any proxy settings to connect to the Internet, try turning off these settings. For more information, see the documentation provided with your web browser.

Solve wireless problems

This section provides information about solving problems you might encounter when connecting the printer to your wireless network.

Follow these suggestions in order, starting with those listed in the “Basic wireless troubleshooting” section. If you still encounter problems, follow the suggestions provided in the “Advanced wireless troubleshooting” section.

- [Basic wireless troubleshooting](#)
- [Advanced wireless troubleshooting](#)

 **TIP:** For more information about troubleshooting wireless problems, go to www.hp.com/go/wirelessprinting.

TIP: If you are using a computer running Windows, HP provides a tool called HP Home Network Diagnostic Utility that can help retrieve this information for some systems. To use this tool, visit the HP Wireless Printing Center (www.hp.com/go/wirelessprinting), and then click Network Diagnostic Utility in the Quick Links section. (At this time, this tool might not be available in all languages.)

 **NOTE:** After you resolve the problem, follow the instructions in [After resolving the problems](#).

Basic wireless troubleshooting

Perform the following steps in the order presented.

Step 1 - Make sure the wireless (802.11) light is turned on

If the blue light is not on, the wireless capabilities might not have been turned on.

If you see a **Wireless: Off** option in the list, touch this option, and then touch **On**.

Step 2 - Restart components of the wireless network

Turn off the router and the printer, and then turn them back on in this order: router first and then the printer. If you still are unable to connect, turn off the router, printer, and your computer. Sometimes, turning off the power and then turning it back on recovers from a network communication issue.

Step 3 - Run the Wireless Network Test

For wireless networking issues, run the Wireless Network Test.

To print a Wireless Test Report, touch  (right arrow), touch **Setup**, touch **Network**, and then select **Print Wireless Network Test**. If a problem is detected, the printed test report includes recommendations that might help solve the problem.

 **TIP:** If the Wireless Network Test indicates the signal is weak, try moving the printer closer to the wireless router.

Advanced wireless troubleshooting

If you have tried the steps provided in [Basic wireless troubleshooting](#) and are still unable to connect to your printer to the wireless network, try the following steps in the order presented:

- [Step 1: Make sure your computer is connected to your network](#)
- [Step 2: Make sure that the printer is connected to your network](#)
- [Step 3: Check to see if the firewall software is blocking communication](#)
- [Step 4: Make sure the printer is online and ready](#)
- [Step 5: Make sure the wireless version of the printer is set as the default printer driver \(Windows only\)](#)
- [Step 6: Make sure your computer is not connected to your network over a Virtual Private Network \(VPN\)](#)
- [After resolving the problems](#)

Step 1: Make sure your computer is connected to your network

Make sure your computer is connected to your wireless network. If the computer is not connected to the network, you cannot use the printer over the network.

To check a wireless connection

1. Make sure that your computer's wireless has been turned on. For more information, see the documentation that came with your computer.
2. If you are not using a unique network name (SSID), then it is possible that your wireless computer could be connected to a nearby network that is not yours. The following steps can help you determine if your computer is connected to your network.

Windows

- a. Click **Start**, click **Control Panel**, point to **Network Connections**, and then click **View Network Status and Tasks**.
or
Click **Start**, select **Settings**, click **Control Panel**, double-click **Network Connections**, click the **View** menu, and then select **Details**.
Leave the network dialog box open while you continue to the next step.
- b. Disconnect the power cord from the wireless router. The connection status of your computer should change to **Not Connected**.
- c. Reconnect the power cord to the wireless router. The connection status should change to **Connected**.

Mac OS X

- ▲ Click the **AirPort** icon in the menu bar at the top of the screen. From the menu that appears, you can determine if the AirPort is turned on and which wireless network your computer is connected to.

 **NOTE:** For more detailed information about your AirPort connection, click **System Preferences** in the Dock, and then click **Network**. If the wireless connection is working correctly, a green dot appears next to AirPort in the list of connections. For more information, click the Help button in the window.

If you are unable to get your computer connected to your network, contact the person who set up your network or the router manufacturer as there might be a hardware issue with either your router or computer.

 **TIP:** If you are able to access the Internet and are using a computer running Windows, you can also access HP Network Assistant at www.hp.com/sbso/wireless/tools-setup.html?jumpid=reg_R1002_USEN for help in setting up a network (This web site is only available in English).

Step 2: Make sure that the printer is connected to your network

If your printer is not connected to the same network as your computer, you cannot use the printer over the network. Follow the steps described in this section to find out if your printer is actively connected to the correct network.

 **NOTE:** If your wireless router or Apple AirPort Base Station is using a hidden SSID, your printer cannot automatically detect the network.

A: Make sure the printer is on the network

1. If the printer is connected to a wireless network, print the network configuration page. For more information, see [Understand the network configuration page](#).
2. After the page has been printed, check the Network Status and URL:

Network Status	<ul style="list-style-type: none"> • If the Network Status is Ready, the printer is actively connected to a network. • If the Network Status is Offline, the printer is not connected to a network. Run the Wireless Network Test using the instructions at the beginning of this section, and then follow any recommendations.
URL	The URL shown here is the network address assigned to the printer by your router. You need this to connect to the embedded web server (EWS).

For information about connecting the printer to a wireless network, see [Set up the printer for wireless communication](#).

B: Check to see if you can access the EWS

After you establish that the computer and the printer both have active connections to a network, you can verify if they are on the same network by accessing the printer's EWS. For more information, see [Embedded web server](#).

To access the EWS

1. On your computer, open the EWS. For more information, see [Embedded web server](#).



NOTE: If you are using a proxy server in your browser, you might need to disable it to access the EWS.

2. If you can access the EWS, try using the printer over the network (such as to print) to see if your network setup was successful.
3. If you cannot access the EWS or are still having problems using the printer over the network, continue to the next section regarding firewalls.

Step 3: Check to see if the firewall software is blocking communication

If you cannot access the EWS and are sure both the computer and printer have active connections to the same network, the firewall security software might be blocking communication. Temporarily turn off any firewall security software running on your computer and then try to access the EWS again. If you can access the EWS, try using the printer (for printing).

If you are able to open the EWS and use your printer with the firewall turned off, you need to reconfigure your firewall settings to allow the computer and printer to communicate with each other over the network. For more information, see [Configure your firewall software to work with the printer](#).

If you are able to access the EWS, but are still unable to use the printer even with the firewall turned off, try enabling the firewall software to recognize the printer. For more information, see the documentation provided with your firewall software.

Step 4: Make sure the printer is online and ready

If you have the HP software installed, you can check the printer's status from your computer to see if the printer is paused or offline, preventing you from using it.

To check the printer's status, follow the instructions for your operating system:

Windows

1. Click **Start**, and then click **Printers** or **Printers and Faxes** or **Devices and Printers**.
- Or -
Click **Start**, click **Control Panel**, and then double-click **Printers**.
2. If the printers on your computer are not being displayed in Details view, click the **View** menu, and then click **Details**.
3. Do one of the following, depending on the printer status:
 - a. If the printer is **Offline**, right-click the printer, and click **Use Printer Online**.
 - b. If the printer is **Paused**, right-click the printer, and click **Resume Printing**.
4. Try using the printer over the network.

Mac OS X

1. Click **System Preferences** in the Dock, and then click **Print & Fax** or **Print & Scan**.
2. Select the printer, and then click **Open Print Queue**.
3. If the print job is on hold, click **Resume**.
4. If the printer is paused, click **Resume Printer**.

If you can use the printer after performing the steps above but find that the symptoms persist as you continue to use the printer, your firewall might be interfering. For more information, see [Configure your firewall software to work with the printer](#)

If you still cannot use the printer over the network, continue to the next section for additional troubleshooting help

Step 5: Make sure the wireless version of the printer is set as the default printer driver (Windows only)

If you install the HP software again, the installer might create a second version of the printer driver in your **Printers** or **Printers and Faxes** or **Devices and Printers** folder. If you have difficulties printing or connecting to the printer, make sure the correct version of the printer driver is set as the default.

1. Click **Start**, and then click **Printers** or **Printers and Faxes** or **Devices and Printers**.
- Or -
Click **Start**, click **Control Panel**, and then double-click **Printers**.
2. Determine if the version of the printer driver in the **Printers** or **Printers and Faxes** or **Devices and Printers** folder is connected wirelessly:
 - a. Right-click the printer icon, and then click **Properties**, **Document Defaults**, or **Printing Preferences**.
 - b. On the **Ports** tab, look for a port in the list with a checkmark. The version of the printer driver that is connected wirelessly has **HP network re-discovery port monitor** as the Port description, next to the checkmark.
3. Right-click the printer icon for the version of the printer driver that is connected wirelessly, and select **Set as Default Printer**.



NOTE: If there is more than one icon in the folder for the printer, right-click the printer icon for the version of the printer driver that is connected wirelessly, and select **Set as Default Printer**.

Step 6: Make sure your computer is not connected to your network over a Virtual Private Network (VPN)

A Virtual Private Network (VPN) is a computer network that uses the Internet to provide a remote, secure connection to an organization's network. However, most VPN services do not allow you to access local devices (like your printer) on your local network while your computer is connected to the VPN.

To connect to the printer, disconnect from the VPN.

 **TIP:** To use the printer while connected to the VPN, you can connect the printer to your computer with a USB cable. The printer uses its USB and network connections at the same time.

For more information, contact your network administrator or the person who set up the wireless network.

After resolving the problems

After you resolve any problems and have successfully connected the printer to your wireless network, complete the following steps for your operating system:

Windows

1. On the computer desktop, click **Start**, select **Programs** or **All Programs**, click **HP**, select your printer name, and then click **Printer Setup & Software**.
2. Click **Connect a new printer**, and then select the type of connection you want to use.

Mac OS X

1. Open HP Utility. For more information, see [HP Utility \(Mac OS X\)](#).
2. Click the **Applications** icon on the toolbar, double-click **HP Setup Assistant**, and then follow the onscreen instructions.

Configure your firewall software to work with the printer

A personal firewall, which is security software running on your computer, can block network communication between your printer and your computer.

If you are having problems such as:

- Printer not found when installing HP software
- Unable to print, print job stuck in queue or printer goes offline
- Scan communication errors or scanner busy messages
- Unable to see printer status on your computer

The firewall might be preventing your printer from notifying computers on your network where it can be found.

If you are using the HP software on a computer running Windows and cannot find the printer during installation (and you know the printer is on the network)—or if you have already successfully installed HP software and experience problems—check the following:

- If you have just installed the HP software, try turning off your computer and the printer, and then turning them both on again.
- Keep your security software up to date. Many security software vendors provide updates that correct known issues and provide the latest defenses against new security threats.
- If your firewall has "High," "Medium," or "Low" security settings, use the "Medium" setting when your computer is connected to your network.
- If you have changed any firewall settings from default, try going back to the default setting.

- If your firewall has a setting called "trusted zone," use this setting when your computer is connected to your network.
- If your firewall has a setting to "not show alert messages," you should disable this. When installing the HP software and using the HP printer you may see alert messages from your firewall software that provide options to "allow," "permit" or "unblock." You should allow any HP software that causes an alert. Also, if the alert has a "remember this action" or "create a rule for this" selection, select it. This is how the firewall learns what can be trusted on your network.
- Do not have more than one firewall enabled at the same time on your computer. An example would be having both the Windows firewall provided by the operating system and a third party firewall enabled at the same time. Having more than one firewall enabled at the same time will not make you computer any safer and may cause problems.

For more information about using your printer with personal firewall software, visit www.hp.com/go/wirelessprinting, and then click **Firewall Help** in the **Need Help Troubleshooting?** section.

 **NOTE:** At this time, some portions of this site are not available in all languages.

Solve printer management problems

This section provides solutions to common problems that involve managing the printer. This section contains the following topic:

- [Embedded web server cannot be opened](#)

 **NOTE:** To use the embedded web server, the printer must be connected to a network using a wireless connection. You cannot use the embedded web server if the printer is connected to a computer with a USB cable.

 **TIP:** You can visit the HP online support website at www.hp.com/go/customer-care for information and utilities that can help you correct many common printer problems.

Embedded web server cannot be opened

Check your network setup

- Make sure you are not using a phone cord or a crossover cable to connect the printer to the network.
- Make sure the network cable is securely connected to the printer.
- Make sure the network hub, switch, or router is turned on and working correctly.

Check the computer

Make sure the computer that you are using is connected to the network.

 **NOTE:** To use the EWS, the printer must be connected to a network. You cannot use the embedded web server if the printer is connected to a computer with a USB cable.

Check your web browser

- Make sure the web browser meets the minimum system requirements. For more information, see [Embedded web server specifications](#).
- If your web browser uses any proxy settings to connect to the Internet, try turning off these settings. For more information, see the documentation available with your web browser.
- Make sure JavaScript and cookies are enabled in your web browser. For more information, see the documentation available with your web browser.

Check the printer IP address

- To check the IP address of the printer, obtain the IP address by printing a network configuration page. Touch , touch **Setup**, touch **Network**, and then touch **Print Network Settings**.
- Ping the printer using the IP address from the command prompt (Windows) or from Network Utility (Mac OS X). (Network Utility is located in the **Utilities** folder in the **Applications** folder at the top level of the hard disk.)
For example, if the IP address is 123.123.123.123, type the following at the command prompt (Windows):
C:\Ping 123.123.123.123
Or
In Network Utility (Mac OS X), click the **Ping** tab, type the 123.123.123.123 in the box, and then click **Ping**.
If a reply appears, the IP address is correct. If a time-out response appears, the IP address is incorrect.

 **TIP:** If you are using a computer running Windows, you can visit the HP online support website at www.hp.com/go/customer-care. This website provides information and utilities that can help you correct many common printer problems.

Troubleshoot installation issues

If the following topics do not help, see [HP support](#) for information about HP support.

 **TIP:** You can visit the HP online support website at www.hp.com/go/customer-care for information and utilities that can help you correct many common printer problems.

-
- [Hardware installation suggestions](#)
 - [HP software installation suggestions](#)
 - [Solve network problems](#)

Hardware installation suggestions

Check the printer

- Make sure that all packing tape and material have been removed from outside and inside the printer.
- Make sure that the printer is loaded with paper.
- Make sure that no lights are on or blinking except the Ready light, which should be on. If the Attention light is blinking, check for messages on the printer control panel.

Check the hardware connections

- Make sure that any cords and cables that you are using are in good working order.
- Make sure that the power cord is connected securely to both the printer and to a working power outlet.

Check the ink cartridges

Make sure that all of the ink cartridges are firmly installed and aligned in their correct, color-coded slot. A correctly installed ink cartridge should not move when pulled slightly. The printer cannot work if all the ink cartridges are not installed.

HP software installation suggestions

Check the computer system

- Make sure that your computer is running one of the supported operating systems. For more information, see [System requirements](#).
- Make sure that the computer meets at least the minimum system requirements. For more information, see [System requirements](#).
- If you are using a computer running Windows, make sure that the USB drivers have not been disabled in the Windows Device Manager.
- If you are using a computer running Windows, and the computer cannot detect the printer, run the uninstallation utility (util\ccc\uninstall.bat on the installation CD) to perform a complete uninstallation of the printer driver. Restart your computer, and reinstall the printer driver.

Verify installation preliminaries

- Make sure to use the installation CD that contains the correct HP software for your operating system.
- Before installing HP software, make sure that all other programs are closed.
- If the computer does not recognize the path to the CD-ROM drive that you type, make sure that you are specifying the correct drive letter.
- If the computer cannot recognize the installation CD in the CD-ROM drive, inspect the installation CD for damage. You can download the printer driver from the HP web site, www.hp.com/go/customercare. This website provides information and utilities that can help you correct many common printer problems.





NOTE: After correcting any problems, run the installation program again.

Solve network problems

General network troubleshooting

- If you are unable to install the HP software, verify that:
 - All cable connections to the computer and the printer are secure.
 - The network is operational and the network hub, switch, or router is turned on.
 - All applications, including virus protection programs, spyware protection programs, and firewalls, are closed or disabled for computers running Windows.
 - Make sure the printer is installed on the same subnet as the computers that use the printer.
 - If the installation program cannot discover the printer, print the network configuration page and enter the IP address manually in the installation program. For more information, see [Understand the network configuration page](#).
- If you are using a computer running Windows, make sure that the network ports created in the printer driver match the printer IP address:
 - Print the printer's network configuration page. For more information, see [Understand the network configuration page](#).
 - Click **Start**, and then click **Printers** or **Printers and Faxes** or **Devices and Printers**.
 - Or -
 - Click **Start**, click **Control Panel**, and then double-click **Printers**.
 - Right-click the printer icon, click **Properties**, and then click the **Ports** tab.
 - Select the TCP/IP port for the printer, and then click **Configure Port**.
 - Compare the IP address listed in the dialog box and make sure it matches the IP address listed on the network configuration page. If the IP addresses are different, change the IP address in the dialog box to match the address on the network configuration page.
 - Click **OK** twice to save the settings and close the dialog boxes.

To reset the printer's network settings

1. Touch , touch **Setup**, and then touch **Network**. Touch **Restore Network Defaults**, and then touch **Yes**. A message appears stating that the network defaults have been restored.
2. Touch , touch **Setup**, touch **Reports**, and then touch **Print Network Configuration Page** to print the network configuration page and verify that the network settings have been reset.

Understand the Printer Status Report

Use the printer status report to view current printer information and ink cartridge status. Also use the printer status report to help you troubleshoot problems with the printer.

The printer status report also contains a log of recent events.

If you need to call HP, it is often useful to print the printer status report before calling.



1. **Printer Information:** Shows printer information (such as the printer name, model number, serial number, and firmware version number), and the number of pages printed from the trays and accessories.
2. **Ink Delivery System Information:** Shows the estimated ink levels (represented in graphical form as gauges) and the part numbers and warranty expiration dates for the ink cartridges.



NOTE: Ink level warnings and indicators provide estimates for planning purposes only. When you receive a low-ink warning message, consider having a replacement cartridge available to avoid possible printing delays. You do not need to replace cartridges until prompted to do so.

3. **Additional Assistance:** Provides information about where you can go to get more information about the printer, as well as information about how to set up a Fax Text and how to run a Wireless Network Test.

To print the Printer Status Report

From the Home screen, touch  (right arrow), and then touch **Setup**. Touch **Reports**, and then touch **Printer Status Report**.

Understand the network configuration page

If the printer is connected to a network, you can print a network configuration page to view the network settings for the printer. You can use the network configuration page to

help troubleshoot network connectivity problems. If you need to call HP, it is often useful to print this page before calling.

HP Network Configuration Page	
General Information	
Network Status	Offline
Active Connection Type	None
URL of the Embedded Web Server	http://192.168.1.1
Printable Name	HP-1142222222
Hostname	HP19216811
Serial Number	XXXXXXXXXXXX
Admin Password	None Set
802.11 Wireless	
Hardware Address (MAC)	080040000000
Status	Disconnected
Communication Mode	Ad-hoc
Network Name (SSID)	HP-19216811
Port 9100	
Status	Enabled
mDNS	
Status	Enabled
Service Name	HP-19216811
SLP	
Status	Enabled

1. **General Information:** Shows information about the current status and active connection type of the network, and other information, such as the URL of the embedded web server.
2. **802.11 Wireless:** Shows information about your wireless network connection, such as the hostname, IP address, subnet mask, default gateway, and server.
3. **Miscellaneous:** Shows information about more advanced network settings.
 - **Port 9100:** The printer supports raw IP printing through TCP Port 9100. This HP-proprietary TCP/IP port on the printer is the default port for printing. It is accessed by HP software (for example, the HP Standard Port).
 - **IPP:** Internet Printing Protocol (IPP) is a standard network protocol for remote printing. Unlike other remote IP-based protocols, IPP supports access control, authentication, and encryption, allowing for more secure printing.
 - **Bonjour:** Bonjour services (which use mDNS, or Multicast Domain Name System) are typically used on small networks for IP address and name resolution (through UDP port 5353), where a conventional DNS server is not used.
 - **SLP:** Service Location Protocol (SLP) is an Internet standard network protocol that provides a framework to allow networking applications to discover the existence, location, and configuration of networked services in enterprise networks. This protocol simplifies discovery and use of network resources such as printers, web servers, fax machines, video cameras, files systems, backup devices (tape drives), databases, directories, mail servers, calendars.
 - **Microsoft Web Services:** Enable or disable the Microsoft Web Services Dynamic Discovery (WS Discovery) protocols or Microsoft Web Services for Devices (WSD) Print services supported on the printer. Disable unused print services to prevent access through those services.

 **NOTE:** For more information about WS Discovery and WSD Print, visit www.microsoft.com.

To print the network configuration page from the printer control panel

From the Home screen, touch  (right arrow), and then touch **Setup**. Touch **Reports**, and then touch **Network Configuration Page**.

Clear jams

Occasionally, media becomes jammed during a job.

This section contains the following topics:

- [Clear paper jams](#)
- [Avoid paper jams](#)

Clear paper jams

Paper jams can occur either inside the printer or in the automatic document feeder.

 **CAUTION:** To prevent possible damage to the printhead, clear paper jams as soon as possible.

 **TIP:** If you notice poor print quality, clean the printhead. For more information, see [Clean the printhead](#).

Use these steps to clear a paper jam.

To clear a jam inside the printer

1. Remove all media from the output tray.

 **CAUTION:** Trying to clear a paper jam from the front of the printer can damage the print mechanism. Always access and clear paper jams through the rear access panel.

2. Check the rear access panel.
 - a. Push the left end of the rear access panel and slide to the right, and then pull the rear access panel towards you.

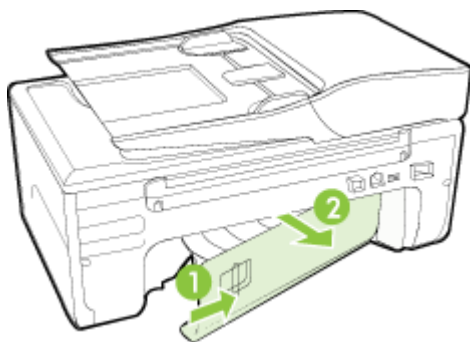

- b. Locate any jammed media inside the printer, grasp it with both hands, and then pull it towards you.

⚠ CAUTION: If the paper tears when you are removing it from the rollers, check the rollers and wheels for torn pieces of paper that might be remaining inside the printer. If you do not remove all the pieces of paper from the printer, more paper jams are likely to occur.

- c. Replace the rear access panel until it snaps into place.
3. Check the front of the printer.
 - a. Open the ink cartridge access door.
 - b. If there is paper remaining inside the printer, ensure the carriage has moved to the right of the printer, free any paper scraps or wrinkled media, and pull the media towards you through the front of the printer.



- c. Move the carriage to the left, locate any jammed media inside the printer on the right side of the carriage, free any paper scraps or wrinkled media, and pull the media towards you through the front of the printer.



⚠ WARNING! Do not reach into the printer when it is turned on and the carriage is stuck. When you open the ink cartridge access door, the carriage should return to its position on the right side of the printer. If it does not move to the right, turn off the printer before you remove any jam.

4. After clearing the jam, close all covers, turn on the printer (if you turned it off) and resend the print job.

To clear a paper jam in the automatic document feeder

1. Lift the cover of the automatic document feeder.

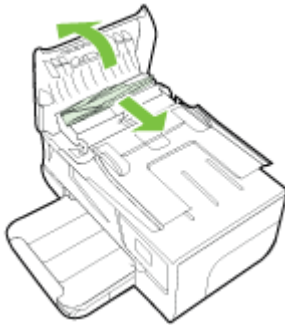

2. Lift the tab located on the front edge of the ADF.
3. Gently pull the paper out of the rollers.

⚠ CAUTION: If the paper tears when you are removing it from the rollers, check the rollers and wheels for torn pieces of paper that might remain inside the printer. If you do not remove all the pieces of paper from the printer, more paper jams are likely to occur.

4. Close the cover of the automatic document feeder, pressing down firmly until it snaps into place.

Avoid paper jams

To help avoid paper jams, follow these guidelines.

- Remove printed papers from the output tray frequently.
- Make sure that you are printing with media that is not wrinkled, folded, or damaged.
- Prevent curled or wrinkled paper by storing all unused paper flat in a resealable bag.
- Do not use paper that is too thick or too thin for the printer.
- Make sure that the trays are loaded correctly and are not too full. For more information, see [Load media](#).
- Ensure that paper loaded in the input tray lays flat and the edges are not bent or torn.
- Do not place too much paper in the document feeder tray. For information on the maximum number of sheets allowed in the automatic document feeder, see [Media specifications](#).
- Do not combine different paper types and paper sizes in the input tray; the entire stack of paper in the input tray must be the same size and type.
- Adjust the paper-width guides in the input tray to fit snugly against all paper. Make sure the paper-width guides do not bend the paper in the input tray.
- Do not force paper too far forward in the input tray.

- Use paper types that are recommended for the printer. For more information, see [Media specifications](#).
- If the printer is about to run out of paper, allow the printer to run out of paper first, and then add paper. Do not try to add paper when the printer is trying to pick up a sheet.
- Make sure that the printer is clean. For more information, see [Maintain the printer](#).

A Technical information

This section contains the following topics:

- [Warranty information](#)
- [Printer specifications](#)
- [Regulatory information](#)
- [Environmental product stewardship program](#)
- [Third-party licenses](#)

Warranty information

This section contains the following topics:

- [Hewlett-Packard limited warranty statement](#)
- [Ink cartridge warranty information](#)

Hewlett-Packard limited warranty statement

HP product	Duration of limited warranty
Software Media	90 days
Printer	1 year
Print or Ink cartridges	Until the HP Ink is depleted or the "end of warranty" date printed on the cartridge has been reached, whichever occurs first. This warranty does not cover HP Ink products that have been refilled, remanufactured, refurbished, misused, or tampered with.
Printheads (only applies to products with customer replaceable printheads)	1 year
Accessories	1 year unless otherwise stated

A. Extent of limited warranty

- Hewlett-Packard (HP) warrants to the end-user customer that the HP products specified above will be free from defects in materials and workmanship for the duration specified above, which duration begins on the date of purchase by the customer.
- For software products, HP's limited warranty applies only to a failure to execute programming instructions. HP does not warrant that the operation of any product will be interrupted or error free.
- HP's limited warranty covers only those defects that arise as a result of normal use of the product, and does not cover any other problems, including those that arise as a result of:
 - Improper maintenance or modification;
 - Software, media, parts, or supplies not provided or supported by HP;
 - Operation outside the product's specifications;
 - Unauthorized modification or misuse.
- For HP printer products, the use of a non-HP cartridge or a refilled cartridge does not affect either the warranty to the customer or any HP support contract with the customer. However, if printer failure or damage is attributable to the use of a non-HP or refilled cartridge or an expired ink cartridge, HP will charge its standard time and materials charges to service the printer for the particular failure or damage.
- If HP receives, during the applicable warranty period, notice of a defect in any product which is covered by HP's warranty, HP shall either repair or replace the product, at HP's option.
- If HP is unable to repair or replace, as applicable, a defective product which is covered by HP's warranty, HP shall, within a reasonable time after being notified of the defect, refund the purchase price for the product.
- HP shall have no obligation to repair, replace, or refund until the customer returns the defective product to HP.
- Any replacement product may be either new or like-new, provided that it has functionality at least equal to that of the product being replaced.
- HP products may contain remanufactured parts, components, or materials equivalent to new in performance.
- HP's Limited Warranty Statement is valid in any country where the covered HP product is distributed by HP. Contracts for additional warranty services, such as on-site service, may be available from any authorized HP service facility in countries where the product is distributed by HP or by an authorized importer.

B. Limitations of warranty

TO THE EXTENT ALLOWED BY LOCAL LAW, NEITHER HP NOR ITS THIRD PARTY SUPPLIERS MAKES ANY OTHER WARRANTY OR CONDITION OF ANY KIND, WHETHER EXPRESS OR IMPLIED WARRANTIES OR CONDITIONS OF MERCHANTABILITY, SATISFACTORY QUALITY, AND FITNESS FOR A PARTICULAR PURPOSE.

C. Limitations of liability

- To the extent allowed by local law, the remedies provided in this Warranty Statement are the customer's sole and exclusive remedies.
- TO THE EXTENT ALLOWED BY LOCAL LAW, EXCEPT FOR THE OBLIGATIONS SPECIFICALLY SET FORTH IN THIS WARRANTY STATEMENT, IN NO EVENT SHALL HP OR ITS THIRD PARTY SUPPLIERS BE LIABLE FOR DIRECT, INDIRECT, SPECIAL, INCIDENTAL, OR CONSEQUENTIAL DAMAGES, WHETHER BASED ON CONTRACT, TORT, OR ANY OTHER LEGAL THEORY AND WHETHER ADVISED OF THE POSSIBILITY OF SUCH DAMAGES.

D. Local law

- This Warranty Statement gives the customer specific legal rights. The customer may also have other rights which vary from state to state in the United States, from province to province in Canada, and from country to country elsewhere in the world.
- To the extent that this Warranty Statement is inconsistent with local law, this Warranty Statement shall be deemed modified to be consistent with such local law. Under such local law, certain disclaimers and limitations of this Warranty Statement may not apply to the customer. For example, some states in the United States, as well as some governments outside the United States (including provinces in Canada), may:
 - Preclude the disclaimers and limitations in this Warranty Statement from limiting the statutory rights of a consumer (e.g., the United Kingdom);
 - Otherwise restrict the ability of a manufacturer to enforce such disclaimers or limitations; or
 - Grant the customer additional warranty rights, specify the duration of implied warranties which the manufacturer cannot disclaim, or allow limitations on the duration of implied warranties.
- THE TERMS IN THIS WARRANTY STATEMENT, EXCEPT TO THE EXTENT LAWFULLY PERMITTED, DO NOT EXCLUDE, RESTRICT, OR MODIFY, AND ARE IN ADDITION TO, THE MANDATORY STATUTORY RIGHTS APPLICABLE TO THE SALE OF THE HP PRODUCTS TO SUCH CUSTOMERS.

HP Limited Warranty

The name and address of the HP entity responsible for the performance of the HP Limited Warranty in your country is as follows:

United Kingdom: Hewlett-Packard Ltd Cain Road Bracknell GB-Berks RG12 1HN

Eire: Hewlett-Packard Ireland Limited, 63-74 Sir John Rogerson's Quay, Dublin 2

Malta: Hewlett-Packard International Trade B.V. Malta Branch, 48, Amery Street, Sliema SLM 1701, MALTA

You may have additional statutory rights against the seller based on your purchase agreement. Those rights are not in any way affected by this HP Limited Warranty.

Ink cartridge warranty information

The HP cartridge warranty is applicable when the product is used in its designated HP printing . This warranty does not cover HP ink products that have been refilled, remanufactured, refurbished, misused, or tampered with.

During the warranty period the product is covered as long as the HP ink is not depleted and the end of warranty date has not been reached. The end of warranty date, in YYYY-MM format, may be found on the product as indicated:

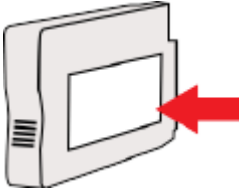

Printer specifications

This section contains the following topics:

- [Physical specifications](#)
- [Product features and capacities](#)
- [Processor and memory specifications](#)
- [System requirements](#)
- [Network protocol specifications](#)
- [Embedded web server specifications](#)
- [Media specifications](#)
- [Print specifications](#)
- [Copy specifications](#)
- [Fax specifications](#)
- [Scan specifications](#)
- [Web Services specifications](#)
- [HP website specifications](#)
- [Environmental specifications](#)
- [Electrical specifications](#)
- [Acoustic emission specifications](#)

Physical specifications

Printer size (width x height x depth)

464 x 253 x 449 mm (18.3 x 10.0 x 17.7 inches)

Printer weight (including printing supplies)

8.3 kg (18.2 lb)

Product features and capacities

Feature	Capacity
Connectivity	<ul style="list-style-type: none">• USB 2.0 high speed• Wireless 802.11b/g/n ¹ <p>¹ This product supports the 802.11n 2.4 GHz frequency band.</p>
Ink cartridges	Four ink cartridges (one each for black, cyan, magenta, and yellow) NOTE: Not all ink cartridges are supported in all countries/regions.
Supply yields	Visit www.hp.com/go/learnaboutsupplies/ for more information on estimated ink cartridge yields.
Printer languages	HP PCL 3
Font support	US fonts: CG Times, CG Times Italic, Universe, Universe Italic, Courier, Courier Italic, Letter Gothic, Letter Gothic Italic.
Duty cycle	Up to 12,000 pages per month

(continued)

Feature	Capacity
Printer control panel language support Language availability varies by country/region.	Bulgarian, Croatian, Czech, Danish, Dutch, English, Finnish, French, German, Greek, Hungarian, Italian, Japanese, Korean, Norwegian, Polish, Portuguese, Romanian, Russian, Simplified Chinese, Slovak, Slovenian, Spanish, Swedish, Traditional Chinese, Turkish.

Processor and memory specifications

Printer processor

ARM R4

Printer memory

128 MB built-in RAM

System requirements



NOTE: For the most current information about supported operating systems and system requirements, visit www.hp.com/go/customercare.

Operating system compatibility

- Windows XP Service Pack 3, Windows Vista, Windows 7
- Mac OS X v10.5, v10.6, v10.7
- Linux (For more information, see <http://hplipopensource.com/hplip-web/index.html>)

Minimum system requirements

- Microsoft® Windows® 7: 1 GHz 32-bit (x86) or 64-bit (x64) processor; 2 GB hard disk space, CD-ROM/DVD drive or Internet connection, USB port; Internet Explorer
- Microsoft Windows Vista®: 800 MHz 32-bit (x86) or 64-bit (x64) processor; 2 GB hard disk space, CD-ROM/DVD drive or Internet connection, USB port; Internet Explorer
- Microsoft Windows XP Service Pack 3 or higher (32-bit only): Intel® Pentium® II, Celeron®, or compatible processor; 233 MHz or higher; CD-ROM/DVD drive or Internet connection, USB port, Internet Explorer 6.0 or higher
- Mac OS X v10.5, v10.6, v10.7: PowerPC G4, G5, or Intel Core processor, 900 MB free hard disk space, CD-ROM/DVD drive or Internet connection, USB port

Network protocol specifications

Network operating system compatibility

- Windows XP (32-bit) (Professional and Home Editions), Windows Vista 32-bit and 64-bit (Ultimate Edition, Enterprise Edition and Business Edition), Windows 7 (32-bit and 64-bit)
- Windows Small Business Server 2003 32-bit and 64-bit, Windows 2003 Server 32-bit and 64-bit, Windows 2003 Server R2 32-bit and 64-bit (Standard Edition, Enterprise Edition)
- Windows Small Business Server 2008 64-bit, Windows 2008 Server 32-bit and 64-bit, Windows 2008 Server R2 64-bit (Standard Edition, Enterprise Edition)
- Citrix XenDesktop 4
- Citrix XenServer 5.5
- Mac OS X v10.5, v10.6, v10.7
- Microsoft Windows 2003 Server Terminal Services
- Microsoft Windows 2003 Server Terminal Services with Citrix Presentation Server 4.0
- Microsoft Windows 2003 Server Terminal Services with Citrix Presentation Server 4.5

- Microsoft Windows 2003 Server Terminal Services with Citrix XenApp 5.0
- Microsoft Windows 2003 Server Terminal Services with Citrix Metaframe XP with Feature Release 3
- Microsoft Windows 2003 Small Business Server Terminal Services
- Microsoft Windows Server 2008 Terminal Services
- Microsoft Windows Small Business Server 2008 Terminal Services
- Microsoft Windows 2008 Server Terminal Services with Citrix XenApp 5.0
- Novell Netware 6.5, Open Enterprise Server 2

Compatible network protocols

TCP/IP

Network management

Embedded web server (Ability to remotely configure and manage network printers)

Embedded web server specifications

Requirements

- A TCP/IP-based network (IPX/SPX-based networks are not supported)
- A web browser (either Microsoft Internet Explorer 7.0 or higher, Mozilla Firefox 3.0 or higher, Safari 3.0 or higher, or Google Chrome 3.0 or higher)
- A network connection (cannot be used with a printer connected to a computer using a USB cable)
- An Internet connection (required for some features)



NOTE: You can open the embedded web server without being connected to the Internet. However, some features are not available.

NOTE: The embedded web server must be on the same side of a firewall as the printer.

Media specifications

Use these tables to determine the correct media to use with your printer, and determine what features work with your media.

- [Understand specifications for supported media](#)
- [Set minimum margins](#)

Understand specifications for supported media

Use the tables to determine the correct media to use with your printer, and to determine what features work with your media.

- [Understand supported sizes](#)
- [Understand supported media types and weights](#)

Understand supported sizes

Media size	Input tray	ADF
Standard media sizes		
10x15cm*	✓	
2L	✓	

(continued)

Media size	Input tray	ADF
U.S. Letter (216 x 279 mm; 8.5 x 11 inches)	✓	✓
8.5 x 13 inches (216 x 330 mm)	✓	✓
U.S. Legal (216 x 356 mm; 8.5 x 14 inches)	✓	✓
A4 (210 x 297 mm; 8.3 x 11.7 inches)*	✓	✓
U.S. Executive (184 x 267 mm; 7.25 x 10.5 inches)	✓	✓
U.S. Statement (140 x 216 mm; 5.5 x 8.5 inches)	✓	✓
B5 (JIS) (182 x 257 mm; 7.17 x 10.12 inches)*	✓	✓
A5 (148 x 210 mm; 5.8 x 8.3 inches)*	✓	✓
Edge-to-Edge A4*	✓	
Edge-to-Edge Letter*	✓	
Envelopes		
U.S. #10 Envelope (105 x 241 mm; 4.12 x 9.5 inches)	✓	
Monarch Envelope (98 x 191 mm; 3.88 x 7.5 inches)	✓	
Card Envelope (111 x 152 mm; 4.4 x 6 inches)	✓	
A2 Envelope (111 x 146 mm; 4.37 x 5.75 inches)	✓	
DL Envelope (110 x 220 mm; 4.3 x 8.7 inches)	✓	
C5 Envelope (162 x 229 mm; 6.4 x 9 inches)	✓	
C6 Envelope (114 x 162 mm; 4.5 x 6.4 inches)	✓	
Japanese Envelope Chou #3 (120 x 235 mm; 4.7 x 9.3 inches)	✓	
Japanese Envelope Chou #4 (90 x 205 mm; 3.5 x 8.1 inches)	✓	
Cards		
Index card (76.2 x 127 mm; 3 x 5 inches)	✓	
Index card (102 x 152 mm; 4 x 6 inches)	✓	

(continued)

Media size	Input tray	ADF
Index card (127 x 203 mm; 5 x 8 inches)	✓	
A6 card (105 x 148.5 mm; 4.13 x 5.83 inches)	✓	
A4 index card (210 x 297 mm; 8.3 x 11.7 inches)	✓	
Hagaki** (100 x 148 mm; 3.9 x 5.8 inches)	✓	
Ofuku Hagaki** (200 x 148 mm; 7.8 x 5.8 inches)	✓	
Index Card Letter (216 x 279 mm; 8.5 x 11 inches)	✓	
Photo media		
Photo media (76.2 x 127 mm; 3 x 5 inches)	✓	
Photo media (102 x 152 mm; 4 x 6 inches)	✓	
Photo media (5 x 7 inches)	✓	
Photo media (8 x 10 inches)	✓	
Photo media (8.5 x 11 inches)	✓	
Photo L (89 x 127 mm; 3.5 x 5 inches)	✓	
Photo 2L (127 x 178 mm)	✓	
13 x 18 cm*	✓	
Other media		
NOTE: Defining custom-size media sizes is only available in the HP printing software in Mac OS X.		
Custom-sized media between 76.2 to 216 mm wide and 127 to 356 mm long (3 to 8.5 inches wide and 5 to 14 inches long)	✓	
Custom-sized media (ADF) between 127 to 216 mm wide and 241 to 305 mm long (5 to 8.5 inches wide and 9.5 to 12 inches long)		✓

* These sizes can be used for borderless printing.

** The printer is compatible with plain and inkjet hagaki from Japan Post only. It is not compatible with photo hagaki from Japan Post.

Understand supported media types and weights

Tray	Type	Weight	Capacity
Input tray	Paper	60 to 105 g/m ² (16 to 28 lb bond)	Up to 250 sheets of plain paper (25 mm or 1 inch stacked)
	Photo media	250 g/m ² (66 lb bond)	Up to 100 sheets (17 mm or 0.67 inch stacked)
	Envelopes	75 to 90 g/m ² (20 to 24 lb bond envelope)	Up to 30 sheets (17 mm or 0.67 inch stacked)
	Cards	Up to 200 g/m ² (110 lb index)	Up to 80 cards
Output tray	All supported media		Up to 75 sheets of plain paper (text printing)
Automatic Document Feeder	Paper	60 to 75 g/m ² (16 to 20 lb bond)	35 sheets

Set minimum margins

The document margins must match (or exceed) these margin settings in portrait orientation.

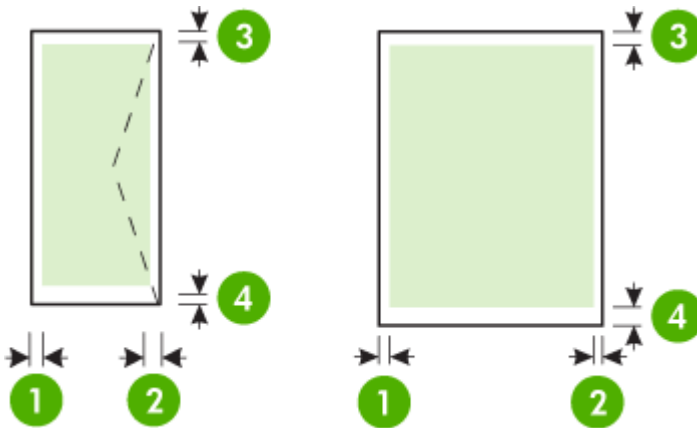

Media	(1) Left margin	(2) Right margin	(3) Top margin	(4) Bottom margin
U.S. Letter	3.3 mm (0.13 inch)	3.3 mm (0.13 inch)	3.3 mm (0.13 inch)	3.3 mm (0.13 inch)
U.S. Legal				Windows and 12mm (0.47 inch)
A4				
U.S. Executive				

(continued)

Media	(1) Left margin	(2) Right margin	(3) Top margin	(4) Bottom margin
U.S. Statement 8.5 x 13 inch B5 A5 Cards Custom-sized media Photo media				Macintosh and Linux
Envelopes	3.3 mm (0.13 inch)	3.3 mm (0.13 inch)	16.5 mm (0.65 inch)	16.5 mm (0.65 inch)

Print specifications

Black print resolution

Up to 600 x 600 dpi with pigmented black ink

Color print resolution

Up to 4800 x 1200 dpi optimized on HP Advanced Photo Paper with 1200 x 1200 input dpi

Copy specifications

- Digital image processing
- Up to 99 copies from original
- Digital zoom: from 25 to 400%
- Fit to page, copy preview

Fax specifications

- Walk-up black-and-white and color fax capability.
- Up to 99 speed dials.
- Up to 100-page memory (based on ITU-T Test Image #1 at standard resolution). More complicated pages or higher resolution takes longer and uses more memory.
- Manual fax send and receive.
- Automatic busy redial up to five times (varies by model).
- Automatic no-answer redial one time (varies by model).
- Confirmation and activity reports.
- CCITT/ITU Group 3 fax with Error Correction Mode.
- 33.6 Kbps transmission.
- 4 seconds per page speed at 33.6 Kbps (based on ITU-T Test Image #1 at standard resolution). More complicated pages or higher resolution takes longer and uses more memory.
- Ring detect with automatic fax/answering machine switching.

	Photo (dpi)	Very Fine (dpi)	Fine (dpi)	Standard (dpi)
Black	196 x 203 (8-bit grayscale)	300 x 300	196 x 203	196 x 98
Color	200 x 200	200 x 200	200 x 200	200 x 200

Fax to PC/Fax to Mac Specifications

- Supported file type: Uncompressed TIFF
- Supported fax types: black-and-white faxes

Scan specifications

- Integrated OCR software automatically converts scanned text to editable text
- Twain-compliant interface (Windows) and Image Capture-compliant interface (Mac OS X)
- Resolution:
 - Scanner glass: 1200 x 1200 ppi
 - ADF: 600 x 600 ppi
- Color: 24-bit color, 8-bit grayscale (256 levels of gray)
- Maximum scan size:
 - Scanner glass: 216 x 297 mm (8.5 x 11.7 inches)
 - ADF: 216 x 356 mm (8.5 x 14 inches)

Web Services specifications

An Internet connection using a wireless connection.

HP ePrint

- Maximum size of email and attachments: 5 MB
- Maximum number of attachments: 10



NOTE: The printer's email address must be the only address listed in the "To" line of the email message.

Supported file types:

- PDF
- HTML
- Standard text file formats
- Microsoft Word, PowerPoint
- Image files, such as PNG, JPEG, TIFF, GIF, BMP



NOTE: You might be able to use other types of files with HP ePrint. However, HP cannot guarantee that they correct functionality with the printer because they have not been fully tested.

Printer Apps

To use certain Printer Apps, you might need to set up an account with a partner website. For more information, visit www.eprintcenter.com.

HP website specifications

- A web browser (either Microsoft Internet Explorer 6.0 or higher, Mozilla Firefox 2.0 or higher, Safari 3.2.3 or higher, or Google Chrome 3.0) with the Adobe Flash plug-in (version 10 or higher).
- An Internet connection

Environmental specifications

Operating environment

Operating temperature: 5° to 40° C (41° to 104° F)

Recommended operating conditions: 15° to 32° C (59° to 90° F)

Recommended relative humidity: 20 to 80% noncondensing

Storage environment

Storage temperature: -40° to 60° C (-40° to 140° F)

Storage relative humidity: Up to 90% noncondensing at a temperature of 60° C (140° F)

Electrical specifications**Power supply**

Universal power adapter (external)

Power requirements

Input voltage: 100 to 240 VAC, 50/60 Hz

Output voltage: +32V/+12V at 1094 mA/250 mA

Power consumption

26.64 watts printing (Fast Draft Mode); 17.76 watts copying (Fast Draft Mode)

Acoustic emission specifications

Print in Draft mode, noise levels per ISO 7779

- Sound pressure (bystander position)
LpAm 55 (dBA) (mono Draft print)
- Sound power
LwAd 6.8 (BA)

Regulatory information

The printer meets product requirements from regulatory agencies in your country/region.

This section contains the following topics:

- [Regulatory Model Number](#)
- [FCC statement](#)
- [Notice to users in Korea](#)
- [VCCI \(Class B\) compliance statement for users in Japan](#)
- [Notice to users in Japan about the power cord](#)
- [Noise emission statement for Germany](#)
- [LED indicator statement](#)
- [Gloss of housing of peripheral devices for Germany](#)
- [Notice to users of the U.S. telephone network: FCC requirements](#)
- [Notice to users of the Canadian telephone network](#)
- [Notice to users of the German telephone network](#)
- [Australia wired fax statement](#)
- [European Union Regulatory Notice](#)
- [Regulatory information for wireless products](#)

Regulatory Model Number

For regulatory identification purposes, your product is assigned a Regulatory Model Number. The Regulatory Model Number for your product is SDGOB-1051. This regulatory number should not be confused with the marketing name (HP Officejet 6600 e-All-in-One series) or product number (CZ155A, CZ160A, CZ161A, CZ162A, or CZ163A).

FCC statement

FCC statement

The United States Federal Communications Commission (in 47 CFR 15.105) has specified that the following notice be brought to the attention of users of this product.

This equipment has been tested and found to comply with the limits for a Class B digital device, pursuant to Part 15 of the FCC Rules. These limits are designed to provide reasonable protection against harmful interference in a residential installation. This equipment generates, uses and can radiate radio frequency energy and, if not installed and used in accordance with the instructions, may cause harmful interference to radio communications. However, there is no guarantee that interference will not occur in a particular installation. If this equipment does cause harmful interference to radio or television reception, which can be determined by turning the equipment off and on, the user is encouraged to try to correct the interference by one or more of the following measures:

- Reorient or relocate the receiving antenna.
- Increase the separation between the equipment and the receiver.
- Connect the equipment into an outlet on a circuit different from that to which the receiver is connected.
- Consult the dealer or an experienced radio/TV technician for help.

For further information, contact:

Manager of Corporate Product Regulations
Hewlett-Packard Company
3000 Hanover Street
Palo Alto, Ca 94304
(650) 857-1501

Modifications (part 15.21)

The FCC requires the user to be notified that any changes or modifications made to this device that are not expressly approved by HP may void the user's authority to operate the equipment.

This device complies with Part 15 of the FCC Rules. Operation is subject to the following two conditions: (1) this device may not cause harmful interference, and (2) this device must accept any interference received, including interference that may cause undesired operation.

Notice to users in Korea

8급 기기 (가정용 방송통신기기)	이 기기는 가정용(8급)으로 전자파적합등록을 한 기기로서 주로 가정에서 사용하는 것을 목적으로 하며, 모든 지역에서 사용할 수 있습니다.
-----------------------	--

VCCI (Class B) compliance statement for users in Japan

この装置は、クラスB情報技術装置です。この装置は、家庭環境で使用することを目的としていますが、この装置がラジオやテレビジョン受信機に近接して使用されると、受信障害を引き起こすことがあります。取扱説明書に従って正しい取り扱いをして下さい。

VCCI-B

Notice to users in Japan about the power cord

製品には、同梱された電源コードをお使い下さい。
同梱された電源コードは、他の製品では使用出来ません。

Noise emission statement for Germany

Geräuschemission

LpA < 70 dB am Arbeitsplatz im Normalbetrieb nach DIN 45635 T. 19

LED indicator statement

LED indicator statement

The display LEDs meet the requirements of EN 60825-1.

Gloss of housing of peripheral devices for Germany

Das Gerät ist nicht für die Benutzung im unmittelbaren Gesichtsfeld am Bildschirmarbeitsplatz vorgesehen. Um störende Reflexionen am Bildschirmarbeitsplatz zu vermeiden, darf dieses Produkt nicht im unmittelbaren Gesichtsfeld positioniert werden.

Notice to users of the U.S. telephone network: FCC requirements

Notice to users of the U.S. telephone network: FCC requirements

This equipment complies with FCC rules, Part 68. On this equipment is a label that contains, among other information, the FCC Registration Number and Ringer Equivalent Number (REN) for this equipment. If requested, provide this information to your telephone company.

An FCC compliant telephone cord and modular plug is provided with this equipment. This equipment is designed to be connected to the telephone network or premises wiring using a compatible modular jack which is Part 68 compliant. This equipment connects to the telephone network through the following standard network interface jack: USOC RJ-11C.

The REN is useful to determine the quantity of devices you may connect to your telephone line and still have all of those devices ring when your number is called. Too many devices on one line might result in failure to ring in response to an incoming call. In most, but not all, areas the sum of the RENs of all devices should not exceed five (5). To be certain of the number of devices you may connect to your line, as determined by the REN, you should call your local telephone company to determine the maximum REN for your calling area.

If this equipment causes harm to the telephone network, your telephone company might discontinue your service temporarily. If possible, they will notify you in advance. If advance notice is not practical, you will be notified as soon as possible. You will also be advised of your right to file a complaint with the FCC. Your telephone company might make changes in its facilities, equipment, operations, or procedures that could affect the proper operation of your equipment. If they do, you will be given advance notice so you will have the opportunity to maintain uninterrupted service. If you experience trouble with this equipment, please contact the manufacturer, or look elsewhere in this manual, for warranty or repair information. Your telephone company might ask you to disconnect this equipment from the network until the problem has been corrected or until you are sure that the equipment is not malfunctioning.

This equipment may not be used on coin service provided by the telephone company.

Connection to party lines is subject to state tariffs. Contact your state public utility commission, public service commission, or corporation commission for more information.

This equipment includes automatic dialing capability. When programming and/or making test calls to emergency numbers:

- Remain on the line and explain to the dispatcher the reason for the call.
- Perform such activities in the off-peak hours, such as early morning or late evening.

Note The FCC hearing aid compatibility rules for telephones are not applicable to this equipment.



The Telephone Consumer Protection Act of 1991 makes it unlawful for any person to use a computer or other electronic device, including fax machines, to send any message unless such message clearly contains in a margin at the top or bottom of each transmitted page or on the first page of transmission, the date and time it is sent and an identification of the business, other entity, or other individual sending the message and the telephone number of the sending machine or such business, other entity, or individual. (The telephone number provided might not be a 900 number or any other number for which charges exceed local or long-distance transmission charges.) In order to program this information into your fax machine, you should complete the steps described in the software.

Notice to users of the Canadian telephone network

Note à l'attention des utilisateurs du réseau téléphonique canadien/Notice to users of the Canadian telephone network

Cet appareil est conforme aux spécifications techniques des équipements terminaux d'Industrie Canada. Le numéro d'enregistrement atteste de la conformité de l'appareil. L'abréviation IC qui précède le numéro d'enregistrement indique que l'enregistrement a été effectué dans le cadre d'une Déclaration de conformité stipulant que les spécifications techniques d'Industrie Canada ont été respectées. Néanmoins, cette abréviation ne signifie en aucun cas que l'appareil a été validé par Industrie Canada.

Pour leur propre sécurité, les utilisateurs doivent s'assurer que les prises électriques reliées à la terre de la source d'alimentation, des lignes téléphoniques et du circuit métallique d'alimentation en eau sont, le cas échéant, branchées les unes aux autres. Cette précaution est particulièrement importante dans les zones rurales.



Remarque Le numéro REN (Ringer Equivalence Number) attribué à chaque appareil terminal fournit une indication sur le nombre maximal de terminaux qui peuvent être connectés à une interface téléphonique. La terminaison d'une interface peut se composer de n'importe quelle combinaison d'appareils, à condition que le total des numéros REN ne dépasse pas 5.

Basé sur les résultats de tests FCC Partie 68, le numéro REN de ce produit est 0.0B.

This equipment meets the applicable Industry Canada Terminal Equipment Technical Specifications. This is confirmed by the registration number. The abbreviation IC before the registration number signifies that registration was performed based on a Declaration of Conformity indicating that Industry Canada technical specifications were met. It does not imply that Industry Canada approved the equipment.

Users should ensure for their own protection that the electrical ground connections of the power utility, telephone lines and internal metallic water pipe system, if present, are connected together. This precaution might be particularly important in rural areas.



Note The REN (Ringer Equivalence Number) assigned to each terminal device provides an indication of the maximum number of terminals allowed to be connected to a telephone interface. The termination on an interface might consist of any combination of devices subject only to the requirement that the sum of the Ringer Equivalence Numbers of all the devices does not exceed 5.

The REN for this product is 0.0B, based on FCC Part 68 test results.

Notice to users of the German telephone network

Hinweis für Benutzer des deutschen Telefonnetzes

Dieses HP-Fax ist nur für den Anschluss eines analogen Public Switched Telephone Network (PSTN) gedacht. Schließen Sie den TAE N-Telefonstecker, der im Lieferumfang des HP All-in-One enthalten ist, an die Wandsteckdose (TAE 6) Code N an. Dieses HP-Fax kann als einzelnes Gerät und/oder in Verbindung (mit seriellen Anschluss) mit anderen zugelassenen Endgeräten verwendet werden.

Australia wired fax statement

In Australia, the HP device must be connected to Telecommunication Network through a line cord which meets the requirements of the Technical Standard AS/ACIF S00B.

European Union Regulatory Notice



Products bearing the CE marking comply with one or more of the following EU Directives as may be applicable: Low Voltage Directive 2006/95/EC, EMC Directive 2004/108/EC, Ecodesign Directive 2009/125/EC, R&TTE Directive 1999/5/EC, RoHS Directive 2011/65/EU. Compliance with these directives is assessed using applicable European Harmonised Standards. The full Declaration of Conformity can be found at the following website: www.hp.com/go/certificates (Search with the product model name or its Regulatory Model Number (RMN), which may be found on the regulatory label.)

The point of contact for regulatory matters is:

Hewlett-Packard GmbH, Dept./MS: HQ-TRE, Herrenberger Strasse 140, 71034 Boeblingen, GERMANY

Products with external AC Adapters

CE compliance of this product is valid only if powered with the correct CE-marked AC adapter provided by HP.

Products with wireless functionality

EMF

This product meets international guidelines (ICNIRP) for exposure to radio frequency radiation. If it incorporates a radio transmitting and receiving device then in normal use, a separation distance of 20 cm ensures that radio frequency exposure levels comply with EU requirements.

Wireless functionality in Europe

This product is designed for use without restrictions in all EU countries plus Iceland, Liechtenstein, Norway and Switzerland.

European telephone network declaration (Modem/Fax)

HP products with FAX capability comply with the requirements of the R&TTE Directive 1999/5/EC (Annex II) and carry the CE marking accordingly. However, due to differences between the individual PSTNs provided in different countries/regions, the approval does not, of itself, give an unconditional assurance of successful operation on every PSTN network termination point. In the event of problems, you should contact your equipment supplier in the first instance.

Regulatory information for wireless products

This section contains the following regulatory information pertaining to wireless products:

- [Exposure to radio frequency radiation](#)
- [Notice to users in Brazil](#)
- [Notice to users in Canada](#)
- [Notice to users in Taiwan](#)

Exposure to radio frequency radiation

Exposure to radio frequency radiation

 **Caution** The radiated output power of this device is far below the FCC radio frequency exposure limits. Nevertheless, the device shall be used in such a manner that the potential for human contact during normal operation is minimized. This product and any attached external antenna, if supported, shall be placed in such a manner to minimize the potential for human contact during normal operation. In order to avoid the possibility of exceeding the FCC radio frequency exposure limits, human proximity to the antenna shall not be less than 20 cm (8 inches) during normal operation.

Notice to users in Brazil

Aviso aos usuários no Brasil

Este equipamento opera em caráter secundário, isto é, não tem direito à proteção contra interferência prejudicial, mesmo de estações do mesmo tipo, e não pode causar interferência a sistemas operando em caráter primário. (Res.ANATEL 282/2001).

Notice to users in Canada

Notice to users in Canada/Note à l'attention des utilisateurs canadiens

For Indoor Use. This digital apparatus does not exceed the Class B limits for radio noise emissions from the digital apparatus set out in the Radio Interference Regulations of the Canadian Department of Communications. The internal wireless radio complies with RSS 210 and RSS GEN of Industry Canada.

Utiliser à l'intérieur. Le présent appareil numérique n'émet pas de bruit radioélectrique dépassant les limites applicables aux appareils numériques de la classe B prescrites dans le Règlement sur le brouillage radioélectrique édicté par le ministère des Communications du Canada. Le composant RF interne est conforme à la norme RSS-210 and RSS GEN d'Industrie Canada.

Notice to users in Taiwan

低功率電波輻射性電機管理辦法

第十二條

經型式認證合格之低功率射頻電機，非經許可，公司、商號或使用者均不得擅自變更頻率、加大功率或變更設計之特性及功能。

第十四條

低功率射頻電機之使用不得影響飛航安全及干擾合法通信；經發現有干擾現象時，應立即停用，並改善至無干擾時方得繼續使用。

前項合法通信，指依電信法規定作業之無線電通信。低功率射頻電機須忍受合法通信或工業、科學及醫藥用電波輻射性電機設備之干擾。

Environmental product stewardship program

Hewlett-Packard is committed to providing quality products in an environmentally sound manner. Design for recycling has been incorporated into this product. The number of materials has been kept to a minimum while ensuring proper functionality and reliability. Dissimilar materials have been designed to separate easily. Fasteners and other connections are easy to locate, access, and remove using common tools. High priority parts have been designed to access quickly for efficient disassembly and repair.

For more information, visit HP's Commitment to the Environment web site at:

www.hp.com/hpinfo/globalcitizenship/environment/index.html

This section contains the following topics:

- [Paper use](#)
- [Plastics](#)
- [Material safety data sheets](#)
- [Recycling program](#)
- [HP inkjet supplies recycling program](#)
- [Disposal of waste equipment by users](#)
- [Power consumption](#)
- [Chemical Substances](#)
- [Battery disposal in Taiwan](#)
- [Battery Notice for Brazil](#)
- [Disposal of Waste Electronic Equipment in Brazil](#)
- [Attention California users](#)
- [EU battery directive](#)
- [RoHS notices \(China only\)](#)
- [RoHS notices \(Ukraine only\)](#)
- [Restriction of hazardous substance \(India\)](#)

Paper use

This product is suited for the use of recycled paper according to DIN 19309 and EN 12281:2002.

Plastics

Plastic parts over 25 grams are marked according to international standards that enhance the ability to identify plastics for recycling purposes at the end of product life.

Material safety data sheets

Material safety data sheets (MSDS) can be obtained from the HP web site at:

www.hp.com/go/msds

Recycling program

HP offers an increasing number of product return and recycling programs in many countries/regions, and partners with some of the largest electronic recycling centers throughout the world. HP conserves resources by reselling some of its most popular products. For more information regarding recycling of HP products, please visit:

www.hp.com/hpinfo/globalcitizenship/environment/recycle/

HP inkjet supplies recycling program

HP is committed to protecting the environment. The HP Inkjet Supplies Recycling Program is available in many countries/regions, and lets you recycle used print cartridges and ink cartridges free of charge. For more information, go to the following web site:

www.hp.com/hpinfo/globalcitizenship/environment/recycle/

Disposal of waste equipment by users

	<p>This symbol means do not dispose of your product with your other household waste. Instead, you should protect human health and the environment by handing over your waste equipment to a designated collection point for the recycling of waste electrical and electronic equipment. For more information, please contact your household waste disposal service, or go to http://www.hp.com/recycle.</p>
---	---

Power consumption

Hewlett-Packard printing and imaging equipment marked with the ENERGY STAR® logo is qualified to the U.S. Environmental Protection Agency's ENERGY STAR specifications for imaging equipment. The following mark appears on ENERGY STAR qualified imaging products:



Additional ENERGY STAR qualified imaging product model information is listed at: www.hp.com/go/energystar

Chemical Substances

HP is committed to providing our customers with information about the chemical substances in our products as needed to comply with legal requirements such as REACH (*Regulation EC No 1907/2006 of the European Parliament and the Council*). A chemical information report for this product can be found at: www.hp.com/go/reach

Battery disposal in Taiwan



廢電池請回收

Battery Notice for Brazil

A bateria deste equipamento não foi projetada para ser removida pelo cliente.

Disposal of Waste Electronic Equipment in Brazil



Não descarte o produto eletrônico em lixo comum

Este produto eletroeletrônico e seus componentes não devem ser descartados no lixo comum, pois ambos originam um contaminação com padrões mundiais de restrição a substâncias nocivas, podendo conter ainda que em quantidades mínimas, substâncias impactantes ao meio ambiente.

Após o uso, as pilhas e/ou baterias dos produtos HP deverão ser entregues ao estabelecimento comercial ou rede de assistência técnica autorizada pela HP.

**HEWLETT PACKARD BRASIL LTDA (HP)
AV. JOSÉ LUZ MAZALIN 360 - GALPÃO II - P. ANTE 1
BARRIO RESIDENCIAL BURCK - L. OLAVEMIA, SP - CE P. 13080-000
CNPJ: 61.707.824/0001-88
Contato de informações HP: (11) 4004-7751 ou 0800-FOR751**

Para maiores informações, inclua entre os pontos de download, acesse:
<http://www.hp.com.br/br/tdr>

Attention California users

The battery supplied with this product may contain perchlorate material. Special handling may apply. For more information, go to the following web site:

www.dtsc.ca.gov/hazardouswaste/perchlorate

EU battery directive



English	<p>European Union Battery Directive This product contains a battery that is used to maintain data integrity of real time clock or product settings and is designed to last the life of the product. Any attempt to service or replace this battery should be performed by a qualified service technician.</p>																																																																																																	
French	<p>Directive sur les batteries de l'Union Européenne Ce produit contient une batterie qui permet de maintenir l'intégrité des données pour les paramètres du produit ou l'horloge en temps réel et qui a été conçue pour durer aussi longtemps que le produit. Toute tentative de réparation ou de remplacement de cette batterie doit être effectuée par un technicien qualifié.</p>																																																																																																	
Spanish	<p>Baterías de la Unión Europea Este producto contiene una batería que se utiliza para conservar la integridad de los datos del reloj de tiempo real o la configuración del producto y está diseñada para durar toda la vida útil del producto. El mantenimiento o la sustitución de dicha batería deberá realizarse por un técnico de mantenimiento cualificado.</p>																																																																																																	
German	<p>Batterie-Richtlinie der Europäischen Union Dieses Produkt enthält eine Batterie, die dazu dient, die Datenintegrität der Echtzeituhr sowie der Produkteinstellungen zu erhalten, und die für die Lebensdauer des Produkts ausreicht. Im Bedarfsfall sollte das Instandhalten bzw. Austauschen der Batterie von einem qualifizierten Servicetechniker durchgeführt werden.</p>																																																																																																	
Italian	<p>Direttiva dell'Unione Europea relativa alla raccolta, al trattamento e allo smaltimento di batterie e accumulatori Questo prodotto contiene una batteria utilizzata per preservare l'integrità dei dati dell'orologio in tempo reale o delle impostazioni del prodotto e la sua durata si intende pari a quella del prodotto. Eventuali interventi di riparazione o sostituzione della batteria devono essere eseguiti da un tecnico dell'assistenza qualificato.</p>																																																																																																	
Portuguese	<p>Directiva sobre baterias de la Unión Europea Este producto contiene una batería que se utiliza para conservar la integridad de los datos del reloj de tiempo real o la configuración del producto y está diseñada para durar toda la vida útil del producto. El mantenimiento o la sustitución de dicha batería deberá realizarse por un técnico de mantenimiento cualificado.</p>																																																																																																	
Dutch	<p>EU's batteriedirectiv Dit product bevat een batterij die wordt gebruikt voor een juiste tijdaanduiding van de klok en het behoud van de productieinstellingen. Bovendien is deze ontworpen om gedurende de levensduur van het product mee te gaan. Het onderhoud of de vervanging van deze batterij moet door een gekwalificeerde onderhoudstechnicus worden uitgevoerd.</p>																																																																																																	
Finnish	<p>Smärrelinje Europäisk union pro nakkäädän i bateriemi Tämän tuotteen sisältäessä akkua, jota käytetään reaaliaikaisen kellon toimintaan ja laitteiden asetusten säilyttämiseen. Akku on valmistettu kestämään tuotteen elämänsiikkä. Jos akkua on vaihdettava, vaihtaminen tulee tehdä koulutetun ammattilaisen toimesta.</p>																																																																																																	
Swedish	<p>EU's batteridirektiv Produkten innehåller ett batteri som brukas till att vidlaggahålla datumintegriteten for realtidur eller produktinställningar og er beqvemat till att hålla i hela produktens levnadstid. Service på batteriet eller utskiftning ber forlagget af en utbildad service tekniker.</p>																																																																																																	
Polish	<p>Uniajs baterijs direktiwa Produkt zawiera baterij wykorzystywaną do zachowania integralności danych zegara czasu rzeczywistego lub ustawień produktu, która podtrzymuje działanie produktu. Przegląd lub wymiana baterji powinny byc wykonywane wyłączenie przez uprawnionego technika serwisu.</p>																																																																																																	
Russian	<p>Директива на батерии на Европелскион съюз Този продукт съдържа батерия, която се използва за поддържане на цялостта на данните на реално време или настройките на продукта, създадена на издръжливостта на целия живот на продукта. Сервисът или заместването на батерията трябва да се извършва от квалификиран техник.</p>																																																																																																	
Chinese	<p>有毒有害物质量表 根据中国《电子信息产品污染控制管理办法》</p> <table border="1"> <thead> <tr> <th rowspan="2">零件描述</th> <th colspan="6">有毒有害物质的元素</th> </tr> <tr> <th>铅</th> <th>汞</th> <th>镉</th> <th>六价铬</th> <th>多溴联苯</th> <th>多溴联苯醚</th> </tr> </thead> <tbody> <tr> <td>外壳和外壳*</td> <td>0</td> <td>0</td> <td>0</td> <td>0</td> <td>0</td> <td>0</td> </tr> <tr> <td>橡胶*</td> <td>0</td> <td>0</td> <td>0</td> <td>0</td> <td>0</td> <td>0</td> </tr> <tr> <td>印刷电路板*</td> <td>X</td> <td>0</td> <td>0</td> <td>0</td> <td>0</td> <td>0</td> </tr> <tr> <td>打印头*</td> <td>X</td> <td>0</td> <td>0</td> <td>0</td> <td>0</td> <td>0</td> </tr> <tr> <td>显示屏*</td> <td>X</td> <td>0</td> <td>0</td> <td>0</td> <td>0</td> <td>0</td> </tr> <tr> <td>电源打印头/机盖*</td> <td>0</td> <td>0</td> <td>0</td> <td>0</td> <td>0</td> <td>0</td> </tr> <tr> <td>电动机盖*</td> <td>X</td> <td>0</td> <td>0</td> <td>0</td> <td>0</td> <td>0</td> </tr> <tr> <td>扫描仪*</td> <td>X</td> <td>X</td> <td>0</td> <td>0</td> <td>0</td> <td>0</td> </tr> <tr> <td>两脚配件*</td> <td>X</td> <td>0</td> <td>0</td> <td>0</td> <td>0</td> <td>0</td> </tr> <tr> <td>扫描仪*</td> <td>X</td> <td>0</td> <td>0</td> <td>0</td> <td>0</td> <td>0</td> </tr> <tr> <td>直接热转印打印头*</td> <td>0</td> <td>0</td> <td>0</td> <td>0</td> <td>0</td> <td>0</td> </tr> <tr> <td>外部电源</td> <td>X</td> <td>0</td> <td>0</td> <td>0</td> <td>0</td> <td>0</td> </tr> </tbody> </table> <p>0: 此零件的所有均一材料中包含的这种有毒有害物质量, 含量低于SJ/T11363-2006 的限制 X: 此零件使用的均一材料中至少有一种包含的这种有毒有害物质量, 含量高于SJ/T11363-2006 的限制 注: 环保使用期限的参考标识取决于产品正常工作时的温度和湿度等条件 *以上只适用于使用这些零件的产品</p>	零件描述	有毒有害物质的元素						铅	汞	镉	六价铬	多溴联苯	多溴联苯醚	外壳和外壳*	0	0	0	0	0	0	橡胶*	0	0	0	0	0	0	印刷电路板*	X	0	0	0	0	0	打印头*	X	0	0	0	0	0	显示屏*	X	0	0	0	0	0	电源打印头/机盖*	0	0	0	0	0	0	电动机盖*	X	0	0	0	0	0	扫描仪*	X	X	0	0	0	0	两脚配件*	X	0	0	0	0	0	扫描仪*	X	0	0	0	0	0	直接热转印打印头*	0	0	0	0	0	0	外部电源	X	0	0	0	0	0
零件描述	有毒有害物质的元素																																																																																																	
	铅	汞	镉	六价铬	多溴联苯	多溴联苯醚																																																																																												
外壳和外壳*	0	0	0	0	0	0																																																																																												
橡胶*	0	0	0	0	0	0																																																																																												
印刷电路板*	X	0	0	0	0	0																																																																																												
打印头*	X	0	0	0	0	0																																																																																												
显示屏*	X	0	0	0	0	0																																																																																												
电源打印头/机盖*	0	0	0	0	0	0																																																																																												
电动机盖*	X	0	0	0	0	0																																																																																												
扫描仪*	X	X	0	0	0	0																																																																																												
两脚配件*	X	0	0	0	0	0																																																																																												
扫描仪*	X	0	0	0	0	0																																																																																												
直接热转印打印头*	0	0	0	0	0	0																																																																																												
外部电源	X	0	0	0	0	0																																																																																												

RoHS notices (China only)

Toxic and hazardous substance table

有毒有害物质量表
 根据中国《电子信息产品污染控制管理办法》

零件描述	有毒有害物质的元素					
	铅	汞	镉	六价铬	多溴联苯	多溴联苯醚
外壳和外壳*	0	0	0	0	0	0
橡胶*	0	0	0	0	0	0
印刷电路板*	X	0	0	0	0	0
打印头*	X	0	0	0	0	0
显示屏*	X	0	0	0	0	0
电源打印头/机盖*	0	0	0	0	0	0
电动机盖*	X	0	0	0	0	0
扫描仪*	X	X	0	0	0	0
两脚配件*	X	0	0	0	0	0
扫描仪*	X	0	0	0	0	0
直接热转印打印头*	0	0	0	0	0	0
外部电源	X	0	0	0	0	0

0: 此零件的所有均一材料中包含的这种有毒有害物质量, 含量低于SJ/T11363-2006 的限制
 X: 此零件使用的均一材料中至少有一种包含的这种有毒有害物质量, 含量高于SJ/T11363-2006 的限制
 注: 环保使用期限的参考标识取决于产品正常工作时的温度和湿度等条件
 *以上只适用于使用这些零件的产品

RoHS notices (Ukraine only)

Обладнання відповідає вимогам Технічного регламенту щодо обмеження використання деяких небезпечних речовин в електричному та електронному обладнанні, затвердженого постановою Кабінету Міністрів України від 3 грудня 2008 № 1057

Restriction of hazardous substance (India)

Restriction of hazardous substances (India)

This product complies with the "India E-waste (Management and Handling) Rule 2011" and prohibits use of lead, mercury, hexavalent chromium, polybrominated biphenyls or polybrominated diphenyl ethers in concentrations exceeding 0.1 weight % and 0.01 weight % for cadmium, except for the exemptions set in Schedule 2 of the Rule.

Third-party licenses

LICENSE.aes-pubdom--crypto

/* rijndael-alg-fst.c

*

* @version 3.0 (December 2000)

*

* Optimised ANSI C code for the Rijndael cipher (now AES)

*

* @author Vincent Rijmen <vincent.rijmen@esat.kuleuven.ac.be>

* @author Antoon Bosselaers <antoon.bosselaers@esat.kuleuven.ac.be>

* @author Paulo Barreto <paulo.barreto@terra.com.br>

*

* This code is hereby placed in the public domain.

*

* THIS SOFTWARE IS PROVIDED BY THE AUTHORS "AS IS" AND ANY EXPRESS
* OR IMPLIED WARRANTIES, INCLUDING, BUT NOT LIMITED TO, THE IMPLIED
* WARRANTIES OF MERCHANTABILITY AND FITNESS FOR A PARTICULAR PURPOSE
* ARE DISCLAIMED. IN NO EVENT SHALL THE AUTHORS OR CONTRIBUTORS BE
* LIABLE FOR ANY DIRECT, INDIRECT, INCIDENTAL, SPECIAL, EXEMPLARY, OR
* CONSEQUENTIAL DAMAGES (INCLUDING, BUT NOT LIMITED TO, PROCUREMENT OF
* SUBSTITUTE GOODS OR SERVICES; LOSS OF USE, DATA, OR PROFITS; OR
* BUSINESS INTERRUPTION) HOWEVER CAUSED AND ON ANY THEORY OF LIABILITY,
* WHETHER IN CONTRACT, STRICT LIABILITY, OR TORT (INCLUDING NEGLIGENCE
* OR OTHERWISE) ARISING IN ANY WAY OUT OF THE USE OF THIS SOFTWARE,
* EVEN IF ADVISED OF THE POSSIBILITY OF SUCH DAMAGE.

*/

LICENSE.expatsmit--expat

Copyright (c) 1998, 1999, 2000 Thai Open Source Software Center Ltd

Permission is hereby granted, free of charge, to any person obtaining a copy of this software and associated documentation files (the "Software"), to deal in the Software without restriction, including without limitation the rights to use, copy, modify, merge, publish, distribute, sublicense, and/or sell copies of the Software, and to permit persons to whom the Software is furnished to do so, subject to the following conditions:

The above copyright notice and this permission notice shall be included in all copies or substantial portions of the Software.

THE SOFTWARE IS PROVIDED "AS IS", WITHOUT WARRANTY OF ANY KIND, EXPRESS OR IMPLIED, INCLUDING BUT NOT LIMITED TO THE WARRANTIES OF MERCHANTABILITY, FITNESS FOR A PARTICULAR PURPOSE AND NONINFRINGEMENT. IN NO EVENT SHALL THE AUTHORS OR COPYRIGHT HOLDERS BE LIABLE FOR ANY CLAIM, DAMAGES OR OTHER LIABILITY, WHETHER IN AN ACTION OF CONTRACT, TORT OR OTHERWISE, ARISING FROM, OUT OF OR IN CONNECTION WITH THE SOFTWARE OR THE USE OR OTHER DEALINGS IN THE SOFTWARE.

LICENSE.hmac-sha2-bsd--nos_crypto

/* HMAC-SHA-224/256/384/512 implementation

* Last update: 06/15/2005

* Issue date: 06/15/2005

*

* Copyright (C) 2005 Olivier Gay <olivier.gay@a3.epfl.ch>

* All rights reserved.

*

* Redistribution and use in source and binary forms, with or without

* modification, are permitted provided that the following conditions

* are met:

* 1. Redistributions of source code must retain the above copyright

* notice, this list of conditions and the following disclaimer.

* 2. Redistributions in binary form must reproduce the above copyright

* notice, this list of conditions and the following disclaimer in the

* documentation and/or other materials provided with the distribution.

* 3. Neither the name of the project nor the names of its contributors

* may be used to endorse or promote products derived from this software

* without specific prior written permission.

*

* THIS SOFTWARE IS PROVIDED BY THE PROJECT AND CONTRIBUTORS ``AS IS" AND

* ANY EXPRESS OR IMPLIED WARRANTIES, INCLUDING, BUT NOT LIMITED TO, THE

* IMPLIED WARRANTIES OF MERCHANTABILITY AND FITNESS FOR A PARTICULAR

* PURPOSE ARE DISCLAIMED. IN NO EVENT SHALL THE PROJECT OR CONTRIBUTORS

* BE LIABLE FOR ANY DIRECT, INDIRECT, INCIDENTAL, SPECIAL, EXEMPLARY, OR

* CONSEQUENTIAL DAMAGES (INCLUDING, BUT NOT LIMITED TO, PROCUREMENT OF

* SUBSTITUTE GOODS OR SERVICES; LOSS OF USE, DATA, OR PROFITS; OR

* BUSINESS INTERRUPTION) HOWEVER CAUSED AND ON ANY THEORY OF LIABILITY,

* WHETHER IN CONTRACT, STRICT LIABILITY, OR TORT (INCLUDING NEGLIGENCE OR

* OTHERWISE) ARISING IN ANY WAY OUT OF THE USE OF THIS SOFTWARE, EVEN IF

* ADVISED OF THE POSSIBILITY OF SUCH DAMAGE.

*/

LICENSE.open_ssl--open_ssl

Copyright (C) 1995-1998 Eric Young (eay@cryptsoft.com)

All rights reserved.

This package is an SSL implementation written by Eric Young (eay@cryptsoft.com).

The implementation was written so as to conform with Netscapes SSL.

This library is free for commercial and non-commercial use as long as the following conditions are aheared to. The following conditions apply to all code found in this distribution, be it the RC4, RSA, lhash, DES, etc., code; not just the SSL code. The SSL documentation included with this distribution is covered by the same copyright terms except that the holder is Tim Hudson (tjh@cryptsoft.com).

Copyright remains Eric Young's, and as such any Copyright notices in the code are not to be removed.

If this package is used in a product, Eric Young should be given attribution as the author of the parts of the library used.

This can be in the form of a textual message at program startup or in documentation (online or textual) provided with the package.

Redistribution and use in source and binary forms, with or without modification, are permitted provided that the following conditions are met:

1. Redistributions of source code must retain the copyright notice, this list of conditions and the following disclaimer.
2. Redistributions in binary form must reproduce the above copyright notice, this list of conditions and the following disclaimer in the documentation and/or other materials provided with the distribution.
3. All advertising materials mentioning features or use of this software must display the following acknowledgement:

"This product includes cryptographic software written by Eric Young (eay@cryptsoft.com)"

The word 'cryptographic' can be left out if the rouines from the library being used are not cryptographic related :-).

4. If you include any Windows specific code (or a derivative thereof) from the apps directory (application code) you must include an acknowledgement: "This product includes software written by Tim Hudson (tjh@cryptsoft.com)"

THIS SOFTWARE IS PROVIDED BY ERIC YOUNG ``AS IS" AND ANY EXPRESS OR IMPLIED WARRANTIES, INCLUDING, BUT NOT LIMITED TO, THE IMPLIED WARRANTIES OF MERCHANTABILITY AND FITNESS FOR A PARTICULAR PURPOSE ARE DISCLAIMED. IN NO EVENT SHALL THE AUTHOR OR CONTRIBUTORS BE LIABLE FOR ANY DIRECT, INDIRECT, INCIDENTAL, SPECIAL, EXEMPLARY, OR CONSEQUENTIAL DAMAGES (INCLUDING, BUT NOT LIMITED TO, PROCUREMENT OF SUBSTITUTE GOODS OR SERVICES; LOSS OF USE, DATA, OR PROFITS; OR BUSINESS INTERRUPTION) HOWEVER CAUSED AND ON ANY THEORY OF LIABILITY, WHETHER IN CONTRACT, STRICT LIABILITY, OR TORT (INCLUDING NEGLIGENCE OR OTHERWISE)

ARISING IN ANY WAY OUT OF THE USE OF THIS SOFTWARE, EVEN IF ADVISED OF THE POSSIBILITY OF SUCH DAMAGE.

The licence and distribution terms for any publically available version or derivative of this code cannot be changed. i.e. this code cannot simply be copied and put under another distribution licence [including the GNU Public Licence.]

=====
Copyright (c) 1998-2001 The OpenSSL Project. All rights reserved.

Redistribution and use in source and binary forms, with or without modification, are permitted provided that the following conditions are met:

1. Redistributions of source code must retain the above copyright notice, this list of conditions and the following disclaimer.
2. Redistributions in binary form must reproduce the above copyright notice, this list of conditions and the following disclaimer in the documentation and/or other materials provided with the distribution.
3. All advertising materials mentioning features or use of this software must display the following acknowledgment:
"This product includes software developed by the OpenSSL Project for use in the OpenSSL Toolkit. (<http://www.openssl.org/>)"
4. The names "OpenSSL Toolkit" and "OpenSSL Project" must not be used to endorse or promote products derived from this software without prior written permission. For written permission, please contact openssl-core@openssl.org.
5. Products derived from this software may not be called "OpenSSL" nor may "OpenSSL" appear in their names without prior written permission of the OpenSSL Project.
6. Redistributions of any form whatsoever must retain the following acknowledgment:
"This product includes software developed by the OpenSSL Project for use in the OpenSSL Toolkit (<http://www.openssl.org/>)"

THIS SOFTWARE IS PROVIDED BY THE OpenSSL PROJECT ``AS IS'' AND ANY EXPRESSED OR IMPLIED WARRANTIES, INCLUDING, BUT NOT LIMITED TO, THE IMPLIED WARRANTIES OF MERCHANTABILITY AND FITNESS FOR A PARTICULAR PURPOSE ARE DISCLAIMED. IN NO EVENT SHALL THE OpenSSL PROJECT OR

ITS CONTRIBUTORS BE LIABLE FOR ANY DIRECT, INDIRECT, INCIDENTAL, SPECIAL, EXEMPLARY, OR CONSEQUENTIAL DAMAGES (INCLUDING, BUT NOT LIMITED TO, PROCUREMENT OF SUBSTITUTE GOODS OR SERVICES; LOSS OF USE, DATA, OR PROFITS; OR BUSINESS INTERRUPTION) HOWEVER CAUSED AND ON ANY THEORY OF LIABILITY, WHETHER IN CONTRACT, STRICT LIABILITY, OR TORT (INCLUDING NEGLIGENCE OR OTHERWISE) ARISING IN ANY WAY OUT OF THE USE OF THIS SOFTWARE, EVEN IF ADVISED OF THE POSSIBILITY OF SUCH DAMAGE.

=====

This product includes cryptographic software written by Eric Young (eay@cryptsoft.com). This product includes software written by Tim Hudson (tjh@cryptsoft.com).

=====

Copyright (c) 1998-2006 The OpenSSL Project. All rights reserved.

Redistribution and use in source and binary forms, with or without modification, are permitted provided that the following conditions are met:

1. Redistributions of source code must retain the above copyright notice, this list of conditions and the following disclaimer.
2. Redistributions in binary form must reproduce the above copyright notice, this list of conditions and the following disclaimer in the documentation and/or other materials provided with the distribution.
3. All advertising materials mentioning features or use of this software must display the following acknowledgment:
"This product includes software developed by the OpenSSL Project for use in the OpenSSL Toolkit. (<http://www.openssl.org/>)"
4. The names "OpenSSL Toolkit" and "OpenSSL Project" must not be used to endorse or promote products derived from this software without prior written permission. For written permission, please contact openssl-core@openssl.org.
5. Products derived from this software may not be called "OpenSSL" nor may "OpenSSL" appear in their names without prior written permission of the OpenSSL Project.
6. Redistributions of any form whatsoever must retain the following acknowledgment:

"This product includes software developed by the OpenSSL Project for use in the OpenSSL Toolkit (<http://www.openssl.org/>)"

THIS SOFTWARE IS PROVIDED BY THE OpenSSL PROJECT ``AS IS'' AND ANY EXPRESSED OR IMPLIED WARRANTIES, INCLUDING, BUT NOT LIMITED TO, THE IMPLIED WARRANTIES OF MERCHANTABILITY AND FITNESS FOR A PARTICULAR PURPOSE ARE DISCLAIMED. IN NO EVENT SHALL THE OpenSSL PROJECT OR ITS CONTRIBUTORS BE LIABLE FOR ANY DIRECT, INDIRECT, INCIDENTAL, SPECIAL, EXEMPLARY, OR CONSEQUENTIAL DAMAGES (INCLUDING, BUT NOT LIMITED TO, PROCUREMENT OF SUBSTITUTE GOODS OR SERVICES; LOSS OF USE, DATA, OR PROFITS; OR BUSINESS INTERRUPTION) HOWEVER CAUSED AND ON ANY THEORY OF LIABILITY, WHETHER IN CONTRACT, STRICT LIABILITY, OR TORT (INCLUDING NEGLIGENCE OR OTHERWISE) ARISING IN ANY WAY OUT OF THE USE OF THIS SOFTWARE, EVEN IF ADVISED OF THE POSSIBILITY OF SUCH DAMAGE.

=====

This product includes cryptographic software written by Eric Young (eay@cryptsoft.com). This product includes software written by Tim Hudson (tjh@cryptsoft.com).

=====

Copyright 2002 Sun Microsystems, Inc. ALL RIGHTS RESERVED.
ECC cipher suite support in OpenSSL originally developed by SUN MICROSYSTEMS, INC., and contributed to the OpenSSL project.

LICENSE.sha2-bsd--nos_crypto

- /* FIPS 180-2 SHA-224/256/384/512 implementation
- * Last update: 02/02/2007
- * Issue date: 04/30/2005
- *
- * Copyright (C) 2005, 2007 Olivier Gay <olivier.gay@a3.epfl.ch>
- * All rights reserved.
- *
- * Redistribution and use in source and binary forms, with or without
- * modification, are permitted provided that the following conditions
- * are met:
- * 1. Redistributions of source code must retain the above copyright
- * notice, this list of conditions and the following disclaimer.
- * 2. Redistributions in binary form must reproduce the above copyright
- * notice, this list of conditions and the following disclaimer in the
- * documentation and/or other materials provided with the distribution.
- * 3. Neither the name of the project nor the names of its contributors

* may be used to endorse or promote products derived from this software
* without specific prior written permission.

*

* THIS SOFTWARE IS PROVIDED BY THE PROJECT AND CONTRIBUTORS ``AS IS" AND
* ANY EXPRESS OR IMPLIED WARRANTIES, INCLUDING, BUT NOT LIMITED TO, THE
* IMPLIED WARRANTIES OF MERCHANTABILITY AND FITNESS FOR A PARTICULAR
* PURPOSE ARE DISCLAIMED. IN NO EVENT SHALL THE PROJECT OR CONTRIBUTORS
* BE LIABLE FOR ANY DIRECT, INDIRECT, INCIDENTAL, SPECIAL, EXEMPLARY, OR
* CONSEQUENTIAL DAMAGES (INCLUDING, BUT NOT LIMITED TO, PROCUREMENT OF
* SUBSTITUTE GOODS OR SERVICES; LOSS OF USE, DATA, OR PROFITS; OR BUSINESS
* INTERRUPTION) HOWEVER CAUSED AND ON ANY THEORY OF LIABILITY, WHETHER IN
* CONTRACT, STRICT LIABILITY, OR TORT (INCLUDING NEGLIGENCE OR OTHERWISE)
* ARISING IN ANY WAY OUT OF THE USE OF THIS SOFTWARE, EVEN IF ADVISED OF
* THE POSSIBILITY OF SUCH DAMAGE.

*/

LICENSE.zlib--zlib

zlib.h -- interface of the 'zlib' general purpose compression library
version 1.2.3, July 18th, 2005

Copyright (C) 1995-2005 Jean-loup Gailly and Mark Adler

This software is provided 'as-is', without any express or implied
warranty. In no event will the authors be held liable for any damages
arising from the use of this software.

Permission is granted to anyone to use this software for any purpose,
including commercial applications, and to alter it and redistribute it
freely, subject to the following restrictions:

1. The origin of this software must not be misrepresented; you must not
claim that you wrote the original software. If you use this software
in a product, an acknowledgment in the product documentation would be
appreciated but is not required.
2. Altered source versions must be plainly marked as such, and must not be
misrepresented as being the original software.
3. This notice may not be removed or altered from any source distribution.

Jean-loup Gailly Mark Adler
jloup@gzip.org madler@alumni.caltech.edu

The data format used by the zlib library is described by RFCs (Request for
Comments) 1950 to 1952 in the files <http://www.ietf.org/rfc/rfc1950.txt>
(zlib format), [rfc1951.txt](http://www.ietf.org/rfc/rfc1951.txt) (deflate format) and [rfc1952.txt](http://www.ietf.org/rfc/rfc1952.txt) (gzip format).

B HP supplies and accessories

This section provides information on HP supplies and accessories for the printer. The information is subject to changes, visit the HP web site (www.hpshopping.com) for the latest updates. You may also make purchases through the web site.

 **NOTE:** Not all cartridges are available in all countries/regions.

This section contains the following topics:

- [Order printing supplies online](#)
- [Supplies](#)

Order printing supplies online

To order supplies online or create a printable shopping list, open the HP software that came with your printer and click **Shopping**. Select **Shop for Supplies Online**. The HP software uploads, with your permission, printer information, including model number, serial number, and estimated ink levels. The HP supplies that work in your printer are pre-selected. You can change quantities, add or remove items, and then print the list or purchase online at the HP Store or other online retailers (options differ by country/region). Cartridge information and links to online shopping also appear on ink alert messages.

You can also order online by visiting www.hp.com/buy/supplies. If prompted, select your country/region, follow the prompts to select your printer, and then the supplies you need.

 **NOTE:** Ordering cartridges online is not supported in all countries/regions. However, many countries have information on ordering by telephone, locating a local store and printing a shopping list. In addition, you can select the 'How to Buy' option at the top of the www.hp.com/buy/supplies page to obtain information about purchasing HP products in your country.

Supplies

- [Ink cartridges](#)
- [HP media](#)

Ink cartridges

Ordering cartridges online is not supported in all countries/regions. However, many countries have information on ordering by telephone, locating a local store and printing a shopping list. In addition, you can select the 'How to Buy' option at the top of the www.hp.com/buy/supplies page to obtain information about purchasing HP products in your country.

Use only the replacement cartridges that have the same cartridge number as the ink cartridge you are replacing. You can find the cartridge number in the following places:

- In the embedded web server, by clicking the **Tools** tab, and then, under **Product Information** clicking **Ink Gauge**. For more information, see [Embedded web server](#).
- On the printer status report (see [Understand the Printer Status Report](#)).
- On the label of the ink cartridge you are replacing.
On a sticker inside the printer.

 **CAUTION:** The **Setup** ink cartridge that comes with the printer is not available for separate purchase. Check for the correct cartridge number through the EWS, on the printer status report, or on the sticker inside the printer.



NOTE: Ink level warnings and indicators provide estimates for planning purposes only. When you receive a low-ink warning message, consider having a replacement cartridge available to avoid possible printing delays. You do not need to replace cartridges until prompted to do so.

HP media

To order media such as HP Premium Paper, go to www.hp.com.



HP recommends plain papers with the ColorLok logo for printing and copying of everyday documents. All papers with the ColorLok logo are independently tested to meet high standards of reliability and print quality, and produce documents with crisp, vivid color, bolder blacks, and that dry faster than ordinary plain papers. Look for papers with the ColorLok logo in a variety of weights and sizes from major paper manufacturers.

C Additional fax setup

After completing all the steps in the getting started guide, use the instructions in this section to complete your fax setup. Keep your getting started guide for later use.

In this section, you learn how to set up the printer so that faxing works successfully with equipment and services you might already have on the same phone line.

 **TIP:** You can also use the Fax Setup Wizard (Windows) or HP Setup Assistant (Mac OS X) to help you quickly set up some important fax settings such as the answer mode and fax header information. You can access these tools through the HP software you installed with the printer. After you run these tools, follow the procedures in this section to complete your fax setup.

This section contains the following topics:

- [Set up faxing \(parallel phone systems\)](#)
- [Serial-type fax setup](#)
- [Test fax setup](#)

Set up faxing (parallel phone systems)

Before you begin setting up the printer for faxing, determine which kind of phone system your country/region uses. The instructions for fax setup differ depending on whether you have a serial- or parallel-type phone system.

- If you do not see your country/region listed in the table, you probably have a serial-type phone system. In a serial-type phone system, the connector type on your shared telephone equipment (modems, phones, and answering machines) does not allow a physical connection to the "2-EXT" port on the printer. Instead, all equipment must be connected at the telephone wall jack.

 **NOTE:** In some countries/regions that use serial-type phone systems, the phone cord that came with the printer might have an additional wall plug attached to it. This enables you to connect other telecom devices to the wall jack where you plug in the printer. You might need to connect the supplied phone cord to the adapter provided for your country/region.

- If your country/region is listed in the table, you probably have a parallel-type telephone system. In a parallel-type phone system, you are able to connect shared telephone equipment to the phone line by using the "2-EXT" port on the back of the printer.

 **NOTE:** If you have a parallel-type phone system, HP recommends you use the 2-wire phone cord supplied with the printer to connect it to the telephone wall jack.

Table C-1 Countries/regions with a parallel-type phone system

Argentina	Australia	Brazil
Canada	Chile	China
Colombia	Greece	India
Indonesia	Ireland	Japan
Korea	Latin America	Malaysia

Countries/regions with a parallel-type phone system (continued)

Mexico	Philippines	Poland
Portugal	Russia	Saudi Arabia
Singapore	Spain	Taiwan
Thailand	USA	Venezuela
Vietnam		

If you are unsure which kind of telephone system you have (serial or parallel), check with your telephone company.

This section contains the following topics:

- [Select the correct fax setup for your home or office](#)
- [Case A: Separate fax line \(no voice calls received\)](#)
- [Case B: Set up the printer with DSL](#)
- [Case C: Set up the printer with a PBX phone system or an ISDN line](#)
- [Case D: Fax with a distinctive ring service on the same line](#)
- [Case E: Shared voice/fax line](#)
- [Case F: Shared voice/fax line with voice mail](#)
- [Case G: Fax line shared with computer modem \(no voice calls received\)](#)
- [Case H: Shared voice/fax line with computer modem](#)
- [Case I: Shared voice/fax line with answering machine](#)
- [Case J: Shared voice/fax line with computer modem and answering machine](#)
- [Case K: Shared voice/fax line with computer dial-up modem and voice mail](#)

Select the correct fax setup for your home or office

To fax successfully, you need to know what types of equipment and services (if any) share the same phone line with the printer. This is important because you might need to connect some of your existing office equipment directly to the printer, and you might also need to change some fax settings before you can fax successfully.

1. Determine if your telephone system is serial or parallel. See [Set up faxing \(parallel phone systems\)](#).
 - a. Serial-type telephone system—See [Serial-type fax setup](#).
 - b. Parallel-type telephone system—Go to step 2.
2. Select the combination of equipment and services sharing your fax line.
 - DSL: A Digital subscriber line (DSL) service through your telephone company. (DSL might be called ADSL in your country/region.)
 - PBX: A private branch exchange (PBX) phone system or an integrated services digital network (ISDN) system.
 - Distinctive ring service: A distinctive ring service through your telephone company provides multiple telephone numbers with different ring patterns.
 - Voice calls: Voice calls are received at the same phone number you use for fax calls on the printer.
 - Computer dial-up modem: A computer dial-up modem is on the same phone line as the printer. If you answer Yes to any of the following questions, you are using a computer dial-up modem:
 - Do you send and receive faxes directly to and from your computer software applications through a dial-up connection?
 - Do you send and receive email messages on your computer through a dial-up connection?
 - Do you access the Internet from your computer through a dial-up connection?

- Answering machine: An answering machine that answers voice calls at the same phone number you use for fax calls on the printer.
 - Voice mail service: A voice mail subscription through your telephone company at the same number you use for fax calls on the printer.
3. From the following table, select the combination of equipment and services applicable to your home or office setting. Then look up the recommended fax setup. Step-by-step instructions are included for each case in the sections that follow.

 **NOTE:** If your home or office setup is not described in this section, set up the printer as you would a regular analog phone. Make sure you use the phone cord supplied in the box to connect one end to your telephone wall jack and the other end to the port labeled 1-LINE on the back of the printer. If you use another phone cord, you might experience problems sending and receiving faxes.

You might need to connect the supplied phone cord to the adapter provided for your country/region.

Other equipment or services sharing your fax line							Recommended fax setup
DSL	PBX	Distinctive ring service	Voice calls	Computer dial-up modem	Answering machine	Voice mail service	
							Case A: <u>Separate fax line (no voice calls received)</u>
✓							Case B: <u>Set up the printer with DSL</u>
	✓						Case C: <u>Set up the printer with a PBX phone system or an ISDN line</u>
		✓					Case D: <u>Fax with a distinctive ring service on the same line</u>
			✓				Case E: <u>Shared voice/fax line</u>
			✓			✓	Case F: <u>Shared voice/fax line with voice mail</u>
				✓			Case G: <u>Fax line shared with computer modem (no voice calls received)</u>
			✓	✓			Case H: <u>Shared voice/fax line with computer modem</u>
			✓		✓		Case I: <u>Shared voice/fax line with answering machine</u>

(continued)

Other equipment or services sharing your fax line							Recommended fax setup
DSL	PBX	Distinctive ring service	Voice calls	Computer dial-up modem	Answering machine	Voice mail service	
			✓	✓	✓		Case J: Shared voice/fax line with computer modem and answering machine
			✓	✓		✓	Case K: Shared voice/fax line with computer dial-up modem and voice mail

Case A: Separate fax line (no voice calls received)

If you have a separate phone line on which you receive no voice calls, and you have no other equipment connected on this phone line, set up the printer as described in this section.

Back view of the printer

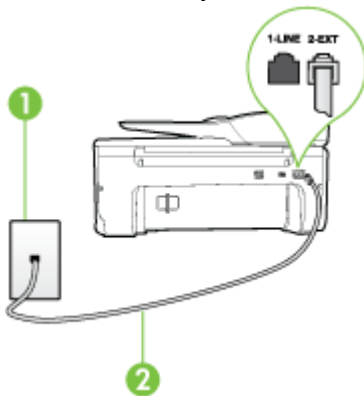

1	Telephone wall jack
2	Use the phone cord supplied in the box with the printer to connect to the 1-LINE port. You might need to connect the supplied phone cord to the adapter provided for your country/region.

To set up the printer with a separate fax line

- Using the phone cord supplied in the box with the printer, connect one end to your telephone wall jack, then connect the other end to the port labeled 1-LINE on the back of the printer.

 **NOTE:** You might need to connect the supplied phone cord to the adapter provided for your country/region.

If you do not use the supplied cord to connect from the telephone wall jack to the printer, you might not be able to fax successfully. This special phone cord is different from the phone cords you might already have in your home or office.

- Turn on the **Auto Answer** setting.
- (Optional) Change the **Rings to Answer** setting to the lowest setting (two rings).
- Run a fax test.

When the phone rings, the printer answers automatically after the number of rings you set in the **Rings to Answer** setting. The printer begins emitting fax reception tones to the sending fax machine and receives the fax.

Case B: Set up the printer with DSL

If you have a DSL service through your telephone company, and do not connect any equipment to the printer, use the instructions in this section to connect a DSL filter between the telephone wall jack and the printer. The DSL filter removes the digital signal that can interfere with the printer, so the printer can communicate correctly with the phone line. (DSL might be called ADSL in your country/region.)

 **NOTE:** If you have a DSL line and you do not connect the DSL filter, you cannot send and receive faxes with the printer.

Back view of the printer

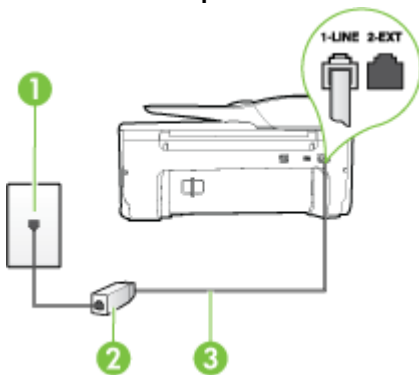

1	Telephone wall jack
2	DSL (or ADSL) filter and cord supplied by your DSL provider
3	Use the phone cord supplied in the box with the printer to connect to the 1-LINE port. You might need to connect the supplied phone cord to the adapter provided for your country/region.

To set up the printer with DSL

1. Obtain a DSL filter from your DSL provider.
2. Using the phone cord supplied in the box with the printer, connect one end to the open port on the DSL filter, and then connect the other end to the port labeled 1-LINE on the back of the printer.



NOTE: You might need to connect the supplied phone cord to the adapter provided for your country/region.

If you do not use the supplied cord to connect from the DSL filter to the printer, you might not be able to fax successfully. This special phone cord is different from the phone cords you might already have in your home or office.

As only one phone cord is supplied, you might need to obtain additional phone cords for this setup.

3. Connect an additional phone cord from the DSL filter to the telephone wall jack.
4. Run a fax test.

If you encounter problems setting up the printer with optional equipment, contact your local service provider or vendor for further assistance.

Case C: Set up the printer with a PBX phone system or an ISDN line

If you are using either a PBX phone system or an ISDN converter/terminal adaptor, make sure you do the following:

- If you are using either a PBX or an ISDN converter/terminal adaptor, connect the printer to the port that is designated for fax and phone use. Also, make sure that the terminal adaptor is set to the correct switch type for your country/region, if possible.



NOTE: Some ISDN systems allow you to configure the ports for specific phone equipment. For example, you might have assigned one port for telephone and Group 3 fax and another port for multiple purposes. If you have problems when connected to the fax/phone port of your ISDN converter, try using the port designated for multiple purposes; it might be labeled "multi-combi" or something similar.

- If you are using a PBX phone system, set the call waiting tone to "off."



NOTE: Many digital PBX systems include a call-waiting tone that is set to "on" by default. The call waiting tone interferes with any fax transmission, and you cannot send or receive faxes with the printer. Refer to the documentation that came with your PBX phone system for instructions on how to turn off the call-waiting tone.

- If you are using a PBX phone system, dial the number for an outside line before dialing the fax number.
- Make sure you use the supplied cord to connect from the telephone wall jack to the printer. If you do not, you might not be able to fax successfully. This special phone cord is different from the phone cords you might already have in your home or office. If the supplied phone cord is too short, you can purchase a coupler from your local electronics store and extend it. You might need to connect the supplied phone cord to the adapter provided for your country/region.

If you encounter problems setting up the printer with optional equipment, contact your local service provider or vendor for further assistance.

Case D: Fax with a distinctive ring service on the same line

If you subscribe to a distinctive ring service (through your telephone company) that allows you to have multiple phone numbers on one phone line, each with a different ring pattern, set up the printer as described in this section.

Back view of the printer

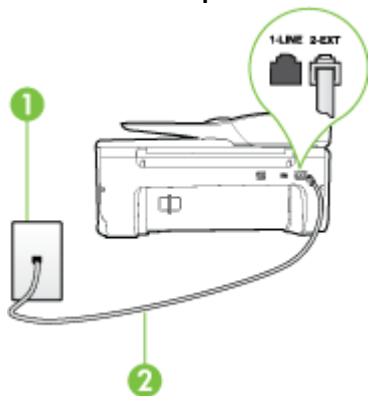

1	Telephone wall jack
2	Use the phone cord supplied in the box with the printer to connect to the 1-LINE port. You might need to connect the supplied phone cord to the adapter provided for your country/region.

To set up the printer with a distinctive ring service

- Using the phone cord supplied in the box with the printer, connect one end to your telephone wall jack, then connect the other end to the port labeled 1-LINE on the back of the printer.

 **NOTE:** You might need to connect the supplied phone cord to the adapter provided for your country/region.

If you do not use the supplied cord to connect from the telephone wall jack to the printer, you might not be able to fax successfully. This special phone cord is different from the phone cords you might already have in your home or office.

- Turn on the **Auto Answer** setting.
- Change the **Distinctive Ring** setting to match the pattern that the telephone company assigned to your fax number.

 **NOTE:** By default, the printer is set to answer all ring patterns. If you do not set the **Distinctive Ring** to match the ring pattern assigned to your fax number, the printer might answer both voice calls and fax calls or it might not answer at all.

 **TIP:** You can also use the Ring Pattern Detection feature in the printer's control panel to set distinctive ring. With this feature, the printer recognizes and records the ring pattern of an incoming call and, based on this call, automatically determines the distinctive ring pattern assigned by your telephone company to fax calls. For more information, see [Change the answer ring pattern for distinctive ring](#).

4. (Optional) Change the **Rings to Answer** setting to the lowest setting (two rings).
5. Run a fax test.

The printer automatically answers incoming calls that have the ring pattern you selected (**Distinctive Ring** setting) after the number of rings you selected (**Rings to Answer** setting). The printer begins emitting fax reception tones to the sending fax machine and receives the fax.

If you encounter problems setting up the printer with optional equipment, contact your local service provider or vendor for further assistance.

Case E: Shared voice/fax line

If you receive both voice calls and fax calls at the same phone number, and you have no other office equipment (or voice mail) on this phone line, set up the printer as described in this section.

Back view of the printer

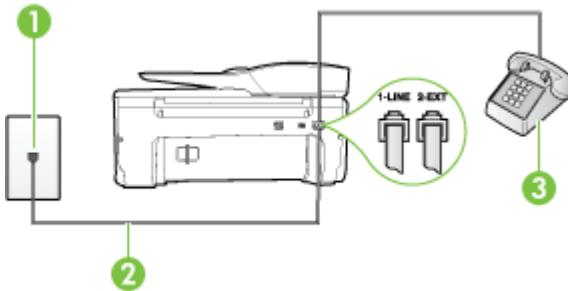

1	Telephone wall jack
2	Use the phone cord supplied in the box with the printer to connect to the 1-LINE port. You might need to connect the supplied phone cord to the adapter provided for your country/region.
3	Telephone (optional)

To set up the printer with a shared voice/fax line

1. Using the phone cord supplied in the box with the printer, connect one end to your telephone wall jack, then connect the other end to the port labeled 1-LINE on the back of the printer.

 **NOTE:** You might need to connect the supplied phone cord to the adapter provided for your country/region.

If you do not use the supplied cord to connect from the telephone wall jack to the printer, you might not be able to fax successfully. This special phone cord is different from the phone cords you might already have in your home or office.

2. Do one of the following:
 - If you have a parallel-type phone system, remove the white plug from the port labeled 2-EXT on the back of the printer, and then connect a phone to this port.
 - If you have a serial-type phone system, you might plug your phone directly on top of the printer cable which has a wall plug attached to it.

3. Now you need to decide how you want the printer to answer calls, automatically or manually:
 - If you set up the printer to answer calls **automatically**, it answers all incoming calls and receives faxes. The printer cannot distinguish between fax and voice calls in this case; if you suspect the call is a voice call, you need to answer it before the printer answers the call. To set up the printer to answer calls automatically, turn on the **Auto Answer** setting.
 - If you set up the printer to answer faxes **manually**, you must be available to respond in person to incoming fax calls or the printer cannot receive faxes. To set up the printer to answer calls manually, turn off the **Auto Answer** setting.
4. Run a fax test.

If you pick up the phone before the printer answers the call and hear fax tones from a sending fax machine, you need to answer the fax call manually.

If you encounter problems setting up the printer with optional equipment, contact your local service provider or vendor for further assistance.

Case F: Shared voice/fax line with voice mail

If you receive both voice calls and fax calls at the same phone number, and you also subscribe to a voice mail service through your telephone company, set up the printer as described in this section.

 **NOTE:** You cannot receive faxes automatically if you have a voice mail service at the same phone number you use for fax calls. You must receive faxes manually; this means you must be available to respond in person to incoming fax calls. If you want to receive faxes automatically instead, contact your telephone company to subscribe to a distinctive ring service, or to obtain a separate phone line for faxing.

Back view of the printer

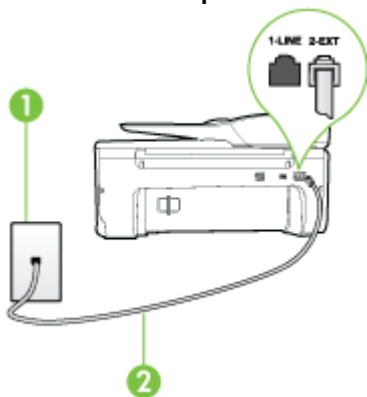

1	Telephone wall jack
2	Use the phone cord supplied in the box with the printer to connect to the 1-LINE port. You might need to connect the supplied phone cord to the adapter provided for your country/region.

To set up the printer with voice mail

1. Using the phone cord supplied in the box with the printer, connect one end to your telephone wall jack, then connect the other end to the port labeled 1-LINE on the back of the printer.

You might need to connect the supplied phone cord to the adapter provided for your country/region.

 **NOTE:** You might need to connect the supplied phone cord to the adapter provided for your country/region.

If you do not use the supplied cord to connect from the telephone wall jack to the printer, you might not be able to fax successfully. This special phone cord is different from the phone cords you might already have in your home or office.

2. Turn off the **Auto Answer** setting.
3. Run a fax test.

You must be available to respond in person to incoming fax calls, or the printer cannot receive faxes. You must initiate the manual fax before voicemail picks up the line.

If you encounter problems setting up the printer with optional equipment, contact your local service provider or vendor for further assistance.

Case G: Fax line shared with computer modem (no voice calls received)

If you have a fax line on which you receive no voice calls, and you also have a computer modem connected on this line, set up the printer as described in this section.

 **NOTE:** If you have a computer dial-up modem, your computer dial-up modem shares the phone line with the printer. You cannot use both your modem and the printer simultaneously. For example, you cannot use the printer for faxing while you are using your computer dial-up modem to send an email or access the Internet.

- [Set up the printer with a computer dial-up modem](#)
- [Set up the printer with a computer DSL/ADSL modem](#)

Set up the printer with a computer dial-up modem

If you are using the same phone line for sending faxes and for a computer dial-up modem, follow these directions for setting up the printer.

Back view of the printer

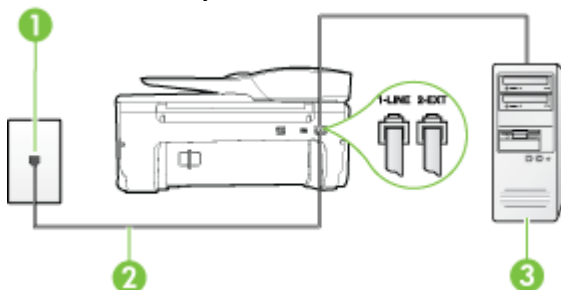

1	Telephone wall jack
2	Use the phone cord supplied in the box with the printer to connect to the 1-LINE port.

(continued)

	You might need to connect the supplied phone cord to the adapter provided for your country/region.
3	Computer with modem

To set up the printer with a computer dial-up modem

1. Remove the white plug from the port labeled 2-EXT on the back of the printer.
2. Find the phone cord that connects from the back of your computer (your computer dial-up modem) to a telephone wall jack. Disconnect the cord from the telephone wall jack and plug it into the port labeled 2-EXT on the back of the printer.
3. Using the phone cord supplied in the box with the printer, connect one end to your telephone wall jack, then connect the other end to the port labeled 1-LINE on the back of the printer.

 **NOTE:** You might need to connect the supplied phone cord to the adapter provided for your country/region.

If you do not use the supplied cord to connect from the telephone wall jack to the printer, you might not be able to fax successfully. This special phone cord is different from the phone cords you might already have in your home or office.

4. If your modem software is set to receive faxes to your computer automatically, turn off that setting.

 **NOTE:** If you do not turn off the automatic fax reception setting in your modem software, the printer cannot receive faxes.

5. Turn on the **Auto Answer** setting.
6. (Optional) Change the **Rings to Answer** setting to the lowest setting (two rings).
7. Run a fax test.

When the phone rings, the printer automatically answers after the number of rings you set in the **Rings to Answer** setting. The printer begins emitting fax reception tones to the sending fax machine and receives the fax.

If you encounter problems setting up the printer with optional equipment, contact your local service provider or vendor for further assistance.

Set up the printer with a computer DSL/ADSL modem

If you have a DSL line and use that phone line to send faxes, follow these instructions to set up your fax.

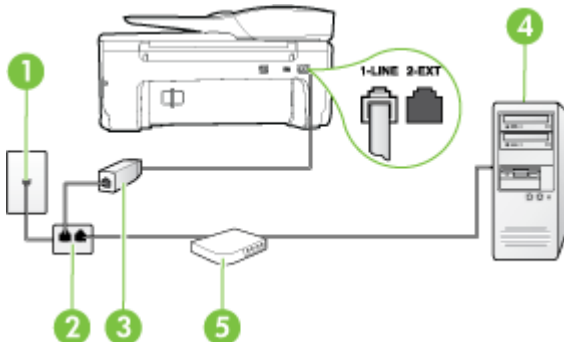

1	Telephone wall jack
2	Parallel splitter
3	DSL/ADSL filter Connect one end of the phone jack that was supplied with the printer to connect to the 1-LINE port on the back of the printer. Connect the other end of the cord to the DSL/ADSL filter. You might need to connect the supplied phone cord to the adapter provided for your country/region.
4	Computer
5	Computer DSL/ADSL modem

 **NOTE:** You need to purchase a parallel splitter. A parallel splitter has one RJ-11 port on the front and two RJ-11 ports on the back. Do not use a 2-line phone splitter, a serial splitter, or a parallel splitter which has two RJ-11 ports on the front and a plug on the back.



To set up the printer with a computer DSL/ADSL modem

1. Obtain a DSL filter from your DSL provider.
2. Using the phone cord provided in the box with the printer, connect one end to the DSL filter, and then connect the other end to the port labeled 1-LINE on the back of the printer.

 **NOTE:** You might need to connect the supplied phone cord to the adapter provided for your country/region.

If you do not use the supplied cord to connect from the DSL filter to the back of the printer, you might not be able to fax successfully. This special phone cord is different from the phone cords you might already have in your home or office.

3. Connect the DSL filter to the parallel splitter.
4. Connect the DSL modem to the parallel splitter.
5. Connect the parallel splitter to the wall jack.
6. Run a fax test.

When the phone rings, the printer automatically answers after the number of rings you set in the **Rings to Answer** setting. The printer begins emitting fax reception tones to the sending fax machine and receives the fax.

If you encounter problems setting up the printer with optional equipment, contact your local service provider or vendor for further assistance.

Case H: Shared voice/fax line with computer modem

There are two different ways to set up the printer with your computer based on the number of phone ports on your computer. Before you begin, check your computer to see if it has one or two phone ports.

NOTE: If your computer has only one phone port, you need to purchase a parallel splitter (also called a coupler), as shown in the illustration. (A parallel splitter has one RJ-11 port on the front and two RJ-11 ports on the back. Do not use a two-line phone splitter, a serial splitter, or a parallel splitter which has two RJ-11 ports on the front and a plug on the back.)

- [Shared voice/fax with computer dial-up modem](#)
- [Shared voice/fax with computer DSL/ADSL modem](#)

Shared voice/fax with computer dial-up modem

If you use your phone line for both fax and telephone calls, use these instructions to set up your fax.

There are two different ways to set up the printer with your computer based on the number of phone ports on your computer. Before you begin, check your computer to see if it has one or two phone ports.

NOTE: If your computer has only one phone port, you need to purchase a parallel splitter (also called a coupler), as shown in the illustration. (A parallel splitter has one RJ-11 port on the front and two RJ-11 ports on the back. Do not use a two-line phone splitter, a serial splitter, or a parallel splitter which has two RJ-11 ports on the front and a plug on the back.)

Example of a parallel splitter



To set up the printer on the same phone line as a computer with two phone ports

Back view of the printer

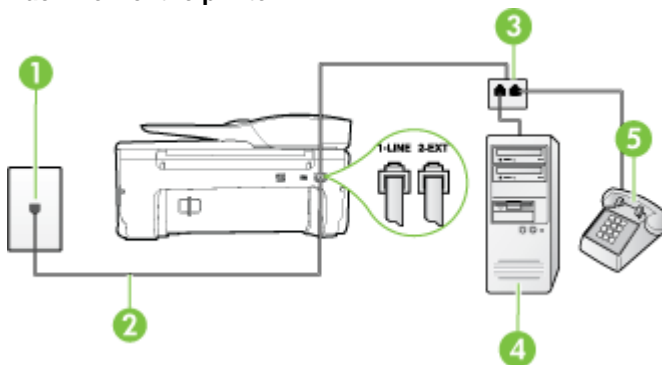

1	Telephone wall jack
2	Use the phone cord supplied in the box with the printer to connect to the 1-LINE port.
3	Parallel splitter
4	Computer with modem
5	Telephone

1. Remove the white plug from the port labeled 2-EXT on the back of the printer.
2. Find the phone cord that connects from the back of your computer (your computer dial-up modem) to a telephone wall jack. Disconnect the cord from the telephone wall jack and plug it into the port labeled 2-EXT on the back of the printer.
3. Connect a phone to the "OUT" port on the back of your computer dial-up modem.
4. Using the phone cord supplied in the box with the printer, connect one end to your telephone wall jack, then connect the other end to the port labeled 1-LINE on the back of the printer.

 **NOTE:** You might need to connect the supplied phone cord to the adapter provided for your country/region.

If you do not use the supplied cord to connect from the telephone wall jack to the printer, you might not be able to fax successfully. This special phone cord is different from the phone cords you might already have in your home or office.

5. If your modem software is set to receive faxes to your computer automatically, turn off that setting.

 **NOTE:** If you do not turn off the automatic fax reception setting in your modem software, the printer cannot receive faxes.

6. Now you need to decide how you want the printer to answer calls, automatically or manually:

- If you set up the printer to answer calls **automatically**, it answers all incoming calls and receives faxes. The printer cannot distinguish between fax and voice calls in this case; if you suspect the call is a voice call, you need to answer it before the printer answers the call. To set up the printer to answer calls automatically, turn on the **Auto Answer** setting.
- If you set up the printer to answer faxes **manually**, you must be available to respond in person to incoming fax calls or the printer cannot receive faxes. To set up the printer to answer calls manually, turn off the **Auto Answer** setting.

7. Run a fax test.

If you pick up the phone before the printer answers the call and hear fax tones from a sending fax machine, you need to answer the fax call manually.

If you use your phone line for voice, fax, and your computer dial-up modem, follow these directions to set up your fax.

If you encounter problems setting up the printer with optional equipment, contact your local service provider or vendor for further assistance.

Shared voice/fax with computer DSL/ADSL modem

Use these instructions if your computer has a DSL/ADSL modem

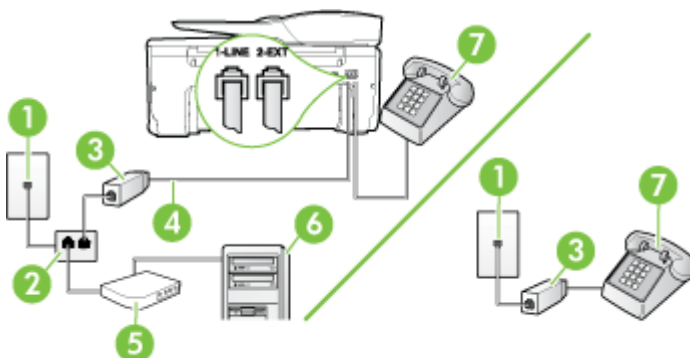

1	Telephone wall jack
2	Parallel splitter
3	DSL/ADSL filter
4	Use the phone cord provided to connect to the 1-LINE port on the back of the printer. You might need to connect the supplied phone cord to the adapter provided for your country/region.
5	DSL/ADSL modem
6	Computer
7	Telephone

NOTE: You need to purchase a parallel splitter. A parallel splitter has one RJ-11 port on the front and two RJ-11 ports on the back. Do not use a 2-line phone splitter, a serial splitter, or a parallel splitter which has two RJ-11 ports on the front and a plug on the back.



To set up the printer with a computer DSL/ADSL modem

1. Obtain a DSL filter from your DSL provider.

 **NOTE:** Phones in other parts of the home/office sharing the same phone number with DSL service need to be connected to additional DSL filters to avoid noise when making voice calls.

2. Using the phone cord supplied in the box with the printers, connect one end to the DSL filter, then connect the other end to the port labeled 1-LINE on the back of the printer.

 **NOTE:** You might need to connect the supplied phone cord to the adapter provided for your country/region.

If you do not use the supplied cord to connect from the DSL filter to the printer, you might not be able to fax successfully. This special phone cord is different from phone cords you might already have in your home or office.

3. If you have a parallel-type phone system, remove the white plug from the port labeled 2-EXT on the back of the printer, and then connect a phone to this port.
4. Connect the DSL filter to the parallel splitter.
5. Connect the DSL modem to the parallel splitter.
6. Connect the parallel splitter to the wall jack.
7. Run a fax test.

When the phone rings, the printer automatically answers after the number of rings you set in the **Rings to Answer** setting. The printer begins emitting fax reception tones to the sending fax machine and receives the fax.

If you encounter problems setting up the printer with optional equipment, contact your local service provider or vendor for further assistance.

Case I: Shared voice/fax line with answering machine

If you receive both voice calls and fax calls at the same phone number, and you also have an answering machine that answers voice calls at this phone number, set up the printer as described in this section.

Back view of the printer

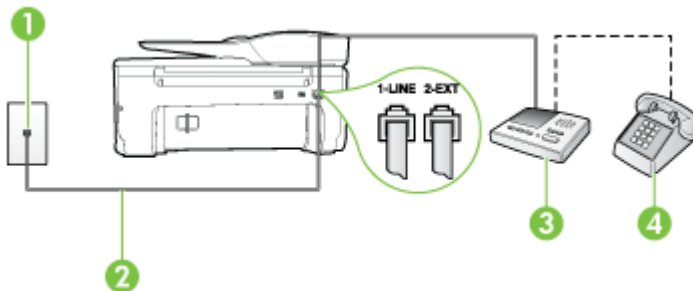

1	Telephone wall jack
2	Use the phone cord provided to connect to the 1-LINE port on the back of the printer You might need to connect the supplied phone cord to the adapter provided for your country/region.

(continued)

3	Answering machine
4	Telephone (optional)

To set up the printer with a shared voice/fax line with answering machine

1. Remove the white plug from the port labeled 2-EXT on the back of the printer.
2. Unplug your answering machine from the telephone wall jack, and connect it to the port labeled 2-EXT on the back of the printer.



NOTE: If you do not connect your answering machine directly to the printer, fax tones from a sending fax machine might be recorded on your answering machine, and you might not receive faxes with the printer.

3. Using the phone cord supplied in the box with the printer, connect one end to your telephone wall jack, then connect the other end to the port labeled 1-LINE on the back of the printer.



NOTE: You might need to connect the supplied phone cord to the adapter provided for your country/region.

If you do not use the supplied cord to connect from the telephone wall jack to the printer, you might not be able to fax successfully. This special phone cord is different from the phone cords you might already have in your home or office.

4. (Optional) If your answering machine does not have a built-in phone, for convenience you might want to connect a phone to the back of your answering machine at the "OUT" port.



NOTE: If your answering machine does not let you connect an external phone, you can purchase and use a parallel splitter (also known as a coupler) to connect both the answering machine and telephone to the printer. You can use standard phone cords for these connections.

5. Turn on the **Auto Answer** setting.
6. Set your answering machine to answer after a low number of rings.
7. Change the **Rings to Answer** setting on the printer to the maximum number of rings supported by your printer. (The maximum number of rings varies by country/region.)
8. Run a fax test.

When the phone rings, your answering machine answers after the number of rings you have set, and then plays your recorded greeting. The printer monitors the call during this time, "listening" for fax tones. If incoming fax tones are detected, the printer emits fax reception tones and receives the fax; if there are no fax tones, the printer stops monitoring the line and your answering machine can record a voice message.

If you encounter problems setting up the printer with optional equipment, contact your local service provider or vendor for further assistance.

Case J: Shared voice/fax line with computer modem and answering machine

If you receive both voice calls and fax calls at the same phone number, and you also have a computer modem and answering machine connected on this phone line, set up the printer as described in this section.

 **NOTE:** Since your computer dial-up modem shares the phone line with the printer, you cannot use both your modem and the printer simultaneously. For example, you cannot use the printer for faxing while you are using your computer dial-up modem to send an email or access the Internet.

- Shared voice/fax line with computer dial-up modem and answering machine
- Shared voice/fax line with computer DSL/ADSL modem and answering machine

Shared voice/fax line with computer dial-up modem and answering machine

There are two different ways to set up the printer with your computer based on the number of phone ports on your computer. Before you begin, check your computer to see if it has one or two phone ports.

 **NOTE:** If your computer has only one phone port, you need to purchase a parallel splitter (also called a coupler), as shown in the illustration. (A parallel splitter has one RJ-11 port on the front and two RJ-11 ports on the back. Do not use a two-line phone splitter, a serial splitter, or a parallel splitter which has two RJ-11 ports on the front and a plug on the back.)

Example of a parallel splitter



To set up the printer on the same phone line as a computer with two phone ports

Back view of the printer

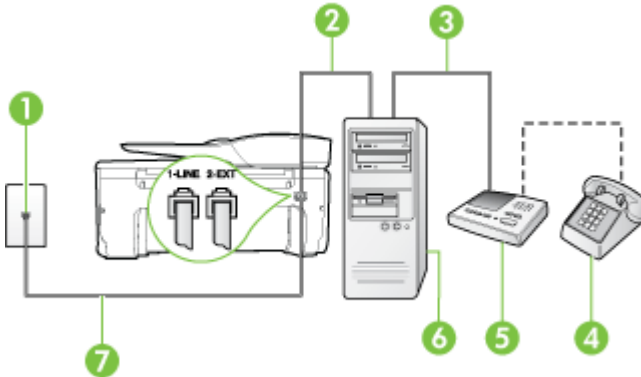

1	Telephone wall jack
2	"IN" phone port on your computer
3	"OUT" phone port on your computer
4	Telephone (optional)
5	Answering machine
6	Computer with modem

(continued)

7	<p>Use the phone cord supplied in the box with the printer to connect to the 1-LINE port.</p> <p>You might need to connect the supplied phone cord to the adapter provided for your country/region.</p>
---	---

1. Remove the white plug from the port labeled 2-EXT on the back of the printer.
2. Find the phone cord that connects from the back of your computer (your computer dial-up modem) to a telephone wall jack. Disconnect the cord from the telephone wall jack and plug it into the port labeled 2-EXT on the back of the printer.
3. Unplug your answering machine from the telephone wall jack, and connect it to the port labeled "OUT" on the back of the computer (the computer dial-up modem).
4. Using the phone cord supplied in the box with the printer, connect one end to your telephone wall jack, then connect the other end to the port labeled 1-LINE on the back of the printer.



NOTE: You might need to connect the supplied phone cord to the adapter provided for your country/region.

If you do not use the supplied cord to connect from the telephone wall jack to the printer, you might not be able to fax successfully. This special phone cord is different from the phone cords you might already have in your home or office.

5. (Optional) If your answering machine does not have a built-in phone, for convenience you might want to connect a phone to the back of your answering machine at the "OUT" port.



NOTE: If your answering machine does not let you connect an external phone, you can purchase and use a parallel splitter (also known as a coupler) to connect both the answering machine and telephone to the printer. You can use standard phone cords for these connections.

6. If your modem software is set to receive faxes to your computer automatically, turn off that setting.



NOTE: If you do not turn off the automatic fax reception setting in your modem software, the printer cannot receive faxes.

7. Turn on the **Auto Answer** setting.
8. Set your answering machine to answer after a low number of rings.
9. Change the **Rings to Answer** setting on the printer to the maximum number of rings supported by the product. (The maximum number of rings varies by country/region.)
10. Run a fax test.

When the phone rings, your answering machine answers after the number of rings you have set, and then plays your recorded greeting. The printer monitors the call during this time, "listening" for fax tones. If incoming fax tones are detected, the printer emits fax reception tones and receives the fax; if there are no fax tones, the printer stops monitoring the line and your answering machine can record a voice message.

If you encounter problems setting up the printer with optional equipment, contact your local service provider or vendor for further assistance.

Shared voice/fax line with computer DSL/ADSL modem and answering machine

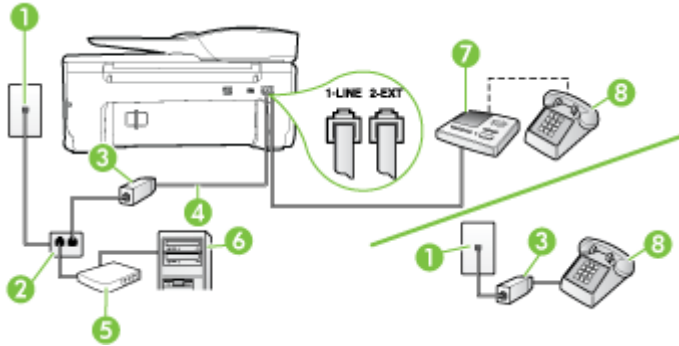

1	Telephone wall jack
2	Parallel splitter
3	DSL/ADSL filter
4	Phone cord provided with the printer connected to the 1-LINE port on the back of the printer You might need to connect the supplied phone cord to the adapter provided for your country/region.
5	DSL/ADSL modem
6	Computer
7	Answering machine
8	Telephone (optional)

 **NOTE:** You need to purchase a parallel splitter. A parallel splitter has one RJ-11 port on the front and two RJ-11 ports on the back. Do not use a 2-line phone splitter, a serial splitter, or a parallel splitter which has two RJ-11 ports on the front and a plug on the back.



To set up the printer with a computer DSL/ADSL modem

1. Obtain a DSL/ADSL filter from your DSL/ADSL provider.

 **NOTE:** Phones in other parts of the home/office sharing the same phone number with DSL/ADSL service need to be connected to additional DSL/ADSL filters, to avoid noise when making voice calls.

2. Using the phone cord supplied in the box with the printer, connect one end to the DSL/ADSL filter, then connect the other end to the port labeled 1-LINE on the back of the printer.

 **NOTE:** You might need to connect the supplied phone cord to the adapter provided for your country/region.

If you do not use the supplied cord to connect from the DSL/ADSL filter to the printer, you might not be able to fax successfully. This special phone cord is different from the phone cords you might already have in your home or office.

3. Connect the DSL/ADSL filter to the splitter.
4. Unplug the answering machine from the telephone wall jack, and connect it to the port labeled 2-EXT on the back of the printer.

 **NOTE:** If you do not connect your answering machine directly to the printer, fax tones from a sending fax machine might be recorded on your answering machine, and you might not receive faxes with the printer.

5. Connect the DSL modem to the parallel splitter.
6. Connect the parallel splitter to the wall jack.
7. Set your answering machine to answer after a low number of rings.
8. Change your **Rings to Answer** setting on the printer to the maximum number of rings supported by the printer.

 **NOTE:** The maximum number of rings varies by country/region.

9. Run a fax test.

When the phone rings, your answering machine answers after the number of rings you have set, and then play your recorded greeting. The printer monitors the call during this time, "listening" for fax tones. If incoming fax tones are detected, the printer emits fax reception tones and receive the fax; if there are no fax tones, the printer stops monitoring the line and your answering machine can record a voice message.

If you use the same phone line for telephone, fax, and have a computer DSL modem, follow these instructions to set up your fax.

If you encounter problems setting up the printer with optional equipment, contact your local service provider or vendor for further assistance.

Case K: Shared voice/fax line with computer dial-up modem and voice mail

If you receive both voice calls and fax calls at the same phone number, use a computer dial-up modem on the same phone line, and subscribe to a voice mail service through your telephone company, set up the printer as described in this section.

 **NOTE:** You cannot receive faxes automatically if you have a voice mail service at the same phone number you use for fax calls. You must receive faxes manually; this means you must be available to respond in person to incoming fax calls. If you want to receive faxes automatically instead, contact your telephone company to subscribe to a distinctive ring service, or to obtain a separate phone line for faxing.

Since your computer dial-up modem shares the phone line with the printer, you cannot use both your modem and the printer simultaneously. For example, you cannot use the printer for faxing if you are using your computer dial-up modem to send an email or access the Internet.

There are two different ways to set up the printer with your computer based on the number of phone ports on your computer. Before you begin, check your computer to see if it has one or two phone ports.

- If your computer has only one phone port, you need to purchase a parallel splitter (also called a coupler), as shown in the illustration. (A parallel splitter has one RJ-11 port on the front and two RJ-11 ports on the back. Do not use a two-line phone splitter, a serial splitter, or a parallel splitter which has two RJ-11 ports on the front and a plug on the back.)

Example of a parallel splitter



- If your computer has two phone ports, set up the printer as follows:

Back view of the printer

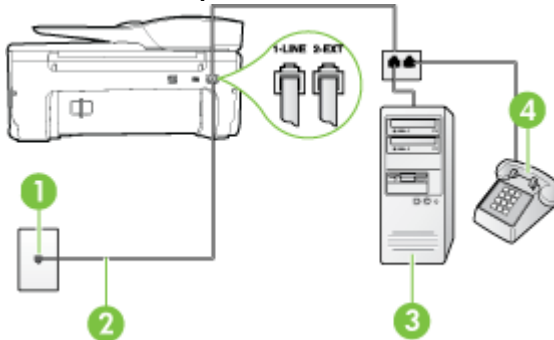

1	Telephone wall jack
2	Use the phone cord supplied in the box with the printer to connect to the 1-LINE port You might need to connect the supplied phone cord to the adapter provided for your country/region.
3	Computer with modem
4	Telephone

To set up the printer on the same phone line as a computer with two phone ports

1. Remove the white plug from the port labeled 2-EXT on the back of the printer.
2. Find the phone cord that connects from the back of your computer (your computer dial-up modem) to a telephone wall jack. Disconnect the cord from the telephone wall jack and plug it into the port labeled 2-EXT on the back of the printer.
3. Connect a phone to the "OUT" port on the back of your computer dial-up modem.

4. Using the phone cord supplied in the box with the printer, connect one end to your telephone wall jack, then connect the other end to the port labeled 1-LINE on the back of the printer.

 **NOTE:** You might need to connect the supplied phone cord to the adapter provided for your country/region.

If you do not use the supplied cord to connect from the telephone wall jack to the printer, you might not be able to fax successfully. This special phone cord is different from the phone cords you might already have in your home or office.

5. If your modem software is set to receive faxes to your computer automatically, turn off that setting.

 **NOTE:** If you do not turn off the automatic fax reception setting in your modem software, the printer cannot receive faxes.

6. Turn off the **Auto Answer** setting.

7. Run a fax test.

You must be available to respond in person to incoming fax calls, or the printer cannot receive faxes.

If you encounter problems setting up the printer with optional equipment, contact your local service provider or vendor for further assistance.

Serial-type fax setup

For information on setting up the printer for faxing using a serial-type phone system, see the Fax Configuration web site for your country/region.

Austria	www.hp.com/at/faxconfig
Germany	www.hp.com/de/faxconfig
Switzerland (French)	www.hp.com/ch/fr/faxconfig
Switzerland (German)	www.hp.com/ch/de/faxconfig
United Kingdom	www.hp.com/uk/faxconfig
Finland	www.hp.fi/faxconfig
Denmark	www.hp.dk/faxconfig
Sweden	www.hp.se/faxconfig
Norway	www.hp.no/faxconfig
Netherlands	www.hp.nl/faxconfig
Belgium (Dutch)	www.hp.be/nl/faxconfig
Belgium (French)	www.hp.be/fr/faxconfig
Portugal	www.hp.pt/faxconfig
Spain	www.hp.es/faxconfig
France	www.hp.com/fr/faxconfig
Ireland	www.hp.com/ie/faxconfig

Test fax setup

You can test your fax setup to check the status of the printer and to make sure it is set up correctly for faxing. Perform this test after you have completed setting up the printer for faxing. The test does the following:

- Tests the fax hardware
- Verifies the correct type of phone cord is connected to the printer
- Checks that the phone cord is plugged into the correct port
- Checks for a dial tone
- Checks for an active phone line
- Tests the status of your phone line connection

The printer prints a report with the results of the test. If the test fails, review the report for information on how to fix the problem and rerun the test.

To test fax setup via the printer control panel

1. Set up the printer for faxing according to your particular home or office setup instructions.
2. Make sure the ink cartridges are installed, and that full-size paper is loaded in the input tray before starting the test.
3. From the printer control panel, touch  (right arrow), and then touch **Setup**.
4. Touch **Tools**, and then touch **Run Fax Test**.
The printer displays the status of the test on the display and prints a report.
5. Review the report.
 - If the test passes and you are still having problems faxing, check the fax settings listed in the report to verify the settings are correct. A blank or incorrect fax setting can cause problems faxing.
 - If the test fails, review the report for more information on how to fix any problems found.

D Network setup

You can manage network settings for the printer through the printer control panel as described in the next section. Additional advanced settings are available in the embedded web server, a configuration and status tool you access from your web browser using an existing network connection to the printer. For more information, see [Embedded web server](#).

This section contains the following topics:

- [Set up the printer for wireless communication](#)
- [Change basic network settings](#)
- [Change advanced network settings](#)
- [Uninstall and reinstall the HP software](#)

Set up the printer for wireless communication

You can set up the printer for wireless communication.

This section contains the following topics:

- [Before you begin](#)
- [Set up the printer on your wireless network](#)
- [Set up the printer using the HP printer software \(Recommended\)](#)
- [Set up the printer using the Wireless Setup Wizard](#)
- [Set up the printer using WiFi Protected Setup \(WPS\)](#)
- [Set up the printer using the embedded web server \(EWS\)](#)
- [Change the connection type](#)
- [Test the wireless connection](#)
- [Guidelines for ensuring wireless network security](#)
- [Guidelines for reducing interference on a wireless network](#)



NOTE: If you encounter problems connecting the printer, see [Solve wireless problems](#)



TIP: For more information about setting up and using the printer wirelessly, visit the HP Wireless Printing Center (www.hp.com/go/wirelessprinting).

Before you begin

Before you begin setting up the wireless connection, check the following:

- The wireless network is set up and functioning correctly.
- The printer and the computers that use the printer are on the same network (subnet).

While connecting the printer, you might be prompted to enter the wireless network name (SSID) and a wireless password:

- The wireless network name is the name of your wireless network.
- The wireless password prevents other people from connecting to your wireless network without your permission. Depending on the level of security required, your wireless network might use either a WPA key or WEP passphrase.

If you have not changed the network name or the security passkey since setting up your wireless network, you can sometimes find them on the back or side of the wireless router.

If you cannot find the network name or the security passkey or cannot remember this information, see the documentation available with your computer or with the wireless router. If you still cannot find this information, contact your network administrator or the person who set up the wireless network.

 **TIP:** If you are using a computer running Windows, HP provides a tool called HP Home Network Diagnostic Utility that can help retrieve this information for some systems. To use this tool, visit the HP Wireless Printing Center (www.hp.com/go/wirelessprinting), and then click **Network Diagnostic Utility** in the **Quick Links** section. (At this time, this tool might not be available in all languages.)

Set up the printer on your wireless network

To set up the printer on your wireless network, use one of the following methods:

- Set up the printer using the Wireless Setup Wizard (Recommended)
- Set up the printer using the HP printer software (Recommended)
- Set up the printer using WiFi Protected Setup (WPS)
- Set up the printer using the embedded web server (EWS)

 **NOTE:** If you have already been using the printer with a different type of connection, such as a USB connection, follow the instructions in [Change the connection type](#) to set up the printer on your wireless network.

Set up the printer using the HP printer software (Recommended)

In addition to enabling key printer features, you can use the HP printer software that came with your printer to set up wireless communication.

If you have already been using the printer with a different type of connection, such as a USB connection, follow the instructions in [Change the connection type](#) to set up the printer on your wireless network.

Set up the printer using the Wireless Setup Wizard

The Wireless Setup Wizard provides an easy way to set up and manage a wireless connection to your printer from the printer control panel.

1. Set up the printer hardware. See the getting started guide or the setup poster that came with your printer.
2. On the printer control panel, touch  (right arrow), touch **Setup**, and then touch **Network**.
3. Touch **Wireless Setup Wizard**, and then touch **OK**.
4. Follow the display instructions to complete the setup.

 **NOTE:** If you cannot find the wireless network name (SSID) and wireless password (WPA passphrase, WEP key), see [Before you begin](#).

Set up the printer using WiFi Protected Setup (WPS)

Wi-Fi Protected Setup (WPS) allows you to quickly set up the printer on your wireless network, without having to enter the wireless network name (SSID), wireless password (WPA passphrase, WEP key), or other wireless settings.

 **NOTE:** Only set up wireless using WPS if your wireless network uses WPA data encryption. If your wireless network uses WEP or is not using any encryption at all, use one of the other methods provided in this section to set up the printer on your wireless network.

NOTE: To use WPS, make sure your wireless router or wireless access point supports

WPS. Routers that support WPS often have a  (WPS) button or a button labeled "WPS".

You can use one of the following methods to set up the printer using WPS:

- Push Button Method: Use the  (WPS) or WPS button, if available, on your router.
- PIN Method: Enter the PIN generated by the printer in the router's configuration software.

To connect the printer using the Push Button Method

1. On the printer control panel, touch , touch **Setup**, and then touch **Network**.
2. Touch **Wi-Fi Protected Setup**, and then follow the onscreen instructions.
3. When prompted, touch **Push Button**.
4. On the wireless router or wireless access point, press and hold the WPS button for 3 seconds. Wait for about 2 minutes. If the printer connects successfully, the wireless light stops blinking but remains lit.

To connect the printer using the PIN Method

1. On the printer control panel, touch , touch **Setup**, and then touch **Network**.
2. Touch **Wi-Fi Protected Setup**, and then follow the onscreen instructions.
3. When prompted, touch **PIN**. The WPS PIN appears on the display.
4. Open the configuration utility or software for the wireless router or wireless access point, and then enter the WPS PIN.



NOTE: For more information about using the configuration utility, see the documentation provided with the router or wireless access point.

Wait for about two minutes. If the printer connects successfully, the wireless light stops blinking but remains lit.

Set up the printer using the embedded web server (EWS)

If the printer is connected to a network, you can use the printer's embedded web server (EWS) to set up wireless communication.

1. Open the EWS. For more information, see [To open the embedded web server](#).
2. On the **Home** tab, click **Wireless Setup Wizard** in the **Setup** box.
3. Follow the onscreen instructions.



TIP: You can also set up wireless communication by entering or changing individual wireless settings. To change these settings, on the **Network** tab, click **Advanced** in the Wireless (802.11) section on the left, change the wireless settings, and then click **Apply**.

Change the connection type

After you have installed the HP software and connected the printer to your computer or to a network, you can use the HP software to change the connection type (for example, from a USB connection to a wireless connection).



NOTE: You might be prompted to temporarily connect a USB cable during the setup process.

To change from a USB connection to a wireless connection

Follow the instructions for your operating system.

Windows

1. On the computer desktop, click **Start**, select **Programs** or **All Programs**, click **HP**, select your printer name, and then click **Printer Setup & Software**.
2. Click **Connect a new printer**, and then click **Convert a USB connected printer to wireless**.
3. Follow the display instructions to complete the setup.

Mac OS X

1. Open HP Utility. For more information, see [To open HP Utility](#).
2. Click the **Applications** on the HP Utility toolbar.
3. Double-click **HP Setup Assistant**, and then follow the onscreen instructions.

To change from a wireless connection to a USB connection

To change from a wireless connection to a USB connection, connect the USB cable to the printer.

 **NOTE:** If you are using a computer with Mac OS X, add the printer to the print queue. Click **System Preferences** in the Dock, click **Print & Fax** or **Print & Scan** in the **Hardware** section, click **+**, and then select the printer.

Test the wireless connection

Print the wireless test page for information about the printer's wireless connection. The wireless test page provides information about the printer's status, hardware (MAC) address, and IP address. If the printer is connected to a network, the test page displays details about the network settings.

To print the wireless test page

1. On the printer control panel, touch  (right arrow), touch **Setup**, and then touch **Network**.
2. Touch **Print Wireless Network Test**.

Guidelines for ensuring wireless network security

The following information can help you keep your wireless network and wireless printer secure from unauthorized use.

For more information, visit www.hp.com/go/wirelessprinting.

This section contains the following topics:

- [Overview of security settings](#)
- [Add hardware addresses to a wireless router \(MAC filtering\)](#)
- [Other wireless security guidelines](#)

Overview of security settings

To help improve the security of the wireless network and prevent unauthorized access, the printer supports many common types of network authentication, including WEP, WPA, and WPA2.

- **WEP:** Provides security by encrypting data sent over radio waves from one wireless device to another wireless device. Devices on a WEP-enabled network use WEP keys to encode data. If your network uses WEP, you must know the WEP key(s) it uses.
- **WPA:** Increases the level of over-the-air data protection and access control on existing and future wireless networks. It addresses all known weaknesses of WEP, the original native security mechanism in the 802.11 standard. WPA uses the Temporal Key Integrity Protocol (TKIP) for encryption and employs 802.1X authentication with one of the standard Extensible Authentication Protocol (EAP) types available today.
- **WPA2:** Provides enterprise and consumer wireless users with a high level of assurance that only authorized users can access their wireless networks. WPA2 provides the Advanced Encryption Standard (AES). AES is defined in counter cipher-block chaining mode (CCM) and supports the Independent Basic Service Set (IBSS) to enable security between client workstations operating connected wirelessly without a wireless router (such as a Linksys wireless router or Apple AirPort Base Station).

Add hardware addresses to a wireless router (MAC filtering)

MAC filtering is a security feature in which a wireless router or wireless access point is configured with a list of hardware addresses (also called "MAC addresses") of devices that are allowed to gain access to the network through the router.

If the router filters hardware addresses, then the printer's hardware address must be added to the router's list of accepted hardware addresses. If the router does not have the hardware address of a printer attempting to access the network, the router denies the printer access to the network.

 **CAUTION:** This method is not recommended, however, because your MAC addresses can easily be read and falsified by unwanted users outside your network.

To add hardware addresses to a wireless router or wireless access point

1. Print the network configuration page, and then locate the printer's hardware address. For more information, see [Understand the network configuration page](#).



NOTE: The printer maintains a separate hardware address for the wireless connection. The hardware address is listed on the printer's network configuration page.

2. Open the configuration utility for the wireless router or wireless access point, and add the printer's hardware address to the list of accepted hardware addresses.



NOTE: For more information about using the configuration utility, see the documentation provided with the router or wireless access point.

Other wireless security guidelines

To keep the wireless network secure, follow these guidelines:

- Use a wireless password with at least 20 random characters. You can use up to 64 characters in a WPA wireless password.
- Avoid any common words or phrases, easy sequences of characters (such as all 1s), and personally-identifiable information for wireless passwords. Always use random strings composed of uppercase and lowercase letters, numbers, and if allowed, special characters such as punctuation.
- Change the default wireless password provided by the manufacturer for administrator access to the access point or wireless router. Some routers let you change the administrator name as well.
- Turn off administrative access over wireless if possible. If you do this, you need to connect to the router with a wired connection when you want to make configuration changes.
- Turn off remote administrative access over the Internet on your router, if possible. You can use Remote Desktop to make an encrypted connection to a computer running behind your router and make configuration changes from the local computer you are accessing over the Internet.
- To avoid accidentally connecting to another party's wireless network, turn off the setting to automatically connect to non-preferred networks. This is disabled by default in Windows XP.

Guidelines for reducing interference on a wireless network

The following tips will help reduce the chances for interference in a wireless network:

- Keep the wireless devices away from large metal objects, such as filing cabinets, and other electromagnetic devices, such as microwaves and cordless telephones, as these objects can disrupt radio signals.
- Keep the wireless devices away from large masonry structures and other building structures as these objects can absorb radio waves and lower signal strength.
- Position the access point or wireless router in a central location in line of sight with the wireless devices on the network.
- Keep all wireless devices on the network within range of one another.

Change basic network settings

The control panel options enable you to set up and manage a wireless connection and to perform a variety of network management tasks. This includes viewing the network settings, restoring the network defaults, turning the wireless radio on and off, and changing the network settings.

This section contains the following topics:

- [View and print network settings](#)
- [Turn the wireless radio on and off](#)

View and print network settings

You can display a summary of the network settings on the printer control panel or the HP software that came with the printer. You can print a more detailed network configuration page, which lists all of the important network settings such as the IP address, link speed, DNS, and mDNS. For more information, see [Understand the network configuration page](#).

Turn the wireless radio on and off

The wireless radio is on by default, as indicated by the blue light on the front of the printer. In order to stay connected to a wireless network, the radio must stay on. However, if you have a USB connection, the radio is not used. In this case you might want to turn the radio off.

1. Touch , touch **Setup**, and then touch **Network**.
2. Touch **Wireless**, and then touch **On** to turn on the radio, or **Off** to turn off the radio.

Change advanced network settings

⚠ CAUTION: Network settings are provided for your convenience. However, unless you are an advanced user, you should not change some of these settings (such as the link speed, IP settings, default gateway, and firewall settings).

This section contains the following topics:

- [Set link speed](#)
- [View IP settings](#)
- [Change IP settings](#)
- [Reset network settings](#)

Set link speed

You can change the speed at which data is transmitted over the network. The default is **Automatic**.

1. Touch , touch **Setup**, and then touch **Network**.
2. Select **Advanced Setup**, then touch **Link Speed**.
3. Touch the number next to the link speed that matches your network hardware.

View IP settings

To view the IP address of the printer:

- Print the network configuration page. For more information, see [Understand the network configuration page](#).
- Open the HP software (Windows), double-click **Estimated Ink Levels**, click the **Device Information** tab. The IP address is listed in the **Network Information** section.

Change IP settings

The default IP setting for the IP settings is **Automatic**, which sets the IP settings automatically. However, if you are an advanced user, you might want to manually change settings such as the IP address, subnet mask, or the default gateway.

⚠ CAUTION: Be careful when manually assigning an IP address. If you enter an invalid IP address during the installation, your network components cannot connect with the printer.

1. Touch , touch **Setup**, and then touch **Network**.
2. Touch **Advanced Setup**, and then touch **IP Settings**.
3. A message appears warning that changing the IP address removes the printer from the network. Touch **OK** to continue.

4. **Automatic** is selected by default. To change the settings manually, touch **Manual**, and then enter the appropriate information for the following settings:
 - **IP Address**
 - **Subnet Mask**
 - **Default Gateway**
 - **DNS Address**
5. Enter your changes, and then touch **Done**.

Reset network settings

To reset the administrator password and network settings

1. On the printer control panel, touch  (right arrow), touch **Setup**, and then touch **Network**.
2. Touch **Restore Network Defaults**, and then touch **Yes**.
A message appears stating that the network defaults have been restored.

 **NOTE:** Print the network configuration page and verify that the network settings have been reset. For more information, see [Understand the network configuration page](#).

Uninstall and reinstall the HP software

If your installation is incomplete, or if you connected the USB cable to the computer before prompted by the HP software installation screen, you might need to uninstall and then reinstall the HP software that came with the printer. Do not simply delete the printer application files from your computer.

To uninstall from a Windows computer:

1. On the computer desktop, click **Start**, select **Settings**, click **Control Panel**, and then click **Add/Remove Programs**.
- Or -
Click **Start**, click **Control Panel**, and then double-click **Programs and Features**.
2. Select the printer name, and then click **Change/Remove** or **Uninstall/Change**.
Follow the onscreen instructions.
3. Disconnect the printer from your computer.
4. Restart your computer.

 **NOTE:** It is important that you disconnect the printer before restarting your computer. Do not connect the printer to your computer until after you have reinstalled the HP software.

5. Insert the HP software CD into your computer's CD drive and then start the Setup program.
6. Follow the onscreen instructions.

To uninstall from a Macintosh computer:

1. Double-click the **HP Uninstaller** icon (located in the **Hewlett-Packard** folder in the **Applications** folder at the top level of the hard disk), and then click **Continue**.
2. When prompted, type the correct administrator's name and password, and then click **OK**.
3. Follow the onscreen instructions.
4. When the **HP Uninstaller** finishes, restart your computer.

E Printer management tools

This section contains the following topics:

- [Toolbox \(Windows\)](#)
- [HP Utility \(Mac OS X\)](#)
- [Embedded web server](#)

Toolbox (Windows)

The Toolbox provides maintenance information about the printer.

 **NOTE:** The Toolbox can be installed from the HP Software CD if the computer meets the system requirements.

Open the Toolbox

1. On the computer desktop, click **Start**, select **Programs** or **All Programs**, click **HP**, click the folder for your printer, and then select the icon with your printer's name.
2. Double-click **Printer Preferences**, and then double-click **Maintenance Tasks**.

HP Utility (Mac OS X)

HP Utility contains tools to configure print settings, calibrate the printer, order supplies online, and find web site support information.

 **NOTE:** The features available in HP Utility vary depending on the selected printer. Ink level warnings and indicators provide estimates for planning purposes only. When you receive a low-ink warning message, consider having a replacement cartridge available to avoid possible printing delays. You do not need to replace cartridges until prompted to do so.

To open HP Utility

Double-click the HP Utility icon. This icon is located in the **Hewlett-Packard** folder in the **Applications** folder at the top level of the hard disk.

Embedded web server

When the printer is connected to a network, you can use the printer's home page (embedded web server or EWS) to view status information, change settings, and manage it from your computer.

 **NOTE:** For a list of system requirements for the embedded web server, see [Embedded web server specifications](#).

To view or change some settings, you might need a password.

You can open and use the embedded web server without being connected to the Internet. However, some features are not available.

This section contains the following topics:

- [About cookies](#)
- [To open the embedded web server](#)

About cookies

The embedded web server (EWS) places very small text files (cookies) on your hard drive when you are browsing. These files let the EWS recognize your computer the next time you visit. For

example, if you have configured the EWS language, a cookie helps remember which language you have selected so that the next time you access the EWS, the pages are displayed in that language. Though some cookies are cleared at the end of each session (such as the cookie that stores the selected language), others (such as the cookie that stores customer-specific preferences) are stored on the computer until you clear them manually.

You can configure your browser to accept all cookies, or you can configure it to alert you every time a cookie is offered, which allows you to decide which cookies to accept or refuse. You can also use your browser to remove unwanted cookies.



NOTE: Depending on your printer, if you disable cookies, you also disable one or more of the following features:

- Starting where you left the application (especially useful when using setup wizards)
- Remembering the EWS browser language setting
- Personalizing the EWS Home page

For information about how to change your privacy and cookie settings and how to view or delete cookies, see the documentation available with your web browser.

To open the embedded web server



NOTE: The printer must be on a network and must have an IP address. The IP address and hostname for the printer are listed on the status report. For more information, see [Understand the network configuration page](#).

In a supported web browser on your computer, type the IP address or hostname assigned to the printer.

For example, if the IP address is 123.123.123.123, type the following address into the web browser: `http://123.123.123.123`



TIP: After opening the embedded web server, you can bookmark it so that you can return to it quickly.

TIP: If you are using the Safari web browser in Mac OS X, you can also use the Bonjour bookmark to open the EWS without typing the IP address. To use the Bonjour bookmark, open Safari, and then from the **Safari** menu, click **Preferences**. On the **Bookmarks** tab, in the **Bookmarks** bar section, select **Include Bonjour**, and then close the window. Click the **Bonjour** bookmark, and then select your networked printer to open the EWS.

F How do I?

- [Get started](#)
- [Print](#)
- [Scan](#)
- [Copy](#)
- [Fax](#)
- [Web Services](#)
- [Work with ink cartridges](#)
- [Solve a problem](#)

G Errors (Windows)

Fax memory full

If Backup Fax Reception or HP Digital Fax (Fax to PC or Fax to Mac) is enabled and the printer has a problem (such as a paper jam), the printer saves incoming faxes to memory until the problem is resolved. However, the printer's memory might fill up with faxes that have not been printed yet or transferred to the computer.

To solve this problem, resolve any problems with the printer.

For more information, see [Solve fax problems](#).

Unable to communicate with printer

The computer cannot communicate with the printer because one of the following events has occurred:

- The printer has been turned off.
- The cable connecting the printer, such as a USB cable, has been disconnected.
- If the printer is connected to a wireless network, the wireless connection has been broken.

To solve this problem, try the following solutions:

- Make sure the printer is turned on and that the  (Power) light is on.
- Make sure the power cord and other cables are working and are firmly connected to the printer.
- Make sure the power cord is connected firmly to a functioning, alternating current (AC) power outlet.

Low on ink

The ink cartridge identified in the message is low on ink.

Ink level warnings and indicators provide estimates for planning purposes only. When you receive a low ink warning message, consider having a replacement cartridge available to avoid possible printing delays. You do not need to replace cartridges until prompted to do so.

For information about replacing ink cartridges, see [Replace the ink cartridges](#). For information about ordering ink cartridges, see [Order printing supplies online](#). For information about recycling used ink supplies, see [HP inkjet supplies recycling program](#).

 **NOTE:** Ink from the cartridges is used in the printing process in a number of different ways, including in the initialization process, which prepares the printer and cartridges for printing. In addition, some residual ink is left in the cartridge after it is used. For more information see www.hp.com/go/inkusage.

Cartridge Problem

The ink cartridge identified in the message is missing, damaged, incompatible, or inserted into the wrong slot in the printer.

 **NOTE:** If the cartridge is identified in the message as incompatible, see [Order printing supplies online](#) for information about obtaining cartridges for the printer.

To solve this problem, try the following solutions. Solutions are listed in order, with the most likely solution first. If the first solution does not solve the problem, continue trying the remaining solutions until the issue is resolved.

- Solution 1: Turn the printer off and on.
- Solution 2: Install the ink cartridges correctly.

Solution 1: Turn the printer off and on

Turn off the printer, and then turn it on again.

If the problem persists, try the next solution.

Solution 2: Install the ink cartridges correctly

Make sure all of the ink cartridges are properly installed:

1. Gently pull open the ink cartridge access door.
2. Remove the ink cartridge by pushing it in to release it, and then pulling it firmly toward you.
3. Insert the cartridge into the slot. Press firmly on the cartridge to ensure proper contact.
4. Close the ink cartridge access door and check if the error message has gone away.

Replace the ink cartridge

Replace the indicated ink cartridge. For more information, see [Replace the ink cartridges](#).

 **NOTE:** If your cartridge is still under warranty, contact HP support for service or replacement. For more information about ink cartridge warranty, see [Ink cartridge warranty information](#). If the problem persists after you replace the cartridge, contact HP support. For more information, see [HP support](#).

Paper Mismatch

The paper size or type selected in the printer driver does not match the paper loaded in the printer. Make sure that the correct paper is loaded in the printer, and then print the document again. For more information, see [Load media](#).

 **NOTE:** If the paper loaded in the printer is the correct size, change the selected paper size in the printer driver, and then print the document again.

The cartridge cradle cannot move

Something is blocking the ink cartridge cradle (the part of the printer that holds the ink cartridges).

To clear the obstruction, press  (Power) button to turn off the printer, and then check the printer for jams.

For more information, see [Clear jams](#).

Paper Jam

Paper has become jammed in the printer.

Before you try to clear the jam, check the following:

- Make sure that you have loaded paper that meets specifications and is not wrinkled, folded, or damaged. For more information, see [Media specifications](#).
- Make sure that the printer is clean. For more information, see [Maintain the printer](#).
- Make sure that the trays are loaded correctly and are not too full. For more information, see [Load media](#).

For instructions on clearing jams, as well as more information about how to avoid jams, see [Clear jams](#).

The printer is out of paper

The default tray is empty.

Load more paper, and then touch **OK**.

For more information, see [Load media](#).

Printer Offline

The printer is currently offline. While offline, the printer cannot be used.

To change the printer's status, complete the following steps.

1. Click **Start**, and then click **Printers** or **Printers and Faxes** or **Devices and Printers**.
- Or -
Click **Start**, click **Control Panel**, and then double-click **Printers**.
2. If the printers listed in the dialog box are not being displayed in Details view, click the **View** menu, and then click **Details**.
3. If the printer is Offline, right-click the printer, and click **Use Printer Online**.
4. Try using the printer again.

Printer Paused

The printer is currently paused. While paused, new jobs are added to the queue but are not printed.

To change the printer's status, complete the following steps.

1. Click **Start**, and then click **Printers** or **Printers and Faxes** or **Devices and Printers**.
- Or -
Click **Start**, click **Control Panel**, and then double-click **Printers**.
2. If the printers listed in the dialog box are not being displayed in Details view, click the **View** menu, and then click **Details**.
3. If the printer is paused, right-click the printer, and click **Resume Printing**.
4. Try using the printer again.



Document failed to print

The printer could not print the document because a problem occurred in the printing system.

For information about solving printing problems, see [Solve printer problems](#).

Printer failure

There was a problem with the printer. Usually, you can resolve such problems by completing the following steps:

1. Press  (Power) button to turn off the printer.
2. Unplug the power cord, and then plug in the power cord again.
3. Press  (Power) button to turn on the printer.

If this problem persists, write down the error code provided in the message, and then contact HP support. For more information about contacting HP support, see [HP support](#).

Door or cover open

Before the printer can print documents, all doors and covers must be closed.

 **TIP:** When completely closed, most doors and covers snap into place.

If the problem persists after you've securely closed all doors and covers, contact HP support. For more information, see [HP support](#).

Previously used ink cartridge installed

The ink cartridge identified in the message was previously used in a different printer.

You can use ink cartridges in different printers, but if the cartridge was left outside of a printer for an extended period of time, the print quality of your documents might be affected. Also, if you use ink cartridges that have been used in a different printer, the ink level indicator might be inaccurate or unavailable.

If the print quality is unsatisfactory, try cleaning the printheads.

 **NOTE:** Ink from the cartridges is used in the printing process in a number of different ways, including in the initialization process, which prepares the printer and cartridges for printing, and in printhead servicing, which keeps print nozzles clear and ink flowing smoothly. In addition, some residual ink is left in the cartridge after it is used. For more information, see www.hp.com/go/inkusage.

For more information about storing ink cartridges, see [Supplies](#).

Ink cartridges depleted

The cartridges listed in the message must be replaced to resume printing. HP recommends that you do not remove an ink cartridge until a replacement is ready to install.

For more information, see [Replace the ink cartridges](#).

Ink cartridge failure

The cartridges listed in the message are damaged or have failed.

See [Replace the ink cartridges](#).

Printer supply upgrade

The cartridge listed in the message can only be used to upgrade one printer. Click OK to use it on this printer. If you do not wish to proceed with the supply upgrade for this printer, click Cancel Print and then remove the cartridge.

Printer supply upgrade successful

The supply upgrade was successful. The cartridges listed in the message can now be used in the printer.

Printer supply upgrade problem

The supply upgrade was not successful. The cartridges listed in the message can still be used in this printer. Replace the Supply Upgrade cartridge. For more information, see [Replace the ink cartridges](#).

Non-HP ink cartridges installed

HP cannot guarantee the quality or reliability of non-HP supplies. Printer service or repairs required as a result of using a non-HP supply will not be covered under warranty. If you believe you purchased original HP ink cartridges, visit HP at www.hp.com/go/anticounterfeit for more information or to report fraud.

Using Original HP Cartridges has its Rewards

HP rewards loyal customers for using original HP supplies. Click the button below the message to view Rewards online. Reward may not be available in all regions.

Counterfeit Cartridge Advisory

The installed cartridge is not a new, original HP cartridge. Contact the store where this cartridge was purchased. To report suspected fraud, visit HP at www.hp.com/go/anticounterfeit. To continue using the cartridge, click Continue.

Used, Refilled or Counterfeit Cartridge Detected

The original HP ink in the cartridge has been depleted. The solution for this problem is to replace the ink cartridge or click OK to continue using the cartridge. For more information, see [Replace the ink cartridges](#). HP rewards loyal customers for using original HP supplies. Click the button below the message to view Rewards online. Rewards may not be available in all regions.

⚠ WARNING! HP's ink cartridge warranty does not cover non-HP ink or cartridges. HP's printer warranty does not cover repairs or service due to use of non-HP cartridges or ink. HP does not guarantee the quality or reliability of non-HP ink. Information about ink levels will not be available.

Use SETUP cartridges

Use the SETUP cartridges that came with the printer for printer initialization. You must replace the cartridge with the setup cartridge to clear this message. For more information, see [Replace the ink cartridges](#).

Do not use SETUP cartridges

SETUP cartridges cannot be used after the printer has been initialized. Remove and install non-SETUP cartridges. For more information, see [Replace the ink cartridges](#).

New printhead ink alert

The used cartridges listed in the message might not have enough ink to complete one-time startup processes.

Solution: Install new cartridges or click **Continue** to use installed cartridges.

If startup cannot complete with installed cartridges, new cartridges will be needed. For information on how to install new cartridges, see [Replace the ink cartridges](#).

Use black ink only?

The cartridges listed in the message are out of ink.

Solutions: To print in color, replace the empty cartridges. For information about how to install new cartridges, see [Replace the ink cartridges](#).

To temporarily print using Black ink only, click **Use Black Only**. The printer will replace color with grayscale. The empty cartridges will need to be replaced soon.

⚠ CAUTION: Do **NOT** remove the empty color cartridge to print in **Use Black Only** mode.

Use color ink only?

The black cartridge is out of ink.

Solutions: To temporarily replace black with color, click **Use Color Only**. Black will be simulated. Text and photo quality will differ from those printed when using all cartridges. The black cartridge will need to be replaced soon.

To print with black, replace the black ink cartridge. For information about how to install new cartridges, see [Replace the ink cartridges](#).

⚠ CAUTION: Do **NOT** remove the empty black cartridge to print in **Use Color Only** mode.

Incompatible ink cartridges

The ink cartridge is not compatible with your printer.

Solution: Remove this cartridge immediately and replace with a compatible ink cartridge. For information about how to install new cartridges, see [Replace the ink cartridges](#).

Ink sensor warning

The ink sensor is reporting an unexpected condition. This could be caused by the cartridge, or the sensor may have failed. If the sensor has failed, it can no longer sense when your cartridges are out of ink. Printing with an empty cartridge will cause air to enter the ink system, which causes poor print quality. Significant amounts of ink will be used up to recover from this condition, which will deplete much of the ink supply for all cartridges.

Solution: Click **OK** to continue printing or replace the cartridge. For information about how to install new cartridges, see [Replace the ink cartridges](#).

Problem with printer preparation

The printer clock has failed and ink preparation may not be complete. The estimated Ink Level gauge might be inaccurate.

Solution: Check the print quality of your print job. If it is not satisfactory, running the printhead cleaning procedure from the toolbox might improve it.

Color cartridge out of ink

The cartridges listed in the message are out of ink.

Solutions: To print in color, replace the empty cartridges. For information about how to install new cartridges, see [Replace the ink cartridges](#).

To temporarily print using black ink only, click Cancel Print and then re-send the print job. The **Use black ink only?** message appears before the job prints. The empty cartridges will need to be replaced soon.

⚠ CAUTION: Do **NOT** remove the empty color cartridge to print in **Use Black Only** mode.

Black cartridge out of ink

The black cartridge is out of ink.

Solutions: Replace the black ink cartridge. For information about how to install new cartridges, see [Replace the ink cartridges](#).

⚠ CAUTION: Do **NOT** remove the empty black cartridge to print in **Use Color Only** mode.

To temporarily replace black with color, click Cancel Print and re-send the print job. The **Use color ink only?** message appears before the job prints. The black cartridge will need to be replaced soon.

Automatic document feeder cover open

Close the cover of the Automatic Document Feeder to continue.

Problem with ink system

Please remove the ink cartridges and examine them for any sign of leaks. If any cartridges have leaks, contact HP. Do not use cartridges that are leaking.

If there are no leaks, re-install cartridges and close the printer cover. Turn the printer off then on again. If you get this message a second time, contact HP.

Index

A

- accessibility 3, 9
- accessories
 - printer status report 124
 - warranty 131
- acoustic emissions 141
- ADF (automatic document feeder)
 - load originals 19
 - media sizes supported 135
- ADSL, fax setup with
 - parallel phone systems 168
- after the support period 80
- align printhead 90
- answer ring pattern
 - change 59
 - parallel phone systems 170
- answering machine
 - fax tones recorded 111
 - set up with fax (parallel phone systems) 179
 - set up with fax and modem 180
- automatic document feeder (ADF)
 - clean 25
 - feeding problems, troubleshoot 25
 - load originals 19
 - media sizes supported 135
- automatic fax reduction 52

B

- backup fax 50
- baud rate 61
- black and white pages
 - copy 41
 - fax 43
- black dots or streaks, troubleshoot
 - copies 94
 - scan 99
- blank pages, troubleshoot
 - copy 93
 - print 83
 - scan 99

- blocked fax numbers
 - set up 52
- broadcast faxing
 - send 48
- buttons, control panel 12

C

- cancel
 - scheduled fax 48
- Cancel button 13
- capacity
 - trays 138
- cards
 - sizes supported 136
 - tray supporting 138
- cartridges. *See* ink cartridges
- clean
 - automatic document feeder 25
 - exterior 24
 - printhead 89
 - scanner glass 24
- clear
 - fax logs 64
- color copy 41
- colored text, and OCR 38
- computer modem
 - shared with fax (parallel phone systems) 173
 - shared with fax and answering machine (parallel phone systems) 180
 - shared with fax and voice line (parallel phone systems) 175
 - shared with fax and voice mail (parallel phone systems) 184
- Configure
 - firewall 119
- confirmation reports, fax 63
- connectors, locating 12
- control panel
 - buttons 12

- lights 12
- status icons 13

- Copy 13
 - copy
 - quality 94
 - settings 41
 - specifications 139
 - troubleshoot 92
 - copy settings
 - copy 42
 - correct port test, fax 101
 - custom-size paper
 - Mac OS 33
 - print on 32
 - custom-sized media
 - sizes supported 137
 - customer support
 - electronic 77
 - cut-off pages, troubleshoot 84
-
- D**
 - dark images, troubleshoot
 - copies 94
 - scans 99
 - default settings
 - copy 42
 - diagnostic page 87
 - dial tone test, failure 104
 - dial type, setting 60
 - dial-up modem
 - shared with fax (parallel phone systems) 173
 - shared with fax and answering machine (parallel phone systems) 180
 - shared with fax and voice line (parallel phone systems) 175
 - shared with fax and voice mail (parallel phone systems) 184
 - distinctive ringing
 - change 59
 - parallel phone systems 170

- dots or streaks, troubleshoot
 - copies 94
- dots, troubleshoot
 - scan 99
- driver
 - warranty 131
- DSL, fax setup with
 - parallel phone systems 168
- duty cycle 133

E

- ECM. *See* error correction mode
- edit
 - text in OCR program 38
- electrical specifications 141
- embedded web server
 - about 195
 - opening 196
 - system requirements 135
 - troubleshoot, cannot be opened 120
 - Webscan 37
- envelopes
 - sizes supported 136
 - tray supporting 138
- environmental
 - specifications 140
- environmental sustainability program 149
- error correction mode 48
- error messages
 - unable to activate TWAIN source 97
- error reports, fax 64
- EWS. *See* embedded web server

F

- faded copies 93
- faded stripes on copies, troubleshoot 94
- fax
 - answer mode 58
 - answering machine and modem, shared with (parallel phone systems) 180
 - answering machine troubleshoot 111

- answering machine, set up (parallel phone systems) 179
- auto answer 58
- backup fax 50
- blocking numbers 52
- confirmation reports 63
- dial tone test, failed 104
- dial type, setting 60
- distinctive ringing setup (parallel phone systems) 170
- distinctive ringing, change pattern 59
- DSL, set up (parallel phone systems) 168
- error correction mode 48
- error reports 64
- forwarding 51
- header 58
- Internet Protocol, over 62
- ISDN line, set up (parallel phone systems) 169
- line condition test, failed 105
- log, clear 64
- log, print 64
- manual receive 49
- modem and answering machine, shared with (parallel phone systems) 180
- modem and voice line, shared with (parallel phone systems) 175
- modem and voice mail, shared with (parallel phone systems) 184
- modem, shared with (parallel phone systems) 173
- monitor dialing 46, 48
- paper size 52
- parallel phone systems 164
- PBX system, set up (parallel phone systems) 169
- phone cord connection test, failed 101
- phone cord too short 111
- phone cord type test, failed 102
- poll to receive 51

- print last transaction
 - details 65
- receive 49
- receive, troubleshoot 106, 109
- redial options 60
- reduction 52
- reports 63
- reprint 50
- rings to answer 59
- schedule 47
- send 43
- send, troubleshoot 106, 108, 111
- separate line setup (parallel phone systems) 167
- settings, change 58
- setup types 165
- shared phone line setup (parallel phone systems) 171
- sound volume 61
- specifications 139
- speed 61
- test failed 100
- test setup 187
- troubleshoot 99
- voice mail, set up (parallel phone systems) 172
- wall jack test, failed 101

- Fax screen 13
- Firewall
 - configure 119
- firewalls, troubleshoot 82
- FoIP 62
- fonts supported 133
- forwarding faxes 51

G

- glass, scanner
 - clean 24
 - load originals 18
 - locating 11
- grainy or white bands on copies, troubleshoot 95
- graphics
 - incompletely filled on copies 94
 - look different from original scan 98

H

hardware, fax setup test 100
 head 89
 header, fax 58
 Help 13
 Hewlett-Packard Company notices 3
 HP Utility (Mac OS X)
 opening 195
 humidity specifications 140

I

ink cartridges
 check ink levels 72
 locating 11
 ordering online 162
 part numbers 124, 162
 replace 73
 status 124
 supported 133
 tips 71
 warranty 131
 warranty expiration dates 124
 yields 133
 ink level icons 14
 ink levels, check 72
 ink-cartridge access door, locating 11
 input tray
 capacity 138
 media sizes supported 135
 media types and weights supported 138
 installation
 hardware installation suggestions 122
 HP software installation suggestions 122
 troubleshooting issues 121
 Internet Protocol fax, using 62
 IP address
 checking for printer 121
 IP settings 193
 ISDN line, set up with fax
 parallel phone systems 169

J

jams
 clear 126

media to avoid 18
 paper 126, 128
 junk fax mode 52

L

language, printer 133, 134
 light images, troubleshoot
 copies 94
 scans 99
 lights, control panel 12
 line condition test, fax 105
 lines
 copies, troubleshoot 94
 scans, troubleshoot 98, 99
 link speed, setting 193
 load
 custom-size media 23
 photo 22
 tray 20, 21
 load cards 22
 load custom-size media 23
 load envelopes 21
 load media 20
 log, fax
 print 64

M

Mac OS
 custom-size paper 33
 Print borderless 34
 Print photos 32
 print settings 28
 Mac OS X
 HP Utility 195
 maintain
 printhead 89
 maintenance
 align printhead 90
 check ink levels 72
 clean printhead 89
 diagnostic page 87
 print quality report 87
 printhead 89
 replace ink cartridges 73
 manual faxing
 receive 49
 send 45, 46
 margins
 setting, specifications 138
 media
 clear jams 126
 HP, order 163

load tray 20
 print on custom-size 32
 selecting 18
 skewed pages 92
 specifications 135
 supported sizes 135
 troubleshoot feeding 91
 types and weights supported 138
 memory
 reprint faxes 50
 save faxes 50
 specifications 134
 missing or incorrect information, troubleshoot 83
 model number 124
 modem
 shared with fax (parallel phone systems) 173
 shared with fax and answering machine (parallel phone systems) 180
 shared with fax and voice line (parallel phone systems) 175
 shared with fax and voice mail (parallel phone systems) 184
 monitor dialing 46, 48
 multi-feeds, troubleshoot 92

N
 networks
 advanced settings 193
 connector illustration 12
 firewalls, troubleshoot 82
 IP settings 193
 link speed 193
 operating systems supported 134
 protocols supported 135
 settings, change 192
 solve problems 123
 system requirements 135
 view and print settings 193
 wireless communication setup 188
 wireless settings 124
 noise information 141

- O**
- OCR
 - edit scanned documents 38
 - troubleshoot 96
- operating environment
 - specifications 140
- operating systems
 - supported 134
- originals
 - scan 36
- output tray
 - locating 11
 - media supported 138
- P**
- pages per month (duty cycle) 133
- paper
 - jams 126, 128
 - size, set for fax 52
- paper-feed problems, troubleshoot 91
- parallel phone systems
 - answering machine
 - setup 179
 - countries/regions with 164
 - distinctive ringing setup 170
 - DSL setup 168
 - ISDN setup 169
 - modem and answering machine setup 180
 - modem and voice mail setup 184
 - modem setup 173
 - modem shared with voice
 - line setup 175
 - PBX setup 169
 - separate line setup 167
 - setup types 165
 - shared line setup 171
- PBX system, set up with fax
 - parallel phone systems 169
- PCL 3 support 133
- phone cord
 - connected to correct port
 - test failed 101
 - correct type test failed 102
 - extend 111
- phone line, answer ring
 - pattern 59
- phone support 77
- phone support period
 - period for support 78
- phone, fax from
 - receive 49
 - send, 45
- photo media
 - sizes supported 137
- Photo screen 13
- poll to receive fax 51
- ports, specifications 133
- power
 - specifications 141
 - troubleshoot 81
- power input, locating 12
- print
 - diagnostic page 87
 - fax logs 64
 - fax reports 63
 - faxes 50
 - last fax details 65
 - print quality report 87
 - printer status report 124
 - troubleshoot 80
- Print borderless
 - Mac OS 34
 - Windows 34
- Print brochures
 - print 29
- Print envelope 30
- Print envelopes
 - Mac OS 30
- Print photos
 - Mac OS 32
 - Windows 31
- print quality report 87
- print settings
 - print quality 85
- print-carriage access door, locating 11
- printer control panel
 - locating 11
 - network settings 192
 - scan from 36
 - send faxes 44
- printer driver
 - warranty 131
- printer software (Windows)
 - about 195
 - opening 195
- printer status report
 - information on 123
 - print 124
- printhead
 - clean 89
- printhead, align 90
- printheads
 - ordering online 162
- printing
 - slow, troubleshoot 82
- processor specifications 134
- pulse dialing 60
- Q**
- quality, troubleshoot
 - copy 94
 - scan 97
- R**
- radio interference
 - reducing 192
 - regulatory information 147
- radio, turn off 193
- rear access panel
 - clear jams 126
 - illustration 12
- receive faxes
 - auto answer mode 58
 - automatically 49
 - blocking numbers 52
 - forwarding 51
 - manually 49
 - polling 51
 - rings to answer 59
 - troubleshoot 106, 109
- recycle
 - print cartridges 149
- redial options, setting 60
- reduce fax 52
- regulatory information 142, 147
- regulatory model number 142
- replace ink cartridges 73
- reports
 - confirmation, fax 63
 - diagnostic 87
 - error, fax 64
 - fax test failed 100
 - print quality 87
 - printhead 89
- reprint
 - faxes from memory 50
- right navigation button 13
- rings to answer 59
- S**
- save
 - faxes in memory 50

Index

- scan
 - error messages 97
 - from printer control panel 36
 - from Webscan 37
 - OCR 38
 - quality 97
 - Scan screen 13
 - scan specifications 140
 - slow 96
 - troubleshoot 95
 - Scan screen 13
 - scanner glass
 - clean 24
 - load originals 18
 - locating 11
 - schedule fax 47
 - send faxes
 - basic fax 43
 - manually 45
 - memory, from 47
 - monitor dialing 46, 48
 - schedule 47
 - troubleshoot 106, 108, 111
 - send scans
 - for OCR 38
 - troubleshoot 95
 - serial number 124
 - serial phone systems
 - countries/regions with 164
 - setup types 165
 - settings
 - copy 41
 - network 192
 - speed, fax 61
 - volume, fax 61
 - Setup 13
 - setup
 - answering machine (parallel phone systems) 179
 - answering machine and modem (parallel phone systems) 180
 - computer modem (parallel phone systems) 173
 - computer modem and answering machine (parallel phone systems) 180
 - computer modem and voice line (parallel phone systems) 175
 - computer modem and voice mail (parallel phone systems) 184
 - distinctive ringing 59
 - distinctive ringing (parallel phone systems) 170
 - DSL (parallel phone systems) 168
 - fax scenarios 165
 - fax, with parallel phone systems 164
 - ISDN line (parallel phone systems) 169
 - PBX system (parallel phone systems) 169
 - separate fax line (parallel phone systems) 167
 - shared phone line (parallel phone systems) 171
 - test fax 187
 - voice mail (parallel phone systems) 172
 - voice mail and computer modem (parallel phone systems) 184
 - size
 - scans, troubleshoot 99
 - troubleshoot copy 93
 - skew, troubleshoot
 - copy 94
 - print 92
 - scan 98
 - software
 - OCR 38
 - warranty 131
 - Webscan 37
 - sound pressure 141
 - specifications
 - acoustic emissions 141
 - electrical 141
 - media 135
 - network protocols 135
 - operating environment 140
 - physical 133
 - processor and memory 134
 - storage environment 141
 - system requirements 134
 - speed
 - troubleshoot for scanner 96
 - speed dial
 - send fax 43
 - status
 - network configuration
 - page 124
 - printer status report 124
 - status icons 13
 - storage environment
 - specifications 141
 - streaks, troubleshoot
 - copies 94
 - scan 99
 - stripes on scans,
 - troubleshoot 98
 - subscriber identification code 58
 - supplies
 - ordering online 162
 - printer status report 124
 - yields 133
 - support 76
 - system requirements 134
- ## T
- technical information
 - copy specifications 139
 - fax specifications 139
 - scan specifications 140
 - telephone line, answer ring pattern 59
 - telephone wall jack, fax 101
 - telephone, fax from
 - receive 49
 - send 45
 - temperature specifications 140
 - tests, fax
 - dial tone, failed 104
 - failed 100
 - fax line condition 105
 - fax phone cord type test
 - failed 102
 - hardware, failed 100
 - port connection, failed 101
 - setup 187
 - telephone wall jack 101
 - text
 - cannot be edited after scan,
 - troubleshoot 96
 - incompletely filled on
 - copies 94
 - missing from scan,
 - troubleshoot 96
 - splotchy on copies 95
 - troubleshoot 84

- unclear on copies, troubleshoot 94
- unclear scans 99
- tone dialing 60
- tray 2
 - capacity 138
 - media sizes supported 135
 - media types and weights supported 138
- trays
 - capacities 138
 - clear jams 126
 - load media 20
 - locating 11
 - media sizes supported 135
 - media types and weights supported 138
 - paper guides illustration 11
 - troubleshoot feeding 91
- troubleshoot
 - answering machines 111
 - blank pages printed 83
 - copy 92
 - copy quality 94
 - cut-off pages, incorrect text or graphics placement 84
 - embedded web server 120
 - fax 99
 - fax dial tone test failed 104
 - fax hardware test failed 100
 - fax line test failed 105
 - fax phone cord connection test failed 101
 - fax phone cord type test failed 102
 - fax tests 100
 - fax wall jack test, failed 101
 - firewalls 82
 - jams, paper 128
 - media not picked up from tray 91
 - missing or incorrect information 83
 - multiple pages are picked 92
 - network configuration page 124
 - nothing prints 81
 - paper-feed problems 91
 - power 81
 - print 80
 - printer status report 123
 - receive faxes 106, 109

- scan 95
- scan quality 97
- send faxes 106, 108, 111
- skewed copies 94
- skewed pages 92
- tips 80
- troubleshooting
 - hardware installation suggestions 122
 - HP software installation suggestions 122
 - installation issues 121
 - solve network problems 123
 - wireless problems 114
- TWAIN
 - unable to activate source 97

U

- USB connection
 - port, locating 11, 12
 - specifications 133

V

- vertical stripes on copies, troubleshoot 94
- view
 - network settings 193
- voice mail
 - set up with fax (parallel phone systems) 172
 - set up with fax and computer modem (parallel phone systems) 184
- voltage specifications 141
- volume
 - fax sounds 61

W

- wall jack test, fax 101
- warranty 131
- web sites
 - accessibility information 3, 9
 - customer support 77
 - environmental programs 149
 - order supplies and accessories 162
 - supply yield data sheet 133
- Webscan 37

- white bands or stripes, troubleshoot
 - copies 94, 95
 - scans 98
- Windows
 - borderless 34
 - print brochures 29
 - Print photos 31
 - print settings 28
 - system requirements 134
- wireless communication
 - advanced wireless troubleshooting 115
 - basic wireless troubleshooting 114
 - radio, turn off 193
 - reducing interference 192
 - regulatory information 147
 - set up 188
- wireless connection icons 13

© 2014 Hewlett-Packard Development Company, L.P.
www.hp.com

